

ALHAN®



01-2012



KONVEYÖR PARÇALARI ve BANTLAR / CONVEYOR COMPONENTS & CHAINS

www.alhan-cagri.com



ÇAĞRI®
ENDÜSTRİ A.Ş.

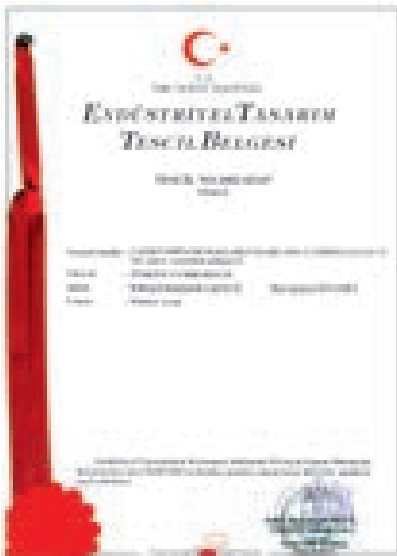



TÜRK MALI/MADE IN TURKEY



AR-GE BÖLÜMÜ/R-D DEPARTMENT

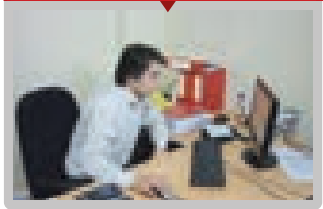

SATIŞ PAZARLAMA BÖLÜMÜ



MARKETING AND SALES DEPARTMENT

TANITIM/Introduction

ALHAN-ÇAĞRI 1978 yılında İstanbul'da mühendislik plastikleri ve makine imalatı için kurulmuş olup 1994 yılından itibaren konveyör parçaları ve hazır makine elemanları üzerine yoğunlaşarak artan teknolojik gelişmelere paralel olarak konveyör ve otomasyon sistemleri konusunda da anahtar teslimi projelere imza atarak Türkiye'de uzman kadrosuyla ilkleri gerçekleştirmeye devam etmektedir.

ALHAN-ÇAĞRI has established in İstanbul/Türkiye at 1978. Our company is the leading manufacturer as a conveyors, conveyor components and engineering plastics. We manufacture conveyor components since 1994 also conveyor system since 1997. Our trade mark is "**ALHAN**".

ÜRETİM/MANUFACTURING AREA

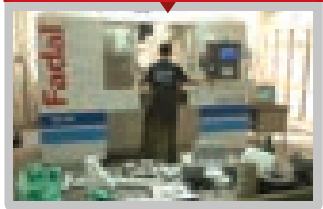

ÜRETİM/MANUFACTURING AREA



ÜRETİM/MANUFACTURING AREA

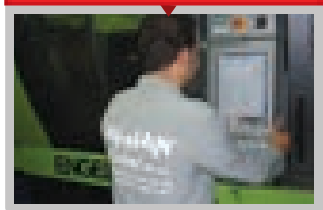

İhraç Edilen Ülkeler/Export Country



TEŞHİR MERKEZİ/SHOWROOM

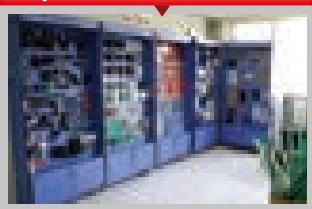

TEŞHİR MERKEZİ/SHOWROOM

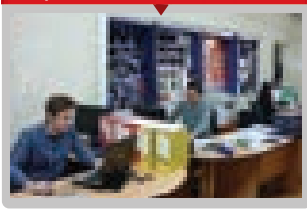

BİRLEŞTİRME/ASSEMBLY

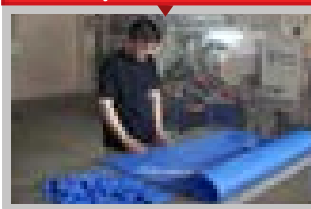

AMBAR/STORE

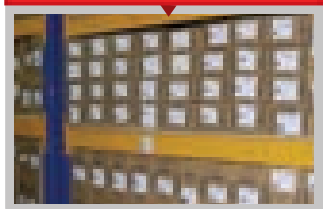

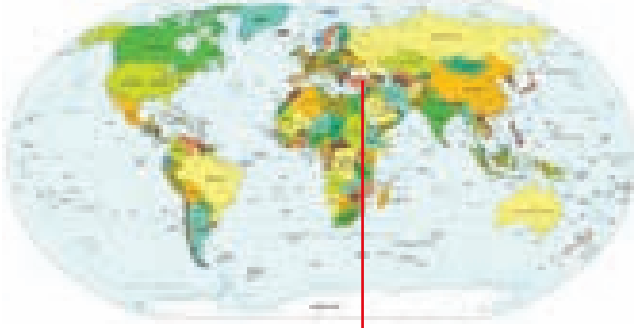
**Gültekinoğlu Salih ÖZBİDECİLER**

Kurucu-Şeref Başkanı/Founder-President
Makine Mühendisi/İşletmeci Mechanical Eng./B.A
gultekinoglu@alhan-cagri.com

Satış Sorumlusu/Sales Responsible
pazarlama@alhan-cagri.com



İhracat Sorumlusu/Export Responsible
export@alhan-cagri.com

Üretim Sorumlusu/Production Manager
uretim@alhan-cagri.com

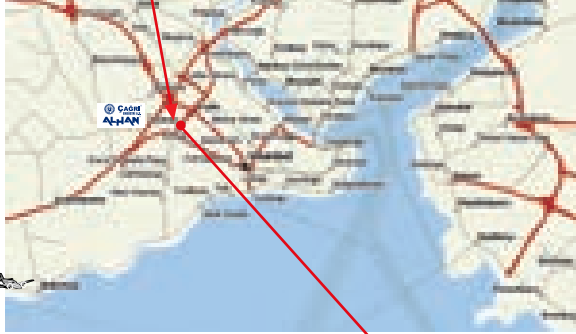

Muhasebe Sorumlusu/Accounting Responsible
muhasebe@alhan-cagri.com

Finans Sorumlusu/Finance Responsible
finans@alhan-cagri.com

Arge Sorumlusu/R&D Responsible
arge@alhan-cagri.com



Davutpaşa Cad./St. Nu:14/1 34010 Topkapı-İSTANBUL-TÜRKİYE

☎️: +90.212.444 00 42-544 50 55 Belgegeçer (Fax): +90.212.567 14 16-501 54 08

🌐: www.alhan-cagri.com e-posta/e-mail: info@alhan-cagri.com

İbrahim Ethem İlaç Fabrikası Yanı Ülker Fab. 150 mt. Gerisi MB İş Merkezi
From Airport:By light rail it will take appr. 15 min. to be in Davutpaşa station.
By Car or Taxi:Just near the Ülker factory in Davutpaşa area. MB Center

SEMBOLLER/SYMBOLS



Birlikte kullanılan bantın stok kodunu gösterir.
Chain's stock code



Birlikte kullanılan dişlinin yada kasnağın bulunduğu sayfayı gösterir.
Sprocket's or idler's pages

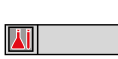

Standart parça
Standard parts



Kimyasal direnç tablosunun bulunduğu sayfayı gösterir.
Chemical resistance table's pages



Malzeme/Material



Dişlinin yada kasnağı iki parçalı olduğunu gösterir.
Two unit for sprocket's or idler's



Kolideki azami parça adet sayısı
Recommended packaging



Dikkat
Warning



Antistatik
Antistatic



Kauçuklu bant
Chains with rubber



Kauçuk Bant/Rubber Chains



Yapışmaz/Non-Adhesive



Belgegeçer/Fax



Ağırlık/Load



Asit/Acıt



Alüminyum/Aluminium



Çelik/Steel



Yeni Ürünler/New Products



3 Boyutlu Çizim için / For 3D Model
www.alhan-cagri.com

SEMBOLLER/SYMBOLS

ABS Akrilonitril Butain Sitrin
Acrilonitrile Butotiene Styrene



Polietilen / Polyethylene



Polipropilen / Polyproplene



Poliasetal / Polyacetal



Polivinilklorür/Poly Vinil Clorur



Polibütlen Tereflat/Polybutylene Terephthalate



Polyemid/Polyamide



Paslanmaz Çelik/Stainless Steel



Çinko Kaplama/Zinc



Zamak Metal Döküm/Die Cast Zamak Lever Body



Pirinç / Brass



Ağır Tip/Heavy Type



Hafif Tip/Easy Type

L: Bant genişliği/Belts width

P: Hatve/Pitch

Ri: Tırmanma radyusu/Back bend radius

RM: En az dönüş radyusu/Min. curve radius

Rd: Çalışma yönü/Running direction

A: Avara/Idler

T: Tahrik/Drive

Kg/m: Metre başına düşen kilogram/Kilograms per meter

mm: Milimetre/Millimeter

PIN: Pim/Pin

DF: Göbek mil çapı/Shaft diameter

DE: Diş üstü çapı/Outside diameter

DP: Kavrama çapı/Primitive diameter

UYARI WARNING	AÇIKLAMALAR KNOWLEDGES
1	Yüklemeye bağlı olarak (AV) pabuç yükseklikleri 1-1.5 mm artmaktadır. (AV) Feets length increases 1-1.5 mm as a result of loadind.
2	Stok kodlarına PP ekleyerek polipropilen tabanlı pabuç isteyebilirsiniz. Despite of (PP) adding to Stock Code you can give your request for polyproplene feets. 501 400 880 → PA 501 400 880 PP → PP

Katalogtaki ürünleri tasarımları değişikliğe uğrayabilir ve değişiklikten doğabilecek sorunlardan firmamız sorumlu değildir.
In catalogue, our product's design will be changed and as a result of this we have no response.



KOD/CODE	SAYFA PAGE	KOD/CODE	SAYFA PAGE	KOD/CODE	SAYFA PAGE	KOD/CODE	SAYFA PAGE	KOD/CODE	SAYFA PAGE	KOD/CODE	SAYFA PAGE		
184 3G0 031		206 BSA 001	B3	206 YD3 001		207 CC5 015		207 B31 930		207 H15 012		207 VP0 012	E16
184 3G0 082		206 BSA 002		206 YD3 002	E7	207 CC5 014	E6	207 UCD 036		207 H15 112		207 CTV 020	
184 3K0 031		206 LMY 520		206 YU1 001		207 CC5 016		207 UCD 045		207 H15 058		207 CTV 120	
184 3K0 082		206 LMS 520		206 YU1 002		207 CC6 012		207 UCD 050		207 H15 158		207 CTV 025	
187 3G0 057		206 LMY 325		206 YU2 001		207 OT2 012		207 UCD 056		207 H15 034		207 CTV 030	
187 3G0 082		206 LMS 325		206 YU2 002		207 OT2 058		207 UCD 085		207 H15 134		207 CTV 035	
187 3G0 114		206 LMY 525		206 BSA 101		207 OT2 034	E8	207 UCC C25		207 H20 100		207 CTV 040	
187 3G0 152		206 LMS 525		206 BSA 102	E8	207 OT2 100		207 UCC P25		207 H20 101		207 CTO 015	E17
187 3G0 190		206 LMY 330		206 BSA 201		207 OT2 114		207 UCC C30		207 H15 100	E14	207 CTO 115	
187 3G0 254	D19	206 LMS 330		206 BSA 202		207 OTO 038		207 UCC P30		207 H15 101		207 CTO 020	
187 3G0 304		206 LMY 530		206 BSA 001		207 OTO 012		207 UCC C33		207 H25 114		207 CTO 120	
187 3K0 057		206 LMS 530		206 BSA 002		207 OTO 112		207 UCC P33	E11	207 H25 214		207 CTO 025	
187 3K0 082		206 LMY 335		206 APC 040		207 OTO 058		207 UCC C38		207 H25 212		207 CTO 125	
187 3K0 114		206 LMS 335		206 APC 041		207 OTO 158		207 UCC P38		207 H25 134		207 CTO 225	
187 3K0 152		206 LMY 535		206 APC 042	E8	207 OTO 034		207 UCC C51		207 H25 234		207 CTO 030	
187 3K0 190		206 LMS 535		206 AGC 040		207 OTO 134		207 UCC P51		207 H25 200		207 CY1 001	
187 3K0 254		206 LMY 340	E3	206 BSC 040		207 OTO 100		207 TCG C38		207 H25 201		207 CY1 002	
187 3K0 304		206 LMS 340		206 BSC 041		207 OTO 101		207 TCG P38		207 KDC 001		207 GKR 138	
202 863 082		206 LMY 540		206 DON 001		207 OTO 114		207 TCG C12		207 KDP 002		207 GKR 112	
202 863 114		206 LMS 540		206 DON 002	D77	207 OTO 214		207 TCG P12		207 YDC 038		207 GKR 158	
202 863 190	E22	206 LMY 345		206 DON 003		207 OTO 412	E9	207 TCG C58		207 YDP 038		207 GKR 134	E21
202 863 254		206 LMS 345		206 OOZ 003		207 OT2 038		207 TCG P58		207 YDC 012		207 GKR 101	
202 863 304		206 LMY 545		206 OOZ 002		207 OT0 434		207 TCG C34		207 YDP 012		207 GKR 138	
202 880 082		206 LMS 545		206 OOZ 005		207 OT0 200		207 TCG P34		207 YDC 058		207 GKR 112	
202 880 114		206 LYS 350		206 OOZ 004		207 1TT C38		207 CCZ 038		207 YDP 058		207 GKR 158	
202 880 190		206 LMS 350		206 LMY 315	E3	207 1TT P38		207 CCZ 138		207 YDC 034	E15	207 GKR 134	
202 88T 082		206 LYS 550		206 LMS 315		207 1TT C12		207 CCZ 012		207 YDC 034		207 GKR 101	
202 88T 114	E23	206 LMS 550		206 LMY 515		207 1TT P12		207 CCZ 112		207 DYC 038		207 GKR 208	
202 88T 190		206 OGZ 001		206 LMS 515		207 1TT C58		207 CCZ 058		207 DYP 038		207 GKR 212	
202 882 190		206 OGZ 003		206 LMY 320		207 1TT P58		207 CCZ 158		207 DYC 012		207 GKR 258	
202 882 254		206 OGZ 002		206 LMS 320		207 1TT C34		207 CCZ 034		207 DYP 012		207 GKR 234	E3
202 882 304		206 OGZ 004		206 P03 818		207 1TT P34		207 CCZ 134		207 DYC 058		207 GKR 208	
204 112 610	E28	206 GLA 100		206 C03 818		207 1TT C01		207 CCZ 100		207 DYP 058		207 GKR 212	
204 114 610		206 GLA 101		206 C03 024		207 1TT P01		207 CCZ 101	E12	207 DYC 034		207 GKR 258	
205 500 182		206 GLA 102		206 C03 024	E20	207 TH2 510		207 BLO 038		207 DYP 034		207 GKR 234	
205 500 282		206 GLA 103		206 C04 540		207 TH3 510		207 BL1 012		207 CC0 004		207 YD4 060	
205 500 382		206 GLA 104		206 P04 540		207 TH4 010		207 BL2 058		207 CP0 004		207 YD4 066	E20
205 500 482		206 GLA 105		206 C06 020		207 TH4 015		207 BL3 034		207 CC0 005		207 YD4 060	
205 610 082		206 GLA 106		206 P06 020		207 TH4 510		207 BL4 001		207 CCP 005		207 YD4 066	
205 650 182		206 GLA 107	E4	207 HCP 011		207 TH4 515		207 BL5 114		207 CC0 006		210 DTT 010	
205 650 282		206 GLA 108		207 HCC 014		207 TA4 815		207 BL6 112		207 CCP 006		210 DTT 012	
205 650 382		206 GLA 109		207 HCP 014		207 TA4 820		207 BL7 134		207 CC0 008		210 DTT M10	
205 650 482		206 OOL 001		207 HCC 017		207 TA5 515	E10	207 BL8 002		207 CCP 008		210 DTT M12	
205 650 281		206 OOL 002		207 HCP 017		207 TA5 520		207 CUO 038		207 CC0 010		210 GTT 010	
205 650 282	E25	206 OOL 003		207 HCC 022		207 TA7 220		207 CUO 138		207 CCP 010		210 GTT 012	
205 650 283		206 OOL 013		207 HCP 022		207 TA8 920		207 CUO 012		207 CC0 012		210 GTT M10	
205 650 284		206 OOL 014		207 HCC 015		207 TA8 921		207 CUO 112		207 CCP 012		210 GTT M12	
205 550 114		206 OOL 015		207 HCP 015		207 OTT 001		207 CUO 058		207 CC0 015		210 DTY 008	
205 550 214		206 OOT 003		207 HCC 018		207 OTT 002		207 CUO 158		207 CCP 015	E16	210 DTY 010	
205 550 314		206 OOT 004		207 HCP 018		207 OTT 003		207 CUO 034		207 CC0 020		210 DTY 012	
205 550 414		206 UOT 001	E5	207 HCC 024	E6	207 OTT 004		207 CUO 134	E13	207 CCP 020		210 DTY M08	E6
205 610 114		206 UOT 002		207 HCP 024		207 OTT 005		207 CUO 100		207 VCO 004		210 DTY M10	
205 650 114		206 DOT 001		207 HCC 122		207 B33 510		207 CUO 101		207 VP0 004		210 DTY M12	
205 650 214		206 DOT 002		207 HCP 122		207 B34 510		207 CUO 038		207 VCO 005		210 DTF M08	
205 650 314		206 OKT 401		207 HCC 124		207 B34 515		207 OU1 012		207 VP0 005		210 DTF M10	
205 650 414		206 OKT 402		207 HCP 124		207 B34 520		207 OU2 058		207 VCO 006		210 DTF M12	
205 610 119		206 OKT 431		207 HCC 030		207 B35 510	E11	207 OU3 034		207 VP0 006		210 DTY A04	
205 650 119		206 OKT 432	E7	207 HCP 030		207 B36 510		207 OU4 001		207 VCO 008		210 DTF A04	
206 BSA 101		206 OKT 441		207 HCC 130		207 B39 515		207 TUO 001		207 VP0 008		210 011 100	
206 BSA 102	B3	206 OKT 442		207 HCP 130		207 B39 215		207 TUO 002		207 VCO 010		210 010 161	
206 BSA 201		206 OKT 461		207 CC3 012		207 B31 120		207 H15 038	E14	207 VP0 010		210 IIB 004	
206 BSA 202		206 OKT 462		207 CC4 010		207 B31 925		207 H15 138		207 VCO 012		210 012 128	

KOD/CODE	SAYFA PAGE	KOD/CODE	SAYFA PAGE	KOD/CODE	SAYFA PAGE	KOD/CODE	SAYFA PAGE	KOD/CODE	SAYFA PAGE	KOD/CODE	SAYFA PAGE		
210 012 208		21550	B14	215 502 482		220 100 125		230 401 220		243 HPL 204		245 TPL 208	B31
210 012 121		21560		215 502 582		220 100 225		230 401 620		243 HPL 205		245 NFL 204	
210 012 201	E6	215 000 103		215 502 682		220 120 125		230 501 215		243 HPL 206		245 NFL 205	
210 012 122BS		215 001 103		215 612 182		220 120 225		230 502 015		243 HPL 207		245 NFL 206	B33
210 012 202 BS		215 002 103		215 612 282		220 610 130		230 501 220		243 HPL 208	B30	245 NFL 207	
210 012 122		215 000 101	B15	215 612 382		220 610 230		230 501 620	A13	243 FBL 204		245 NFL 208	
210 012 123		215 000 105		215 612 482		220 800 130	E26	230 502 020		243 FBL 205		245 NFL 208	
210 122 100		215 001 101		215 612 582		220 800 230		230 501 225		243 FBL 206		245 LFL 204	
210 222 100	E8	215 000 102		215 612 682		220 100 130		230 501 625		243 FBL 207		245 LFL 205	B32
210 322 100		215 000 106		215 802 182		220 100 230		230 502 025		243 TPL 204		245 LFL 206	
210 D06 224		215 000 102		215 802 282		220 116 130		230 601 620		243 TPL 205		245 LFL 207	
210 D08 224		215 500 182		215 802 382		220 120 130		230 602 020		243 TPL 206		245 PPL 204	
210 D10 224		215 500 282		215 802 482		220 120 230		235 381 510		243 TPL 207		245 PPL 205	
210 D12 224	E8	215 500 382		215 802 582		220 KSK 856		235 381 512		243 TPL 208	B31	245 PPL 206	B32
210 D06 024		215 500 482		215 802 682		220 KSK 855	E27	235 381 514		243 LFL 204		245 PPL 207	
210 D08 024		215 500 582		215 102 182		220 611 873		235 381 516		243 LFL 205		245 PPL 208	
210 D10 024		215 500 682		215 102 282		220 801 873	E28	235 421 510		243 LFL 206		245 TBL 204	
210 D12 024		215 610 182		215 102 382		220 211 110		235 424 512		243 LFL 207		245 TBL 205	
210 E06 215		215 610 282		215 102 482		220 211 111	A15	235 424 514		243 PPL 204		245 TBL 206	B33
210 E06 220		215 610 382		215 102 582	E24	220 211 120		235 424 516		243 PPL 205		245 TBL 207	
210 E08 220		215 610 482		215 102 682		221 611 873		235 424 520		243 PPL 206		245 TBL 208	
210 E08 225		215 610 582		215 500 114		221 801 873		235 481 512		243 PPL 207		245 UCZ 204	
210 E08 230		215 610 682		215 500 214		222 611 873		235 481 514	A14	243 PPL 208	B32	245 UCZ 205	
210 E10 225		215 800 182		215 610 114		222 801 873	E28	235 481 516		243 FPL 204		245 UCZ 206	
210 E10 230		215 800 282		215 610 214		223 611 873		235 481 520		243 FPL 205		245 UCZ 207	
210 E12 225	B8	215 800 382		215 800 114		223 801 873		235 482 012		243 FPL 206		245 UCZ 208	
210 E12 230		215 800 482		215 800 214		224 611 873		235 482 014		243 FPL 208		245 UCS 204	
210 E06 015		215 800 582		215 100 114		224 801 873		235 482 016		243 NFL 204		245 UCS 205	
210 E06 020		215 800 682		215 100 214		225 150 082		235 482 020		243 NFL 205		245 UCS 206	
210 E08 020		215 100 182		215 500 219		225 150 182		235 482 024		243 NFL 206		245 UCS 207	B34
210 E08 025		215 100 282		215 500 219		225 150 282		235 602 016		243 NFL 207		245 UCS 208	
210 E08 030		215 100 382		215 610 119		225 250 082	E27	235 602 020		243 NFL 208		245 UCF 204	
210 E10 025		215 100 482		215 610 219		225 500 082		235 602 024		243 TBL 204	B33	245 UCF 205	
210 E10 030		215 100 582		215 800 119		225 630 082		235 602 516		243 TBL 205		245 UCF 206	
210 E12 025		215 100 682		215 800 219		226 150 082		235 602 520		243 TBL 206		245 UCF 206	
210 E 12 030		215 501 182	E24	215 100 119		226 500 182		240 021 170		243 TBL 207		245 OOF 204	
210 410 200		215 501 282		215 100 219		230 250 815		240 021 180	B27	243 TBL 208		245 OOF 205	
210 010 200	B9	215 501 382		215 610 114		230 251 015		240 021 200		244 HPL 204		245 OOF 206	
210 010 201		215 501 482		215 610 214		230 251 215		241 200 006		244 HPL 205		245 CFL 204	
210 110 100		215 501 582		215 800 114		230 300 815		241 200 008		244 HPL 206	B30	245 CFL 205	
210 110 200		215 501 682		215 800 214		230 301 015		241 200 010		244 HPL 207		245 CFL 206	
210 110 300	B10	215 611 182		215 100 114	E26	230 301 215		241 200 012		244 HPL 208		245 RFL 206	B35
210 100 200		215 611 282		215 100 214		230 301 615		241 400 006		244 TPL 205		245 RPL 206	
210 100 300		215 611 382		215 120 114		230 301 020		241 400 008		244 TPL 206	B31	245 KAP 204	
210 410 300		215 611 482		215 120 114		230 301 220		241 400 010		244 TPL 207		245 KAP 205	
210 410 100	E9	215 611 582		216 100 103	B27	230 301 620		241 400 012		244 TPL 208		245 KAP 206	
210 IDT 200		215 611 682		216 100 001		230 351 015		241 600 006		244 TPL 207		245 FPL 204	
210 ICB SLU		215 801 182		216 100 203	B28	230 351 215	A13	241 600 008		244 TPL 208		245 FPL 205	
210 ICB SLV		215 801 282		216 100 002		230 351 615		241 600 010	B17	244 PPL 204	B32	245 FPL 206	B32
210 ICB SLY		215 801 382		216 SKA 000	E16	230 351 020		241 600 012		244 PPL 205		245 FPL 207	
211 60P D04	B5	215 801 482		220 610 119		230 351 220		241 100 006		245 HPL 204		245 FPL 208	
211 60P MLL		215 801 582		220 610 219		230 351 620		241 100 008		245 HPL 205		246 HPL 204	
214 154 010	B21	215 801 682		220 800 119		230 381 016		241 100 010		245 HPL 206		246 HPL 205	
214 254 012		215 101 182		220 800 219		230 381 216		241 100 012		245 HPL 207	B30	246 HPL 206	B30
215 UKK PA6		215 101 282		220 100 119		230 381 616		241 300 006		245 HPL 208		246 HPL 207	
215 UKK 200		215 101 382		220 100 219	E26	230 381 030		241 300 008		245 FBL 204		246 HPL 208	
215 UKK 300	B13	215 101 482		220 120 119		230 381 230		241 300 010		245 FBL 205		246 TPL 204	
215 UKK 400		215 101 582		220 120 219		230 381 630		241 300 012		245 FBL 206		246 TPL 205	
215 UKK 500		215 101 682		220 610 125		230 401 015		241 500 006		245 FBL 207		246 TPL 206	
215 000 104		215 502 182		220 610 225		230 401 215		241 500 008		245 TPL 204		246 TPL 207	B31
215 001 104	B14	215 502 282		220 800 125		230 401 615		241 500 010		245 TPL 205	B31	246 TPL 208	
21540		215 502 382		220 800 225		230 401 020		241 500 012		245 TPL 206		246 TPL 206	
										245 TPL 207		246 TPL 207	

KOD/CODE	SAYFA PAGE	KOD/CODE	SAYFA PAGE	KOD/CODE	SAYFA PAGE	KOD/CODE	SAYFA PAGE	KOD/CODE	SAYFA PAGE	KOD/CODE	SAYFA PAGE		
246 TPL 208	B31	300 İTİ 125		312 TI1 225		320 AI2 423*		350 TI2 221		360 TIA 421*	D69	381 825 021	
246 PPL 204		300 İTİ 225		312 TI1 325	D56	320 TI2 125		350 TI2 321		360 TIO 123	D69	381 830 021	
246 PPL 205		300 İTİ 117	D54	312 TI1 425		320 TI2 225		350 ATT 121*		371 KDT 119		381 835 021	
246 PPL 206		300 İTİ 217		312 KI2 121		320 TI2 325	D60	350 ATT 221*		371 KDT 219		381 840 021	
246 PPL 207		302 019 103		312 KI2 221		320 TI2 425		350 ATT 321*		371 KDT 319		381 845 021	
246 PPL 208	B32	302 019 203		312 KI2 321		320 AI2 125*		350 TI2 123		371 KDT 419		381 825 023	
246 PPL 206		303 223 103		312 KI2 421		320 AI2 225*		350 TI2 223		371 KDA 119*		381 830 023	D71
246 PPL 207		303 223 203		312 KI2 123		320 AI2 325*		350 TI2 323		371 KDA 219*		381 835 023	
246 PPL 208		304 021 102		312 KI2 223		320 AI2 425*		350 TI2 423		371 KDA 319*		381 840 023	
246 FPL 207		304 021 202		312 KI2 323	D58	325 CMK 221		350 ATT 123*	D57	371 KDA 419*		381 845 023	
246 TBL 204		304 021 302		312 KI2 423		325 CMK 321		350 ATT 223*		371 KDT 121		381 825 025	
246 TBL 205		304 021 402		312 KI2 125		325 CMK 421		350 ATT 223*		371 KDT 221		381 830 025	
246 TBL 206	B33	304 023 102	D55	312 KI2 225		325 CMK 123		350 ATT 323*		371 KDT 321		381 835 025	
246 TBL 207		304 023 202		312 KI2 325		325 CMK 223		350 ATT 423*		371 KDT 421		381 840 025	
246 TBL 208		304 023 302		312 KI2 425		325 CMK 323		350 TI2 125		371 KDA 121*		381 845 025	
246 OFL 204		304 023 402		315 CMT 119		325 CMK 423		350 TI2 225		371 KDA 221*		381 D60 Z12	
246 OFL 205		304 025 102		315 CMT 219		325 CMK 125	D61	350 TI2 325		371 KDA 321*	D65	381 D40 Z12	
246 OFL 206	B35	304 025 202		315 CMT 319		325 CMK 225		350 TI2 425		371 KDA 421*	D65	381 D40 Z15	D32
246 KFL 206		304 025 302		315 CMT 419		325 CMK 325		350 ATT 125*		371 KDT 123		381 D60 Z15	D32
250 036 000		304 025 402		315 CMT 121		325 CMK 119		350 ATT 225*		371 KDT 223		381 D40 Z18	
250 049 000	B43	310 T25 008		315 CMT 221		325 CMK 219		350 ATT 325*		371 KDT 323		381 D60 Z18	
252 000 010		310 T30 008		315 CMT 321		325 CMK 319		350 ATT 425*		371 KDT 423		382 KDT 119	
252 000 020		310 A25 008		315 CMT 421		325 CMK 419		360 TIO 223		371 KDA 123*		382 KDT 219	
252 610 PA6		310 A30 008		315 CMT 123	D68	325 CMK 121		360 TIO 323		371 KDA 223*		382 KDT 319	
252 620 PA6		310 T25 010		315 CMT 223		325 CMK 425		360 TIO 423		371 KDA 323*		382 KDT 419	
252 611 PA6	B13	310 T30 010	D68	315 CMT 323		326 KI2 121		360 TIA 123*		371 KDA 423*		382 KDT 121	
252 621 PA6		310 A25 010		315 CMT 423		326 KI2 221		360 TIA 223*		371 KDT 125		382 KDT 221	
252 710 PA6		310 A30 010		315 CMT 125		326 KI2 321		360 TIA 323*		371 KDT 225		382 KDT 321	
252 810 PA6		310 T25 012		315 CMT 225		326 KI2 421		360 TIA 423*		371 KDT 325		382 KDT 421	D66
252 711 PA6		310 T30 012		315 CMT 325		326 KI2 123		360 TIO 125		371 KDT 425		382 KDT 123	
252 811 PA6		310 A25 012		315 CMT 425		326 KI2 223	D67	360 TIO 225		371 KDA 125*		382 KDT 223	
261 908 517		310 A30 012		318 T25 010	D70	326 KI2 323		360 TIO 325		371 KDA 225*		382 KDT 323	
261 302 015		310 KI1 M17		318 T30 010		326 KI2 423		360 TIO 425		371 KDA 325*		382 KDT 423	
261 HPL 015		310 KI1 M19		320 TI1 117		326 KI2 125		360 TIA 125*		371 KDA 425*		382 KDT 125	
261 353 126		310 KI1 M21	D70	320 TI1 217		326 KI2 225		360 TIA 225*		374 KDS 082	D57	382 KDT 225	
261 484 319		310 KI1 M23		320 TI1 119		326 KI2 325		360 TIA 325*		374 KDS 114	D57	382 KDT 325	
261 484 322		310 KI1 M25		320 TI1 219		326 KI2 425		360 TIA 425*		380 825 021		382 KDT 425	
261 484 326	B29	311 KI2 421		320 TI1 121	D58	328 KI1 117		360 TIO 017		380 830 021		382 D40 Z16	D48
261 484 320*		311 KI2 123		320 TI1 221		328 KI1 217		360 TIO 117		380 835 021		382 D60 Z16	
261 504 532		311 KI2 223		320 TI1 123		328 KI1 119		360 TIO 217		380 840 021		383 A25 T10	
261 605 542		311 KI2 323		320 TI1 223		328 KI1 219	D60	360 TIO 317	D69	380 845 021		383 A30 T10	
261 605 547		311 KI2 423		320 TI1 125		328 KI1 121		360 TIO 417		380 825 023		383 T25 A12	
261 756 647		311 KI2 125	D59	320 TI1 225		328 KI1 221		360 TIA 017*		380 830 023		383 T30 A12	D61
261 757 047		311 KI2 225		320 TI2 119		328 KI1 123		360 TIA 117*		380 835 023	D71	385 H25 T10	
261 757 035		311 KI2 325		320 TI2 219		328 KI1 223		360 TIA 217*		380 840 023		385 H25 T12	
261 9TD 517	B43	311 KI2 425		320 TI2 119*		329 KI1 117		360 TIA 317*		380 845 023		385 H30 A10	
261 504 532		311 KI2 121		320 TI2 219*		329 KI1 219	D67	360 TIA 417*		380 825 025		385 H30 A12	
271 434 016		311 KI2 221		320 TI2 121		329 KI1 217		360 TIO 119		380 830 025	D75	386 KDT 109	
271 504 514		311 KI2 321		320 TI2 221		329 KI1 119		360 TIO 219		380 835 025		386 KDT 209	
271 434 014		312 TI1 117		320 TI2 321		338 T25 010	D70	360 TIO 319		380 840 025		386 KDT 309	
271 524 014		312 TI1 217		320 TI2 421		340 TI1 117		360 TIO 419		380 845 025		386 KDT 409	
271 524 016	B29	312 TI1 119		320 AI2 121*		340 TI1 117		360 TIA 119*		380 ABD 216	D75	386 KDA 109*	
271 524 018		312 TI1 219		320 AI2 221*	D60	340 TI1 217		360 TIA 219*		380 ABT 200	D75	386 KDA 209*	
271 524 020		312 TI1 121		320 AI2 321*		340 TI1 119		360 TIA 319*		380 G40 Z08		386 KDA 309*	
271 524 316		312 TI1 221		320 AI2 421*		340 TI1 219		360 TIA 419*		380 G60 Z08		386 KDA 409*	D63
271 524 320		312 TI1 321	D56	320 TI2 123		340 TI1 121	D59	360 TIO 121		380 G40 Z12	D44	386 KDT 110	
300 İTİ 119		312 TI1 421		320 TI2 223		340 TI1 221		360 TIO 221		380 G60 Z12		386 KDT 210	
300 İTİ 219		312 TI1 123		320 TI2 323		340 TI1 123		360 TIO 321		380 G40 Z16		386 KDT 310	
300 İTİ 121	D54	312 TI1 223		320 TI2 423		340 TI1 223		360 TIO 421		380 G60 Z16		386 KDT 410	
300 İTİ 212		312 TI1 323		320 AI2 123*		340 TI1 125		360 TIA 121*		380 AKT A08		386 KDA 110*	
300 İTİ 123		312 TI1 423		320 AI2 223*		340 TI1 225		360 TIA 221*		380 AKT A10	D22	386 KDA 210*	
300 İTİ 223		312 TI1 125		320 AI2 323*		350 TI2 121	D57	360 TIA 321*		380 AKT A12		386 KDA 310*	

KOD/CODE	SAYFA PAGE	KOD/CODE	SAYFA PAGE	KOD/CODE	SAYFA PAGE	KOD/CODE	SAYFA PAGE	KOD/CODE	SAYFA PAGE	KOD/CODE	SAYFA PAGE		
386 KDA 410*		392 KDT 111		501 601 615		505 112 029	A7	510 601 210		560 121 615		700 640 147	
386 KDT 111		392 KDT 211		501 601 621		505 121 610		510 601 215		560 121 621		700 640 148	B26
386 KDT 211		392 KDT 311		501 602 010	A6	505 121 615		510 601 408		560 121 629		700 640 060	
386 KDT 311		392 KDT 411	D66	501 602 015		505 121 621		510 601 410		560 122 010		700 640 501	
386 KDT 411		392 KDT 112		501 602 021		505 121 631		510 601 415		560 122 015		753 050 030	B43
386 KDA 111*		392 KDT 212		501 801 610		505 121 631		510 601 610		560 122 021	A10	758 000 036	B43
386 KDA 211*		392 KDT 312		501 801 615		505 122 015	A8	510 601 615		560 122 029		765 020 020	
386 KDA 311*		392 KDT 412		501 801 621		505 122 010		510 601 620		560 122 415		765 020 021	
386 KDA 411*	D63	395 CMA 425*		501 802 010		505 122 029		510 602 010		560 122 421		765 025 025	C1
386 KDT 112		395 CM2 119		501 802 015		505 122 415		510 602 015		560 122 429		765 025 026	
386 KDT 212		395 CM2 219		501 802 021		505 122 421		510 602 020		560 123 021		765 030 030	
386 KDT 312		395 CM2 319		501 111 610	A7	505 122 429		510 800 880		560 000 050		765 030 031	
386 KDT 412		395 CM2 419		501 111 615		507 501 610		510 801 080		560 000 060		765 040 040	
386 KDA 112*		395 CMA 119*		501 111 621		507 501 615		510 801 010		560 000 080		765 040 041	
386 KDA 212*		395 CMA 219*		501 111 629		507 501 621		510 801 880	A1	560 000 100		765 045 047	C2
386 KDA 312*		395 CMA 319*		501 112 010		507 601 610		510 801 210		560 000 120	A12	765 045 048	C2
386 KDA 412*		395 CMA 419*		501 112 015		507 601 615		510 801 215		570 000 080		765 045 045	
387 KDT 109		395 CM2 121		501 112 021		507 601 621		510 801 408		570 000 100		765 045 046	
387 KDT 209		395 CM2 221		501 112 031		507 602 010		510 801 410		570 000 120		765 050 050	
387 KDT 309		395 CM2 321		501 121 610		507 602 015		510 801 415		570 000 150		765 050 051	
387 KDT 409		395 CM2 421		501 121 615		507 602 021		510 801 610		580 801 610		765 025 150	C3
387 KDA 109*		395 CMA 121*	D62	501 121 621		507 801 610		510 801 615		580 801 615		765 025 151	
387 KDA 209*		395 CMA 221*		501 121 631		507 801 615		510 801 620		580 801 621		765 085 075	
387 KDA 309*		395 CMA 321*		501 122 010	A8	507 801 621		510 802 010		580 101 610		765 085 076	
387 KDA 409*		395 CMA 421*		501 122 015		507 802 010		510 802 015		580 101 615		765 023 129	
387 KDT 110		395 CM2 123		501 122 029		507 802 015		510 802 020		580 101 621		765 023 130	
387 KDT 210		395 CM2 223		501 122 415		507 802 021		510 802 415		580 102 010		765 025 105	C6
387 KDT 310		395 CM2 323		501 122 421		507 101 610	A9	510 802 420		580 102 015		765 025 106	
387 KDT 410		395 CM2 423		501 122 429		507 101 615		510 600 000	A2	580 121 610		765 025 115	
387 KDA 110*		395 CMA 123*		502 121 615		507 101 621		510 800 000		580 121 615		765 025 116	
387 KDA 210*		395 CMA 223*		502 121 621		507 102 010		510 101 000		580 121 621		765 050 088	
387 KDA 310*		395 CMA 323*		502 122 015		507 102 015		530 121 615		580 122 015		765 050 089	
387 KDA 410*		395 CMA 423*		502 122 021	A3	507 102 021		530 121 621		580 122 021		765 025 117	
387 KDT 111	D64	395 CM2 125		502 122 029		507 102 029		530 122 015		580 122 415		765 025 118	C7
387 KDT 211		395 CM2 225		502 122 415		507 102 415		530 122 021	A3	580 122 421		766 011 004	
387 KDT 311		395 CM2 325		502 122 421		507 102 421		530 122 029		590 801 610		766 011 005	
387 KDT 411		395 CM2 425		502 122 431		507 102 429		530 122 415		590 801 615	A11	766 011 006	
387 KDA 111*		395 CMA 125*		505 400 880		507 121 610		530 122 415		590 801 621		766 013 070	
387 KDA 211*		395 CMA 225*		505 401 070		507 121 615		530 122 431		590 101 610		766 013 111	C8
387 KDA 311*		395 CMA 325*		505 401 010	A4	507 121 621		560 501 610		590 101 615		766 013 145	
387 KDA 411*		400 400 855		505 401 270		507 121 629		560 501 615		590 101 621		766 013 112	
387 KDT 112		400 500 855	A5	505 401 210		507 122 010		560 501 621		590 102 010		766 011 010	
387 KDT 212		400 501 055		505 401 215		507 122 015		560 601 610		590 102 015		766 012 012	
387 KDT 312		500 000 040		505 601 610		507 122 021		560 601 615		590 121 015		766 012 014	C9
387 KDT 412		500 000 060		505 601 615		507 122 029		560 601 621		590 121 610		766 011 011	
387 KDA 112*		500 000 080	A2	505 601 621	A6	507 122 415		560 602 010		590 121 615		766 011 013	
387 KDA 212*		500 000 110		505 602 010		507 122 421		560 602 015		590 121 621		766 011 015	
387 KDA 312*		500 000 120		505 602 015		507 122 429		560 602 021		590 122 015		766 011 001	
387 KDA 412*		500 001 120		505 602 021		507 123 021		560 802 010		590 122 021		766 011 002	
388 T15 Z06		501 400 880		505 801 610		507 000 050		560 802 015	A10	590 122 415		766 015 001	
388 K15 Z08		501 401 070		505 801 615		507 000 060		560 802 021		590 122 421		766 015 002	
388 T15 Z24	D27	501 401 010		505 801 621		507 000 080		560 101 610		689 000 101	B16	766 015 003	
388 T15 Z28		501 401 270		505 802 010		507 000 100		560 101 615		700 ALU 025		766 015 004	
388 K15 Z05		501 401 210		505 802 015		507 000 120	A12	560 101 621		700 PAS 025		766 015 005	C10
392 KDT 109		501 401 215	A4	505 802 021		508 000 080		560 102 010		700 640 301	B25	766 015 006	
392 KDT 209		501 401 610		505 111 610		508 000 100		560 102 015		700 640 312		766 015 007	
392 KDT 309		501 401 615		505 111 615		508 000 120		560 102 021		700 640 313		766 015 008	
392 KDT 409	D66	501 401 621		505 111 621		508 000 150		560 102 029		700 460 110		766 010 012	
392 KDT 110		501 401 610		505 111 629	A7	510 600 880		560 102 415		700 640 149		766 010 013	
392 KDT 210		501 401 615		505 112 010		510 601 880		560 102 421		700 640 152	B26	766 010 014	
392 KDT 310		501 401 621		505 112 015		510 601 010	A1	560 102 429		700 640 154		766 018 002	
392 KDT 410		501 601 610	A6	505 112 021		510 601 880		560 121 610		700 640 146		766 018 001	C11

KOD/CODE	SAYFA PAGE	KOD/CODE	SAYFA PAGE	KOD/CODE	SAYFA PAGE	KOD/CODE	SAYFA PAGE	KOD/CODE	SAYFA PAGE	KOD/CODE	SAYFA PAGE		
766 018 003		800 413 881		820 GPA 0101		830 X03 K10		830 G01 K04*		843 B02 K06**	D40	865 SOO 058	D23
766 018 004	C11	800 411 660		820 GPA 114		830 X03 K12		830 G01 K06*		843 B01 K06**		868 G01 038	
766 018 007		800 412 797		820 GPA 152	B24	830 X03 K14		831 X03 K06*	D42	843 G00 082		868 G02 038	
766 018 008	C12	800 413 883	B24	820 GPA 190		830 X03 K16		831 X02 K06*		843 K00 034		868 G03 038	D41
766 018 009		800 411 100		820 K00 082		830 X03 K18		831 X01 K06*		843 K00 050		870 G01 038	
766 019 009		800 411 200		820 K00 088		830 X03 K20		832 G03 K06*		843 K00 082		870 G02 038	
766 019 010	C13	800 411 300		820 K00 101	B25	830 X03 K22		832 G02 K06*		843 B00 034	D17	870 G03 038	
766 019 011		800 BTE PA6		820 K00 114		830 X03 K24		832 M03 K06*		843 B00 050		870 BOO 058	D24
766 016 001		800 100 016	B25	820 K00 152		830 X03 K26		832 G01 K06*		843 B00 082		870 SOO 058	
766 016 011		800 167 077		820 K00 190	D73	830 X03 K28		832 M02 K06*	D39	843 S00 034		871 K00 030	D16
766 016 002	C14	800 167 078	D73	820 KPA 082		830 X03 K30		832 M01 K06*		843 S00 050		871 S00 030	
766 016 012		800 167 070		820 KPA 088		830 X03 K32		832 B03 K06*		843 S00 082		875 BOO 058	
766 016 003		800 167 071		820 KPA 101	D74	830 X03 K34		832 B02 K06*		845 B03 K02**		875 SOO 058	D24
766 016 013		800 167 071	D74	820 KPA 114		830 X03 K36		832 B01 K06*		845 B03 K04**		875 SOO 058	
766 014 020		800 167 073		820 KPA 152		830 X03 K38		833 G03 K06*		845 B03 K06**		880 TKT 082	
766 014 025		805 OHI 190		820 KPA 190	D5	830 X03 K40		833 G02 K06*		845 M02 K02*		880 TKT 114	
766 014 030		805 HRC 190		820 S00 082		830 X03 K42		833 G01 K06*		845 M02 K04**	D43	880 TBT 082	
766 014 040	C15	805 304 190	D5	820 S00 088		830 X03 K44		833 M03 K06*		845 M02 K04**		880 TBT 114	
766 014 045		805 430 190		820 S00 101	D4	830 X03 K46		833 M02 K06*	D40	845 G01 K02**		880 TPG 082	
766 014 050		808 RUL 038		820 S00 114		830 X03 K48		833 M01 K06*		845 G01 K04**		880 TPG 114	D14
766 014 590		808 RUL 050	D4	820 S00 152		830 X03 K50	D50	833 B03 K06*		845 G001 K06**		880 TPS 082	
766 211 010		810 304 031		820 S00 190		830 X03 K52		833 B02 K06*		850 B02 152		880 TPS 114	
766 111 008		810 304 044		820 SPA 082		830 X03 K54		833 B01 K06*		850 B01 152	D40	880 TPK 082	
766 311 010	C16	810 304 050		820 SPA 088	D3	830 X03 K56		835 B03 K02**		850 B01 152		880 TPK 114	
766 011 015		810 430 031		820 SPA 101		830 X03 K58		835 B03 K04**		850 B02 152		880 TPB 082	
766 011 016		810 430 044	D3	820 SPA 114		830 X03 K60		835 B03 K06**		854 S00 PA6	D17	880 TPB 114	
766 RUT 008		810 430 050		820 SPA 152		830 X03 K62		835 M02 K02**		854 G00 M0S	D18	880 TGO 082	
766 RUT 010		810 OHI 031		820 SPA 190		830 X03 K64		835 M02 K04**		855 B03 153		880 TGO 114	
766 RUT 012	C17	810 OHI 044		820 YPP 082	D4	830 X03 K66		835 M02 K06**	D42	855 B02 153	D18	880 TSO 082	
766 SBP 001		810 OHI 050		820 YPP 088		830 X03 K68		835 G01 K02**		855 B01 153		880 TSO 114	D15
766 011 003		815 OHI G82	D4	820 YPP 114		830 X03 K70		835 G01 K04**		855 G01 153		880 TKO 082	
766 011 004		815 304 082		820 316 082		830 X03 K72		835 G01 506**		855 G02 153		880 TKO 114	
767 000 004		815 304 088		820 316 088		830 X03 K74		840 B03 K02*		855 G03 153	D41	880 TBO 082	
767 000 005	B16	815 304 101		820 316 114		830 X03 K76		840 B03 K04*		855 M02 153		880 TBO 114	
767 000 006		815 304 114		821 GPA 088		830 X03 K78		840 B03 K06*		855 M03 153		880 TBP 082	
800 210 130F		815 304 152		821 B00 190	D3	830 X03 K80		840 M02 K02*		855 M01 153		880 TBO 082	D20
800 240 131F	B3	815 304 190	D3	821 B00 254		830 X03 K82		840 M02 K04*	D43	860 M03 153		880 KBO 082	
800 140 132F		815 430 082		821 B00 304		830 X03 K84		840 M02 K04*		860 M02 153		880 KBO 104	
800 120 101		815 430 088		821 G00 190		830 X03 K86		840 G01 K02*		860 BOO 058	D23	880 TGT 082	
800 120 102	B12	815 430 101		821 G00 254		830 X03 K88		840 G01 K04*		860 SOO 058		880 TGT 114	D14
800 120 103		815 430 114		821 G00 304		830 X03 K90		840 G01 K06*		860 G03 153		880 TST 082	
800 120 085		815 430 152		821 K00 190		830 X03 K92		841 X01 K06**		860 G02 153		880 TST 114	
800 235 350		815 430 190		821 K00 254		830 X03 K94		841 X03 K06**	D42	860 G01 153		881 OHI M08	
800 235 351		820 B00 082		821 K00 304		830 X03 K96		841 X02 K06**		860 M01 153	D41	881 OHI M11	D5
800 235 352		820 B00 088		821 S00 190		830 X03 K98		842 G03 K06**		860 B03 153		881 OHI M19	
800 235 353	B21	820 B00 101		821 S00 254		830 D01 G01		842 G02 K06**		860 B02 153		881 304 T08	
800 235 354		820 B00 114		821 S00 304		830 D03 M01		842 G01 K06**		860 B01 153		881 304 T11	
800 235 040		820 B00 152		821 BPM 190		830 D04 Y01	D75	842 M03 K06**		863 G00 114		881 304 T19	
800 235 060		820 B00 190		821 BPM 254		830 D02 B01		842 M02 K06**	D39	863 G00 152		881 OHI T08	
800 M20 001		820 BPA 082		821 BPM 304		830 D05 K01		842 M01 K06**		863 G00 190		881 OHI T11	
800 M15 001		820 BPA 088		822 G03 082		830 E01 G01		842 B03 K06**		863 K00 114	D18	881 OHI T19	D6
800 010 035	B22	820 BPA 101		822 G01 082	D11	830 E03 M01		842 B02 K06**		863 K00 152		881 304 008	
800 185 165		820 BPA 114	D11	822 G03 114		830 E04 Y01	D76	842 B01 K06**		863 K00 190		881 304 011	
800 711 014		820 BPA 152		822 G01 114		830 E02 B01		843 G00 034		863 B00 114		881 304 019	
800 411 652		820 BPA 190		822 G03 152		830 E05 K01		843 G00 050	D17	863 GKO 114	D21	881 OHI 008	
800 412 790		820 G00 082		822 G01 152		830 B03 K02*		843 G03 K06**		863 SKO 114		881 OHI 011	
800 413 877		820 G00 088		822 G01 190		830 B03 K04*		843 G02 K06**		863 B00 152		881 OHI 019	
800 411 654	B23	820 G00 101		822 G01 190		830 B03 K06*		843 G01 K06**		863 B00 190		882 TBK 190	
800 412 792		820 G00 114		830 X03 K02		830 M02 K02*	D42	843 M03 K06**	D40	863 S00 114	D18	882 TBG 190	D16
800 413 879		820 G00 152		830 X03 K04		830 M02 K04*		843 M02 K06**		863 S00 152		882 TBK 254	
800 411 657		820 G00 190		830 X03 K06		830 M02 K06*		843 M01 K06**		863 S00 190		882 TBG 254	
800 412 795	B24	820 GPA 082		830 X03 K08	D50	830 G01 K02*		843 B03 K06**		865 BOO 058	D23	882 BPT 114	D13

KOD/CODE	SAYFA PAGE	KOD/CODE	SAYFA PAGE	KOD/CODE	SAYFA PAGE	KOD/CODE	SAYFA PAGE	KOD/CODE	SAYFA PAGE
882 BPT 190		929 G03 K06*		944 B01 K36	D37	999 EK1 041		01THB50D	
882 BPT 254	D13	930 G03 K06**		945 G01 K06		999 EK1 053		01THB50E	
882 BPT 304		931 G04 K06*		946 G01 K06	D27	999 EK1 079	D72	01THB50F	
882 TBK 304		931 G01 K06*		945 G02 K06		999 EK1 114		01THB60D	
882 TBG 304	D16	932 G01 K06**	D29	946 G02 K06		999 EK1 123		01THB60E	B46
885 SKM 114	D20	931 G02 K06*		947 S01 K00	D36	SA4 015 R 40 01		01THB60F	
920 B01 K06	D33	932 G03 K06**		950 G01 K10*		SBO 025 R40 01		01THB60N	
922 B01 K06		931 G03 K06*		951 G01 K10**		SB1 025 R01		01THB60P	
921 B01 K06	D34	932 G03 K06**		950 G02 K10*		SB1 040 R01		01THB80E	
923 B01 K06		935 G01 K06*		951 G02 K10**		SB1 050 R01		01THB80N	
925 X01 K01		936 G01 K06**		950 G03 K10*		SB1.1 040 R01		01THB80P	
925 X01 K02	D52	935 G02 K06*		951 G03 K10**		SB1.1 060 R01		01THB80Q	
925 X01 K03		936 G02 K06**		963 G01 K10*	D45	SB2 040 R01		01PB2A	
925 X01 K04		935 G03 K06*		963 G01 K10**		SB1 065 R01	B44	01PB2B	
925 X01 K05		936 G03 K06**	D31	963 G02 K10*		SC1K 040 R01		01PB2C	
925 X01 K06		937 G01 K06*		963 G02 K10**		SC1K 060 R01		01PB3B	
925 X01 K07		938 G01 K06**		963 G03 K10*		SC1K 080 R01		01PB3BC	
925 X01 K08		937 G02 K06*		963 G03 K10**		SC1K YK 040 R01		01PB3BD	
925 X01 K09		938 G02 K06**		952 G01 K10*		SD0 080 R01		01PB3C	
925 X01 K10		937 G03 K06*		953 G01 K10**		SD0 090 R01		01PB3D	
925 X01 K11		937 G03 K06**		952 G02 K10*		SD0 0100 R01		01PB4C	
925 X01 K12		939 G04 T01		953 G02 K10**		SD0 0120 R01		01PB4D	
925 X01 K13		939 G01 T01		952 G03 K10*		SD0K 080 R01		01PB4E	
925 X01 K14		939 G02 T01		952 G03 K10**	D46	SD0K 090 R01		01PB4F	
925 X01 K15		939 G03 T01		954 G01 K10*		SD0K 0100 R01		01PB5C	
925 X01 K16		939 G04 T02		954 G02 K10*		SD0K 0120 R01		01PB5D	
925 X01 K17		939 G01 T02		954 G03 K10*		SS 815 TAB K325		01PB5E	B49
925 X01 K18	D52	939 G02 T02		955 G01 K10**		SS 815 TAB K450	D35	01PB5F	
925 X01 K19		939 G03 T02	D32	955 G02 K10**		SS 815 TAB K750		01PB6D	
925 X01 K20		939 G04 T03		955 G03 K10**		01412L		01PB6E	
925 X01 K21		939 G01 T03		956-957 G01 K06		01412M		01PB6F	
925 X01 K22		939 G02 T03		956-957 G01 K07		01VR10D		01PB7D	
925 X01 K23		939 G03 T03		956-957 G01 K08		01VR12E		01PB7E	
925 X01 K24		939 G04 T04		956-957 G01 K09	D48	01VR12M		01PB7F	
925 X01 K25		939 G01 T04		956-957 G01 K10		01VR15F		01PB7N	
925 X01 K26		939 G02 T04		956-957 G01 K11		01VR15M		01PB8E	
925 X01 K27		939 G03 T04		956-957 G01 K..		01VR15Q	B47	01PB8F	
925 X01 K28		944 B01 K38		958 B01 K02*		01VR17F		01PB8N	
925 X01 K29		944 B01 K39		958 B01 K04*	D47	01VR17M		01PB8P	
925 X01 K30		944 B01 K40		958 B01 K10*		01VR17Q		01PB9E	
925 X01 K31		944 B01 K08		960 G01 K02		01VR20F		01PB9F	
925 X01 K32		944 B01 K10		960 G01 K04		01VR20Q		01PB9N	
925 X01 K33		944 B01 K11		960 G01 K12		01VR20Q		01PB9P	
925 X01 K34		944 B01 K12		960 M02 K02		01THP20A10		01THPB30C10	
925 X01 K35		944 B01 K13		960 M02 K04	D44	01THP ...	B48	01THPB30C16	
925 X01 K36		944 B01 K14		960 M02 K12		01PF2B10		01THPB30C20	
925 X01 K37		944 B01 K16		960 B03 K02		01PF ...		01THPB30D10	
925 X01 K39		944 B01 K17		960 B03 K04		01THB20A		01THPB30D16	
925 X01 K40		944 B01 K18		960 B03 K12		01THB20B		01THPB30D20	
925 X01 K41		944 B01 K20		961 B01 K00		01THB20C		01THPB30D38	
925 X01 K..		944 B01 K21		961 B02 K00	D35	01THB25A		01200F1	
927 G04 K06*		944 B01 K22		962 B01 K00	D36	01THB25B		01200F2	
927 G01 K06*		944 B01 K23		999 EKO 020		01THB25C		01200F3	
928 G01 K06**		944 B01 K25		999 EKO 030		01THB25D		014420*	
927 G02 K06*		944 B01 K26		999 EKO 050		01THB30B	B46	01442S*	
928 G02 K06**		944 B01 K27		999 EKO 075		01THB30C		01452E	B45
927 G03 K06*	D29	944 B01 K29		999 EKO 110		01THB30D		1452F*	
928 G03 K06**		944 B01 K30	D37	999 EKO 119		01THN30E		01452G	
929 G01 06*		944 B01 K31		999 EKO 150		01THB40C		01452H*	
930 G01 K06**		944 B01 K33		999 EKO 199		01THB40D		01WM10D	
929 G02 K06*		944 B01 K34		999 EKO 336		01THB40E		01WM12E	B46
930 G02 K06**		944 B01 K35		999 EK1 024	D72	01THB50C		01WM12M	

A

**PABUÇLAR / BASES
SAPLAMALAR / SPINDLES
AYAKLAR / FEETS
PROFİL KILAVUZLARI
TUBE ENDS**

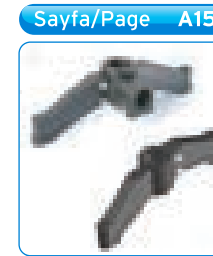
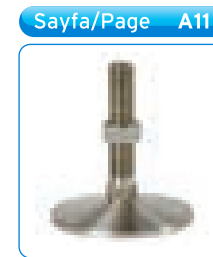
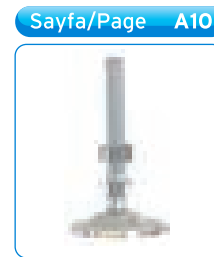
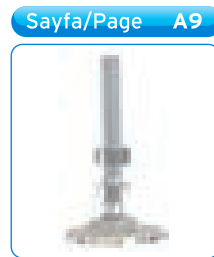
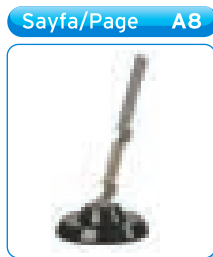
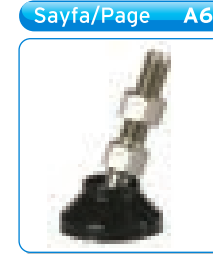
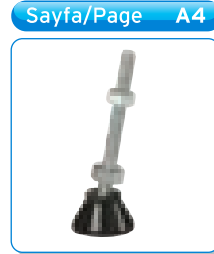
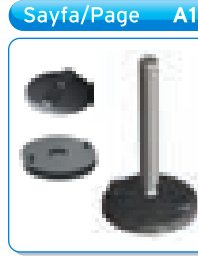
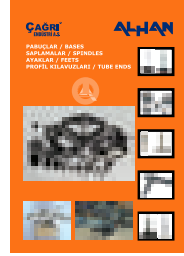

B



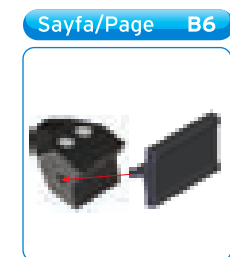
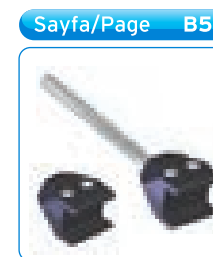
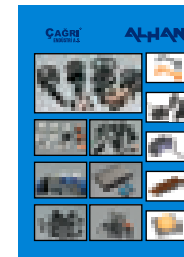
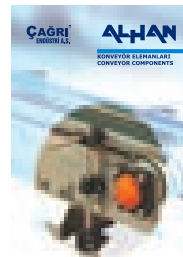







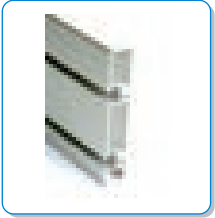
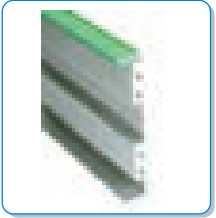
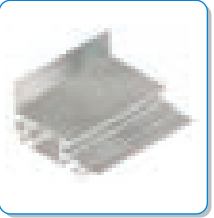
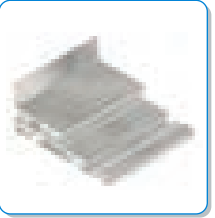
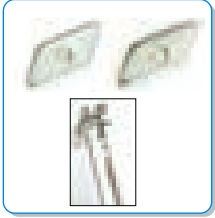



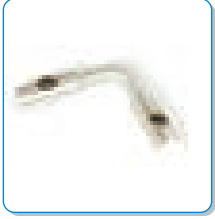



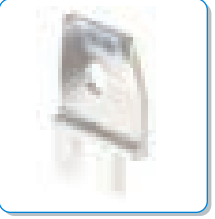
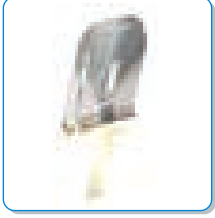

**KONVEYÖR ELEMANLARI
CONVEYOR COMPONENTS**

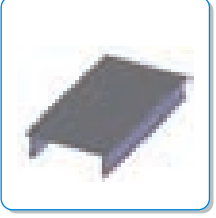
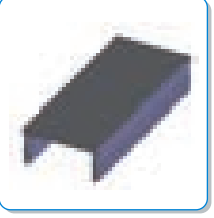
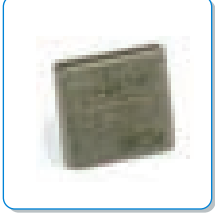
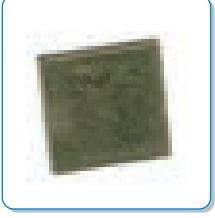
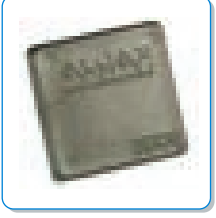

Sayfa/Page B6	Sayfa/Page B6	Sayfa/Page B7	Sayfa/Page B7	Sayfa/Page B8	Sayfa/Page B8
					
Sayfa/Page B9	Sayfa/Page B9	Sayfa/Page B9	Sayfa/Page B9	Sayfa/Page B10	Sayfa/Page B8
					
Sayfa/Page B10	Sayfa/Page B10	Sayfa/Page B11	Sayfa/Page B11	Sayfa/Page B11	Sayfa/Page B12
					
Sayfa/Page B12	Sayfa/Page B13	Sayfa/Page B13	Sayfa/Page B13	Sayfa/Page B13	Sayfa/Page B14
					
Sayfa/Page B14	Sayfa/Page B15	Sayfa/Page B15	Sayfa/Page B15	Sayfa/Page B16	Sayfa/Page B16
					
Sayfa/Page B16	Sayfa/Page B17	Sayfa/Page B17	Sayfa/Page B18	Sayfa/Page B18	Sayfa/Page B18
					
Sayfa/Page B19	Sayfa/Page B19	Sayfa/Page B19	Sayfa/Page B20	Sayfa/Page B20	Sayfa/Page B20
					

Sayfa/Page B21 	Sayfa/Page B21 	Sayfa/Page B21 	Sayfa/Page B22 	Sayfa/Page B22 	Sayfa/Page B22 
Sayfa/Page B22 	Sayfa/Page B23 	Sayfa/Page B23 	Sayfa/Page B24 	Sayfa/Page B24 	Sayfa/Page B24 
Sayfa/Page B25 	Sayfa/Page B25 	Sayfa/Page B25 	Sayfa/Page B26 	Sayfa/Page B26 	Sayfa/Page B26 
Sayfa/Page B26 	Sayfa/Page B27 	Sayfa/Page B27 	Sayfa/Page B27 	Sayfa/Page B27 	Sayfa/Page B28 
Sayfa/Page B28 	Sayfa/Page B28 	Sayfa/Page B29 	Sayfa/Page B29 	Sayfa/Page B29 	Sayfa/Page B30 
Sayfa/Page B30 	Sayfa/Page B31 	Sayfa/Page B31 	Sayfa/Page B32 	Sayfa/Page B32 	Sayfa/Page B33 
Sayfa/Page B33 	Sayfa/Page B34 	Sayfa/Page B34 	Sayfa/Page B35 	Sayfa/Page B35 	Sayfa/Page B35 

Sayfa/Page B36	Sayfa/Page B37	Sayfa/Page B38	Sayfa/Page B39	Sayfa/Page B40	Sayfa/Page B41
HAZIR RULO BAŞLIĞI BEARING FOR CONVEYOR ROLLERS	HAZIR RULO BAŞLIĞI BEARING FOR CONVEYOR ROLLERS	HAZIR RULO BAŞLIĞI BEARING FOR CONVEYOR ROLLERS	HAZIR RULO BAŞLIĞI BEARING FOR CONVEYOR ROLLERS	HAZIR RULO BAŞLIĞI BEARING FOR CONVEYOR ROLLERS	RULOLAR ROLLERS 
Sayfa/Page B42	Sayfa/Page B43	Sayfa/Page B43	Sayfa/Page B43	Sayfa/Page B44	Sayfa/Page B45
HELOZON ve YILDIZ ÖBEĞİ SCREW FEEDINGS COMPONENTS 					
Sayfa/Page B45	Sayfa/Page B46	Sayfa/Page B46	Sayfa/Page B47	Sayfa/Page B47	Sayfa/Page B48
					
Sayfa/Page B48	Sayfa/Page B48	Sayfa/Page B49	Sayfa/Page B49	Sayfa/Page B49	Sayfa/Page B49
					
C ALÜMİNYUM PROFİL VE ELEMANLARI ALUMINIUM PROFILES & COMPENENTS					Sayfa/Page C1 
Sayfa/Page C1	Sayfa/Page C1	Sayfa/Page C1	Sayfa/Page C2	Sayfa/Page C2	Sayfa/Page C3
					
Sayfa/Page C3	Sayfa/Page C3		Sayfa/Page C5	Sayfa/Page C5	Sayfa/Page C5
					

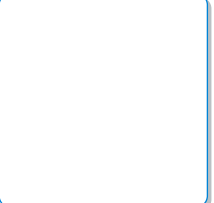
Sayfa/Page C6 	Sayfa/Page C6 	Sayfa/Page C6 	Sayfa/Page C6 	Sayfa/Page C7 	Sayfa/Page C7 
Sayfa/Page C7 	Sayfa/Page C8 	Sayfa/Page C8 	Sayfa/Page C8 	Sayfa/Page C8 	Sayfa/Page C9 
Sayfa/Page C9 	Sayfa/Page C9 	Sayfa/Page C10 	Sayfa/Page C10 	Sayfa/Page C11 	Sayfa/Page C11 
Sayfa/Page C11 	Sayfa/Page C11 	Sayfa/Page C12 	Sayfa/Page C12 	Sayfa/Page C12 	Sayfa/Page C13 
Sayfa/Page C13 	Sayfa/Page C13 	Sayfa/Page C14 	Sayfa/Page C14 	Sayfa/Page C14 	Sayfa/Page C14 
Sayfa/Page C15 	Sayfa/Page C15 	Sayfa/Page C15 	Sayfa/Page C15 	Sayfa/Page C16 	Sayfa/Page C16 
Sayfa/Page C16 	Sayfa/Page C17 	Sayfa/Page C17 	Sayfa/Page C17 	Sayfa/Page 	Sayfa/Page 

D

**BANTLAR / CHAIN BELTS
DİŞLİLER VE KASNAKLAR
SPROCKETS AND WHEELS**

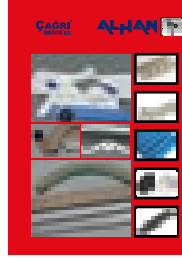

Sayfa/Page D1

**TERMOPLASTİK
MALZEMELER
TERMOPLASTICS
MATERIALS**

Sayfa/Page D2

**PASLANMAZ BANT
MALZEMELERİ VE
ÖZELLİKLERİ
STAINLES
STEEL CHAIN
PROPERTIES**

Sayfa/Page D3



Sayfa/Page D3

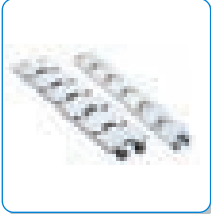

Sayfa/Page D4

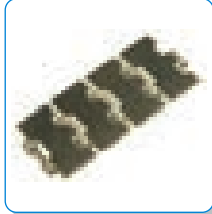

Sayfa/Page D4



Sayfa/Page D5



Sayfa/Page D5

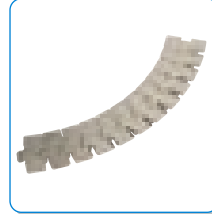

Sayfa/Page D6

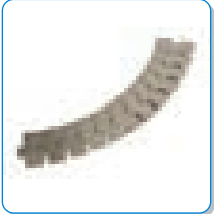

Sayfa/Page D6

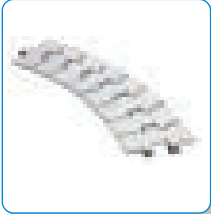

Sayfa/Page D7

**TEKNİK BİLGİ
TECHNICAL
INFORMATION**

Sayfa/Page D8

**TEKNİK BİLGİ
TECHNICAL
INFORMATION**

Sayfa/Page D9

**TEKNİK BİLGİ
TECHNICAL
INFORMATION**

Sayfa/Page D10

**TEKNİK BİLGİ
TECHNICAL
INFORMATION**

Sayfa/Page D11

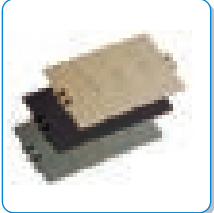

Sayfa/Page D12

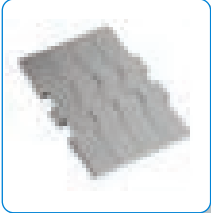

Sayfa/Page D13



Sayfa/Page D13



Sayfa/Page D14

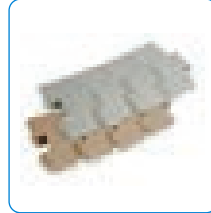

Sayfa/Page D14



Sayfa/Page D15

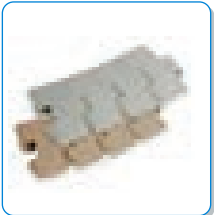

Sayfa/Page D16



Sayfa/Page D16



Sayfa/Page D17

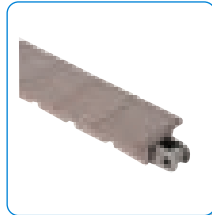

Sayfa/Page D17



Sayfa/Page D18



Sayfa/Page D19



Sayfa/Page D19

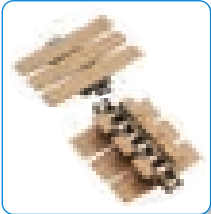

Sayfa/Page D20

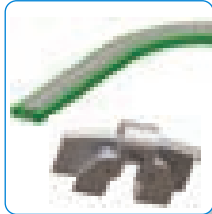

Sayfa/Page D20



Sayfa/Page D20



Sayfa/Page D21



Sayfa/Page D22

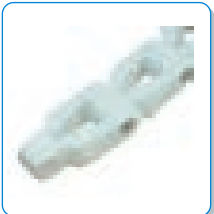

Sayfa/Page D22



Sayfa/Page D22

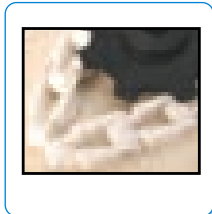

Sayfa/Page D23



Sayfa/Page D23







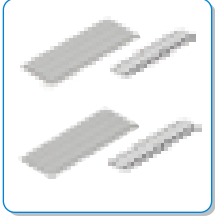



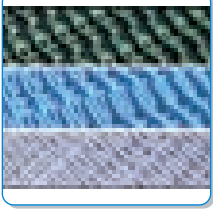
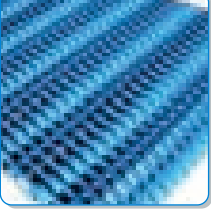

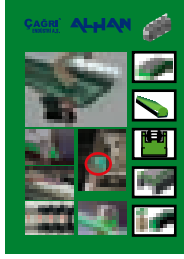
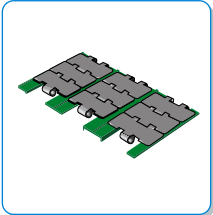

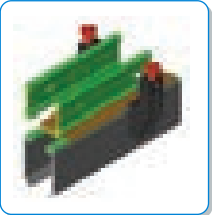

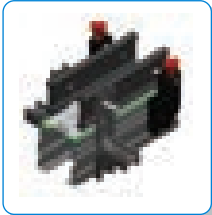
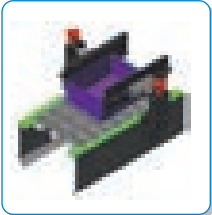
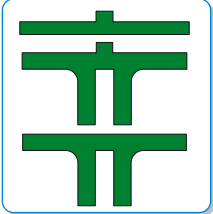
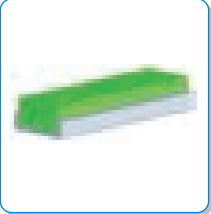

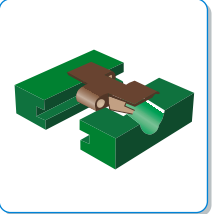
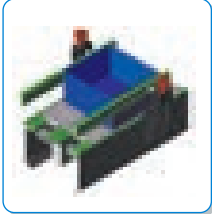
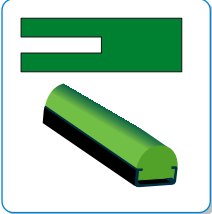

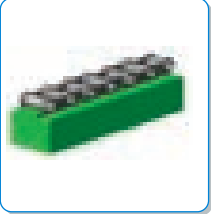

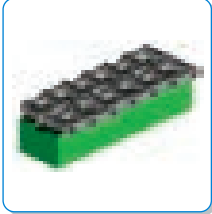
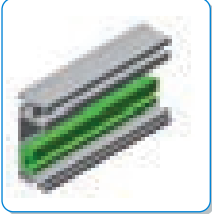
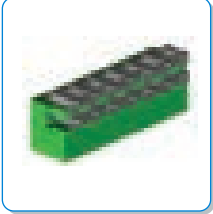
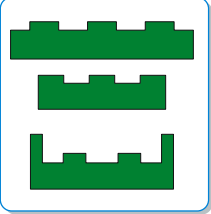
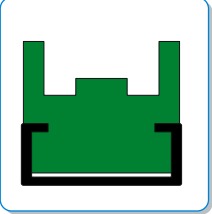
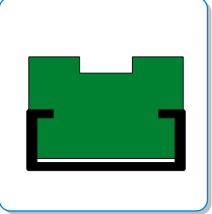
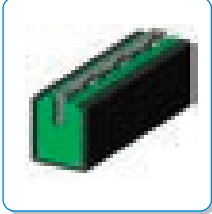
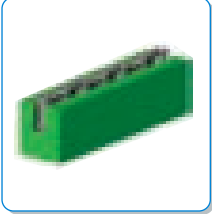

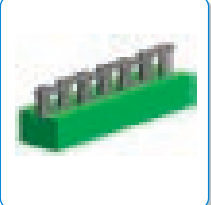
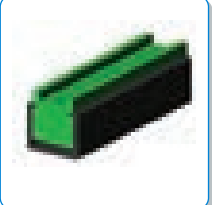

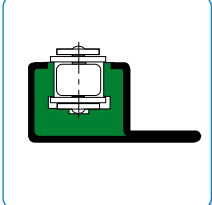
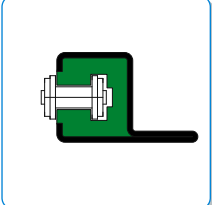

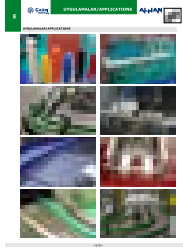
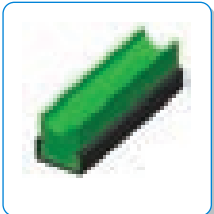
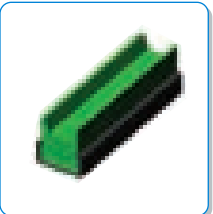
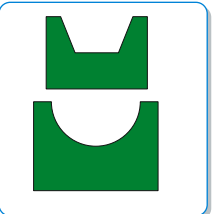
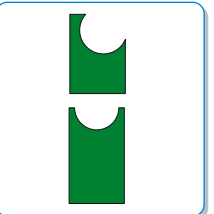
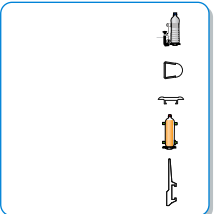

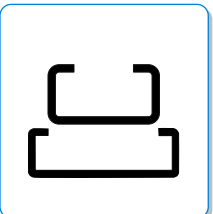

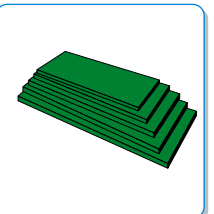
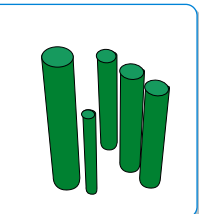
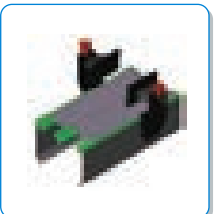
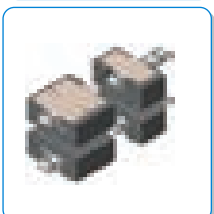
Sayfa/Page D24



Sayfa/Page D24 	Sayfa/Page D25 TEKNİK BİLGİ TECHNICAL INFORMATION	Sayfa/Page D26 TEKNİK BİLGİ TECHNICAL INFORMATION	Sayfa/Page D27 	Sayfa/Page D27 	
Sayfa/Page D29 	Sayfa/Page D29 		Sayfa/Page D31 	Sayfa/Page D31 	Sayfa/Page D32 
Sayfa/Page D32 	Sayfa/Page D33 	Sayfa/Page D33 	Sayfa/Page D34 	Sayfa/Page D34 	Sayfa/Page D35 
Sayfa/Page D35 	Sayfa/Page D36 	Sayfa/Page D36 	Sayfa/Page D37 		Sayfa/Page D39 
Sayfa/Page D40 	Sayfa/Page D40 	Sayfa/Page D41 	Sayfa/Page D41 	Sayfa/Page D42 	Sayfa/Page D42 
Sayfa/Page D43 	Sayfa/Page D43 	Sayfa/Page D44 	Sayfa/Page D44 	Sayfa/Page D45  Yeni New	Sayfa/Page D45 
Sayfa/Page D46 	Sayfa/Page D46 	Sayfa/Page D47 	Sayfa/Page D48  Yeni New	Sayfa/Page D48 	Sayfa/Page D49  Yeni New

Sayfa/Page D50	Sayfa/Page D51	Sayfa/Page D52	Sayfa/Page D53	Sayfa/Page D54	Sayfa/Page D54
HASIR BANTLAR MODULAR BELTS	KONVEYOR BANT İSTEK FORMU CONVEYOR BELT'S ORDER FORM	BANT GENİŞLİĞİ VE KODLAMA SİSTEMİ BELT WIDTH & CODE SYSTEM	BANT GENİŞLİĞİ VE KODLAMA SİSTEMİ BELT WIDTH & CODE SYSTEM		
Sayfa/Page D55	Sayfa/Page D55	Sayfa/Page D56	Sayfa/Page D56	Sayfa/Page D57	Sayfa/Page D57
					
Sayfa/Page D58	Sayfa/Page D58	Sayfa/Page D59	Sayfa/Page D59	Sayfa/Page D60	Sayfa/Page D60
					
Sayfa/Page D61	Sayfa/Page D61	Sayfa/Page D62	Sayfa/Page D63	Sayfa/Page D64	Sayfa/Page D65
					
Sayfa/Page D66	Sayfa/Page D66	Sayfa/Page D67	Sayfa/Page D67	Sayfa/Page D68	Sayfa/Page D68
					
Sayfa/Page D69	Sayfa/Page D70	Sayfa/Page D70	Sayfa/Page D70	Sayfa/Page D71	Sayfa/Page D71
					
Sayfa/Page D72	Sayfa/Page D73	Sayfa/Page D73	Sayfa/Page D73	Sayfa/Page D74	Sayfa/Page D74
					

Sayfa/Page D75 	Sayfa/Page D76 	Sayfa/Page D77 TEKNİK BİLGİ TECHNICAL INFORMATION	Sayfa/Page D78 STANDART MALZEMELER STANDARD MATERIALS	Sayfa/Page D79 STANDART MALZEMELER STANDARD MATERIALS	Sayfa/Page D80 STANDART MALZEMELER STANDARD MATERIALS
E SÜRTÜNME PROFİLLERİ ve ZİNCİR KIZAKLARI FRICTION GUIDES & ROLLER CHAIN GUIDES				Sayfa/Page E1 TEKNİK BİLGİ TECHNICAL INFORMATION	Sayfa/Page E2 TEKNİK BİLGİ TECHNICAL INFORMATION
Sayfa/Page E3 	Sayfa/Page E3 	Sayfa/Page E3 	Sayfa/Page E3 	Sayfa/Page E4 	Sayfa/Page E4 
Sayfa/Page E5 	Sayfa/Page E6 	Sayfa/Page E6 	Sayfa/Page E7 	Sayfa/Page E7 	Sayfa/Page E8 
Sayfa/Page E8 	Sayfa/Page E9 	Sayfa/Page E9 	Sayfa/Page E10 	Sayfa/Page E10 	Sayfa/Page E10 
Sayfa/Page E10 	Sayfa/Page E11 	Sayfa/Page E11 	Sayfa/Page E11 	Sayfa/Page E12 	Sayfa/Page E12 
Sayfa/Page E13 	Sayfa/Page E13 	Sayfa/Page E14 	Sayfa/Page E14 	Sayfa/Page E15 	Sayfa/Page E15 

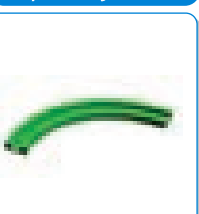
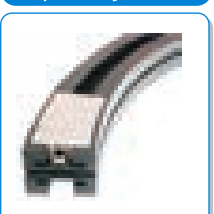
Sayfa/Page E16	Sayfa/Page E16	Sayfa/Page E17	Sayfa/Page E17		Sayfa/Page E19
					
Sayfa/Page E20	Sayfa/Page E22	Sayfa/Page E21	Sayfa/Page E22	Sayfa/Page E22	Sayfa/Page E22
					
Sayfa/Page E22	Sayfa/Page E13	Sayfa/Page E23	Sayfa/Page E23	Sayfa/Page E23	Sayfa/Page E24
					
Sayfa/Page E25	Sayfa/Page E26	Sayfa/Page E27	Sayfa/Page E27	Sayfa/Page E28	Sayfa/Page E28
					



PABUÇLAR / BASES
SAPLAMALAR / SPINDLES
AYAKLAR / FEET
PROFİL KILAVUZLARI / TUBE ENDS

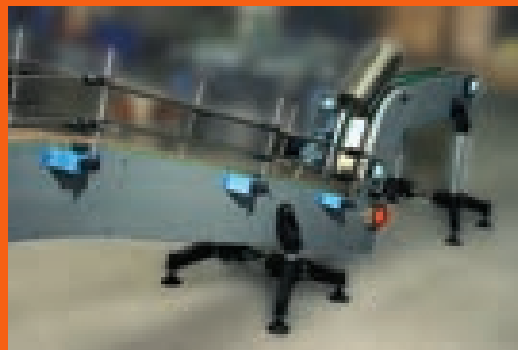
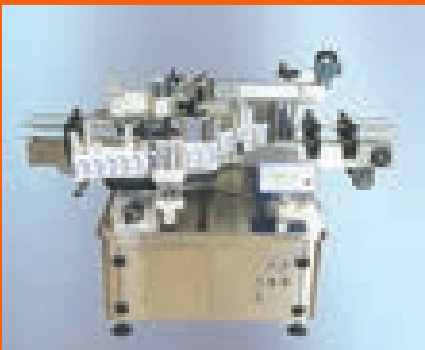
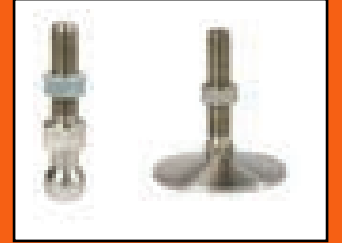



ÇAĞRI
ENDÜSTRİ A.Ş.

ALHAN

PABUÇLAR / BASES
SAPLAMALAR / SPINDLES
AYAKLAR / FEETS
PROFİL KILAVUZLARI / TUBE ENDS



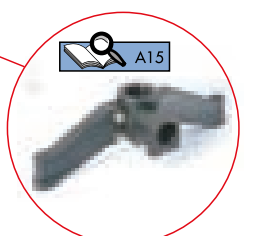
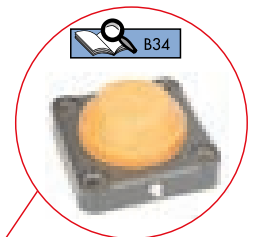

MODEL: 510 DÜZ TABAN PLASTİK PABUÇ (2 KÖŞELİ METAL ÇİNKO KAPLAMA)



ARTICULATED FEET

Taban/Base: Güçlendirilmiş Polyamid/Reinforced Polyamide **(PA)**

Saplama/Spindle: Çinko Kaplama Metal/Zinc Plated Steel **(ZN)**

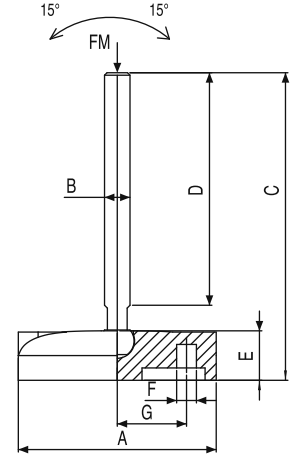
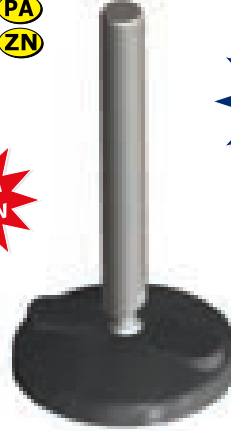
(HD) Hesaplı Dizi / Economic Series



(M)	A	B	C	D		Kg	STN Stok Kod Stock Code	AV Stok Kod Stock Code		FM N (Newton)	Tip Type
*	60	M8	82	45	5	0,080	510 600 880	510 600 880AV	50	12000	
	60	M10	82	45	7	0,090	510 601 080	510 601 080AV	50	12000	
	60	M10	112	75	7	0,100	510 601 010	510 601 010AV	50	12000	
	60	M12	82	45	9	0,110	510 601 880	510 601 880AV	50	12000	
	60	M12	112	75	9	0,120	510 601 210	510 601 210AV	50	12000	
	60	M12	162	125	9	0,168	510 601 215	510 601 215AV	50	14000	
	60	M14	82	45	11	0,112	510 601 408	510 601 408AV	50	14000	
	60	M14	108	75	11	0,137	510 601 410	510 601 410AV	50	14000	
	60	M14	158	125	11	0,203	510 601 415	510 601 415AV	50	14000	
	60	M16	108	75	13	0,150	510 601 610	510 601 610AV	50	15000	
	60	M16	158	125	13	0,215	510 601 615	510 601 615AV	50	15000	
	60	M16	208	180	13	0,279	510 601 620	510 601 620AV	50	15000	
	60	M20	108	75	16	0,175	510 602 010	510 602 010AV	50	16000	
	60	M20	158	125	16	0,250	510 602 015	510 602 015AV	50	16000	
	60	M20	208	180	16	0,325	510 602 020	510 602 020AV	50	16000	
(ZN)	80	M8	80	45	5	0,100	510 800 880	510 800 880AV	40	16000	
	80	M10	80	45	7	0,100	510 801 080	510 801 080AV	40	10000	
	80	M10	108	75	7	0,120	510 801 010	510 801 010AV	40	12000	
	80	M12	82	45	9	0,110	510 801 880	510 801 880AV	40	12000	
	80	M12	108	75	9	0,135	510 801 210	510 801 210AV	40	12000	
	80	M12	158	125	9	0,183	510 801 215	510 801 215AV	40	12000	
	80	M14	81	45	11	0,130	510 801 408	510 801 408AV	40	18000	
	80	M14	108	75	11	0,152	510 801 410	510 801 410AV	40	18000	
	80	M14	158	125	11	0,218	510 801 415	510 801 415AV	40	15000	
	80	M16	108	75	13	0,167	510 801 610	510 801 610AV	40	18000	
	80	M16	158	125	13	0,230	510 801 615	510 801 615AV	40	18000	
	80	M16	208	180	13	0,294	510 801 620	510 801 620AV	40	18000	
	80	M20	108	75	16	0,190	510 802 010	510 802 010AV	40	10000	
	80	M20	158	125	16	0,265	510 802 015	510 802 015AV	40	12000	
	80	M20	208	180	16	0,340	510 802 020	510 802 020AV	40	12000	
	80	M16	108	75	13	0,222	510 101 610	510 101 610AV	40	18000	
	100	M16	158	125	13	0,285	510 101 615	510 101 615AV	40	15000	
	100	M16	208	180	13	0,349	510 101 620	510 101 620AV	40	15000	
*	100	M20	108	75	16	0,245	510 102 010	510 102 010AV	40	19000	
*	100	M20	158	125	16	0,320	510 102 015	510 102 015AV	40	19000	
	100	M20	208	180	16	0,395	510 102 020	510 102 020AV	40	19000	
	100	M24	158	125	19	0,365	510 102 415	510 102 415AV	40	20000	
	100	M24	208	180	19	0,455	510 102 420	510 102 420AV	30	20000	

510 600 880 — 515 600 880

(ZN)

(SS)

*Özel üretim yapılır./On request special production is available.

MODEL: 510-515 PLASTİK PABUÇ TABANI

PLASTIC ARTICULATED BASE

Malzeme/Material: Güçlendirilmiş Polyamid/Reinforced Polyamide
(Renk/Colour: Siyah/Black)



Taban Çapı (Base Diameter)	Kg	STN Stok Kod Stock Code	AV Stok Kod Stock Code	A	
60	0,03	510 600 000	510 600 000AV	18	75
80	0,05	510 800 000	510 800 000AV	20.50	50
100	0,10	510 101 000	510 101 000AV	28	40

MODEL: 500 PLASTİK PABUÇ TABANI

PLASTIC ARTICULATED BASE

Malzeme/Material: Güçlendirilmiş Polyamid/Reinforced Polyamide **PA**
(Renk/Colour: Siyah/Black)

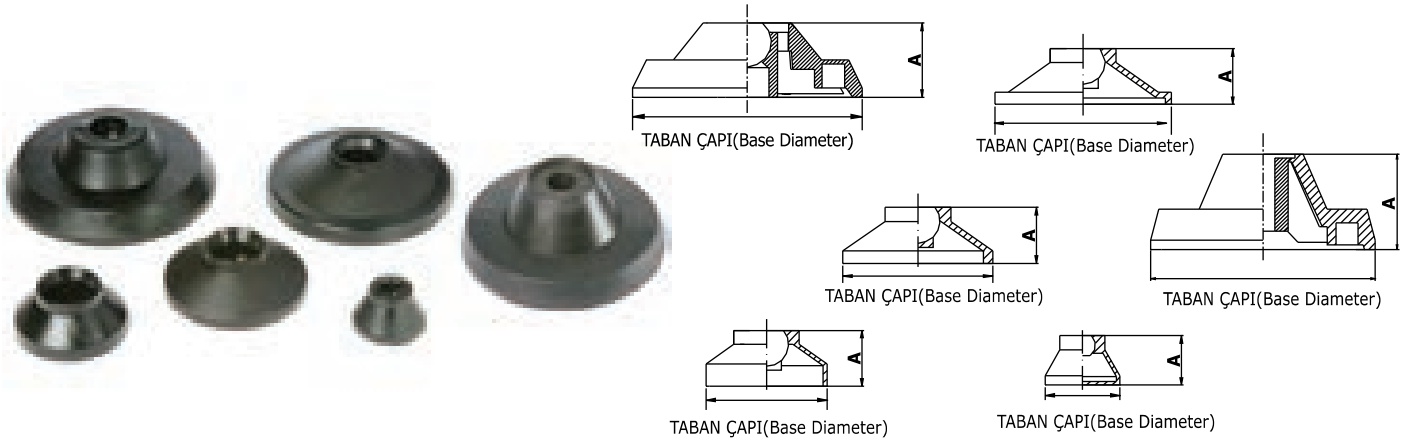

Taban Çapı (Base Diameter)	Kg	STN Stok Kod Stock Code	A	
40	0,014	500 000 040	24	100
60	0,026	500 000 060	28	75
80	0,032	500 000 080	28	50
110	0,077	500 000 110	30	40
120	0,155	500 000 120	40	30
120	0,170	500 001 120	50	30



UYARI 1-2/WARNING 1-2 → SAYFA C/PAGE C

*Özel üretim yapılır./On request special production is available.

MODEL: 502 ÇİNKO KAPLAMALI AĞIR TİP SABİT PABUÇLAR

HARD TYPE ARTICULATED FEET (WITH SNAP RING)

Taban/Base: Güçlendirilmiş Polyamid/Reinforced Polyamide (PA)

Saplama/Spindle: Çinko Kaplama Metal/Zinc Plated Steel (ZN)



C1

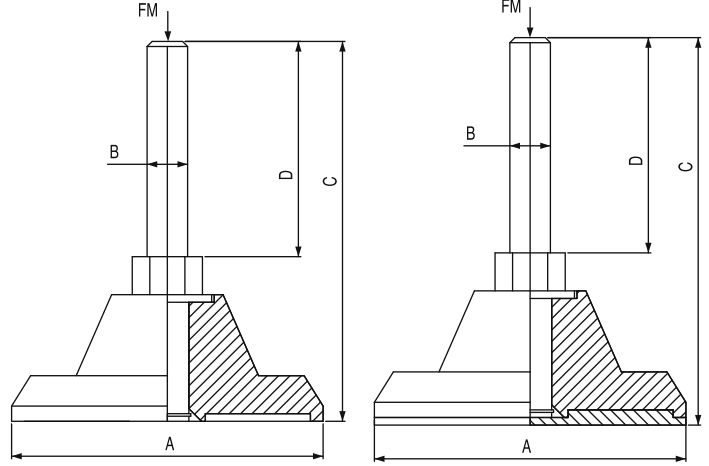

A	B	C	D		Kg	STN Stok Kod Stock Code		FM N (Newton)	Tip/Type
120	M16	174	95	24	0,460	502 121 615	15	35000	C1
120	M16	224	145	24	0,540	502 121 621	10		
120	M20	174	95	24	0,545	502 122 015	15		
120	M20	224	145	24	0,645	502 122 021	10		
120	M20	314	235	24	0,835	502 122 029	8		
120	M24	174	95	24	0,670	502 122 415	15		
120	M24	224	145	24	0,800	502 122 421	8		
120	M24	314	235	24	1,050	502 122 431	8		

MODEL: 530 AISI 304 (INOX) PASLANMAZ AĞIR TİP SABİT PABUÇLAR

HARD TYPE ARTICULATED FEET (WITH SNAP RING)

Taban/Base: Güçlendirilmiş Polyamid/Reinforced Polyamide (PA)

Saplama/Spindle: AISI 304 (Inox) Paslanmaz/AISI 304 Stainless Steel (SS)

A	B	C	D		Kg	STN Stok Kod Stock Code		FM N (Newton)	Tip/Type
120	M16	174	95	24	0,460	530 121 615	15	35000	C1
120	M16	224	145	24	0,540	530 121 621	10		
120	M20	174	95	24	0,545	530 122 015	15		
120	M20	224	145	24	0,645	530 122 021	10		
120	M20	314	235	24	0,835	530 122 029	8		
120	M24	174	95	24	0,670	530 122 415	15		
120	M24	224	145	24	0,800	530 122 421	8		
120	M24	314	235	24	1,050	530 122 431	8		



UYARI 1-2/WARNING 1-2→SAYFA C/PAGE C

*Özel üretim yapılır./On request special production is available.

MODEL: 501 PLASTİK PABUÇ (6 KÖŞESİ METAL ÇİNKO KAPLAMALI)

ARTICULATED FEET

Taban/Base: Güçlendirilmiş Polyamid/Reinforced Polyamide (PA)

Saplama/Spindle: Çinko Kaplama Metal/Zinc Plated Steel (ZN)

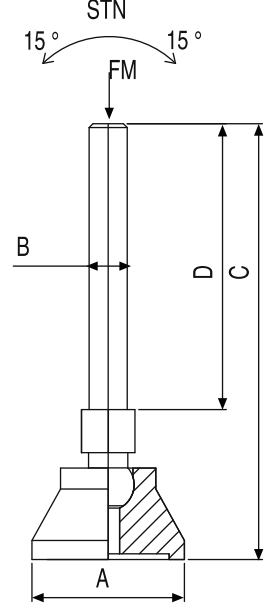

A	B	C	D		Kg	Stok Kod Stock Code		FM N (Newton)	Tip Type
40	M8	89	45	14	0,060	501 400 880	100	8000	D
40	M10	89	45	14	0,075	501 401 070	100	10000	
40	M10	119	75	14	0,085	501 401 010	100	10000	
40	M12	89	45	14	0,086	501 401 270	100	12000	
40	M12	119	75	14	0,109	501 401 210	100	12000	
40	M12	169	125	14	0,140	501 401 215	50	12000	
40	M16	119	75	17	0,173	501 401 610	50	12000	
40	M16	169	125	17	0,239	501 401 615	50	12000	
40	M16	219	175	17	0,318	501 401 621	50	12000	

MODEL: 505 PLASTİK PABUÇ (6 KÖŞESİ PASLANMAZ ÇELİK) AISI 304 (INOX)

ARTICULATED FEET

Taban/Base: Güçlendirilmiş Polyamid/Reinforced Polyamide (PA)

Saplama/Spindle: AISI 304 (Inox) Paslanmaz/AISI 304 Stainless Steel (SS)

A	B	C	D		Kg	Stok Kod Stock Code		FM N (Newton)	Tip Type
40	M8	89	45	14	0,060	505 400 880	100	8000	D
40	M10	89	45	14	0,075	505 401 070	100	10000	
40	M10	119	75	14	0,085	505 401 010	100	10000	
40	M12	89	45	14	0,086	505 401 270	100	12000	
40	M12	119	75	14	0,109	505 401 210	100	12000	
40	M12	169	125	14	0,140	505 401 215	50	12000	
40	M16	119	75	17	0,173	505 401 610	50	12000	
40	M16	169	125	17	0,239	505 401 615	50	12000	
40	M16	219	175	17	0,318	505 401 621	50	12000	



UYARI 1-2/WARNING 1-2 → SAYFA C/PAGE C

*Özel üretim yapılır./On request special production is available.

MODEL: 400 SABİT PLASTİK PABUÇ (METAL SAPLAMA)

PLASTIC FIXED FEET

Taban/Base: Güçlendirilmiş Polyamid/Reinforced Polyamide **PA**

Saplama/Spindle: Çinko Kaplama Metal/Zinc Plated Steel **ZN**

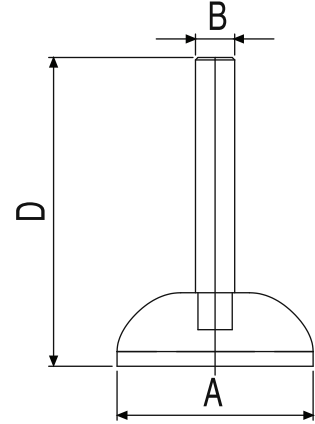

A	B	C	D	E	Kg	Stok Kod Stock Code		FM N (Newton)
40	M8	55	35	15	0,030	400 400 855	100	4000
50	M8	55	35	17	0,035	400 500 855	100	5000
50	M10	55	35	17	0,050	400 501 055	100	5000



UYARI 1-2/WARNING 1-2→SAYFA C/PAGE C

*Özel üretim yapılır./On request special production is available.

MODEL: 501 PLASTİK PABUÇ (6 KÖŞESİ METAL ÇİNKO KAPLAMALI)

ARTICULATED FEET

Taban/Base: Güçlendirilmiş Polyamid/Reinforced Polyamide **PA**

Saplama/Spindle: Çinko Kaplama Metal/Zinc Plated Steel **ZN**

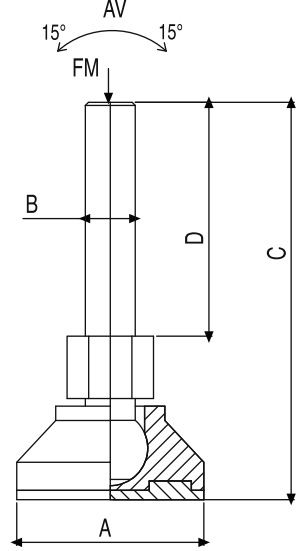
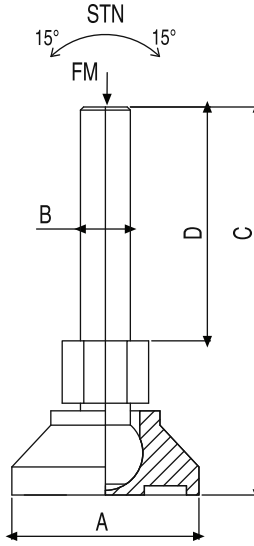

A	B	C	D		Kg	STN Stok Kod Stock Code		FM N (Newton)	Tip/Type
60	M16	104	55	24	0,253	501 601 610	50	15000	B
60	M16	154	105	24	0,316	501 601 615	30	15000	
60	M16	204	155	24	0,398	501 601 621	20	15000	
60	M20	104	55	24	0,320	501 602 010	50	20000	
60	M20	154	105	24	0,420	501 602 015	30	20000	
60	M20	204	155	24	0,550	501 602 021	20	20000	

MODEL: 505 PLASTİK PABUÇ (6 KÖŞESİ PASLANMAZ ÇELİK) AISI 304 (INOX)

ARTICULATED FEET

Taban/Base: Güçlendirilmiş Polyamid/Reinforced Polyamide **PA**

Saplama/Spindle: AISI 304 (Inox) Paslanmaz/AISI 304 Stainless Steel **SS**

A	B	C	D		Kg	STN Stok Kod Stock Code		FM N (Newton)	Tip/Type
60	M16	104	55	24	0,253	505 601 610	50	15000	B
60	M16	154	105	24	0,316	505 601 615	30	15000	
60	M16	204	155	24	0,398	505 601 621	20	15000	
60	M20	104	55	24	0,320	505 602 010	50	20000	
60	M20	154	105	24	0,420	505 602 015	30	20000	
60	M20	204	155	24	0,550	505 602 021	20	20000	



UYARI 1-2/WARNING 1-2 → SAYFA C/PAGE C

*Özel üretim yapılır./On request special production is available.

MODEL: 501-505 PLASTİK PABUÇ

501 ARTICULATED FEET

Taban/Base: Güçlendirilmiş Polyamid
Reinforced Polyamide (PA)

Saplama/Spindle: Çinko Kaplama
Metal/Zinc Plated Steel (ZN)

505 ARTICULATED FEET

Taban/Base: Güçlendirilmiş Polyamid
Reinforced Polyamide (PA)

Saplama/Spindle: Paslanmaz AISI 304 (Inox)
AISI 304 Stainless Steel (SS)

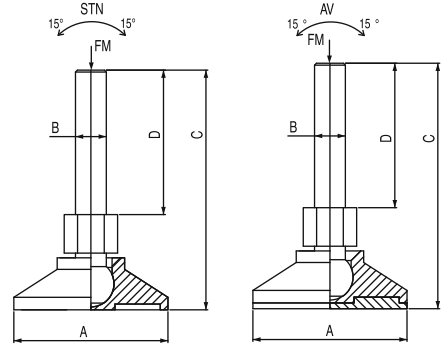

A	B	C	D		Kg	STN Stok Kod Stock Code		FM N (Newton)	Tip/Type
80	M16	104	55	24	0,259	501 801 610	40	15000	B
80	M16	154	105	24	0,322	501 801 615	30	15000	
80	M16	204	155	24	0,404	501 801 621	20	15000	
80	M20	104	55	24	0,325	501 802 010	40	20000	
80	M20	154	105	24	0,425	501 802 015	30	20000	
80	M20	204	155	24	0,555	501 802 021	20	20000	
80	M16	104	55	24	0,259	505 801 610	40	15000	
80	M16	154	105	24	0,322	505 801 615	30	15000	
80	M16	204	155	24	0,404	505 801 621	20	15000	
80	M20	104	55	24	0,325	505 802 010	40	20000	
80	M20	154	105	24	0,425	505 802 015	30	20000	
80	M20	204	155	24	0,555	505 802 021	20	20000	

MODEL: 501-505 PLASTİK PABUÇ

501 ARTICULATED FEET

Taban/Base: Güçlendirilmiş Polyamid
Reinforced Polyamide (PA)

Saplama/Spindle: Çinko Kaplama
Metal/Zinc Plated Steel (ZN)



505 ARTICULATED FEET

Taban/Base: Güçlendirilmiş Polyamid
Reinforced Polyamide (PA)

Saplama/Spindle: Paslanmaz AISI 304 (Inox)
AISI 304 Stainless Steel (SS)

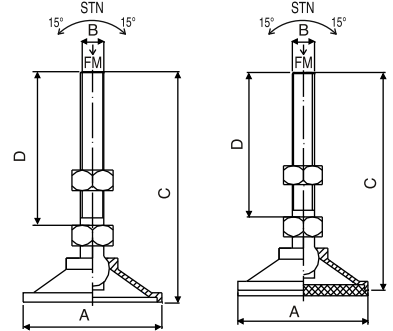

A	B	C	D		Kg	STN Stok Kod Stock Code		FM N (Newton)	Tip/Type
110	M16	106	55	24	0,304	501 111 610	30	18000	B
110	M16	156	105	24	0,367	501 111 615	25	18000	
110	M16	206	155	24	0,449	501 111 621	15	18000	
110	M16	296	250	24	0,555	501 111 629	10	18000	
110	M20	106	55	24	0,373	501 112 010	30	20000	
110	M20	156	100	24	0,470	501 112 015	25	20000	
110	M20	206	166	24	0,600	501 112 021	15	20000	
110	M20	296	250	24	0,790	501 112 031	10	20000	
110	M16	106	55	24	0,304	505 111 610	30	18000	
110	M16	156	100	24	0,367	505 111 615	25	18000	
110	M16	206	166	24	0,449	505 111 621	15	18000	
110	M16	296	250	24	0,555	505 111 629	10	18000	
110	M20	106	55	24	0,373	505 112 010	30	20000	
110	M20	156	100	24	0,470	505 112 015	25	20000	
110	M20	206	166	24	0,600	505 112 021	15	20000	
110	M20	296	250	24	0,790	505 112 029	10	20000	



UYARI 1-2/WARNING 1-2 → SAYFA C/PAGE C



*Özel üretim yapılır./On request special production is available.

MODEL: 501 PLASTİK PABUÇ (6 KÖŞESİ METAL ÇİNKO KAPLAMALI)

ARTICULATED FEET

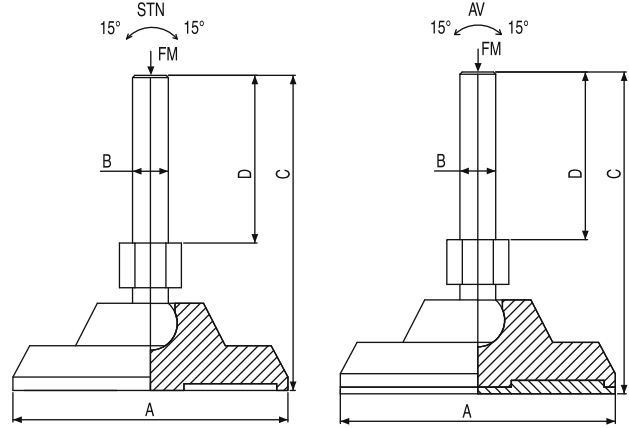
 Taban/Base: Güçlendirilmiş Polyamid/Reinforced Polyamide **PA**

 Saplama/Spindle: Çinko Kaplama Metal/Zinc Plated Steel **ZN**





A	B	C	D		Kg	STN Stok Kod Stock Code		FM N (Newton)	Tip/Type 
120	M16	124	55	24	0,380	501 121 610	10	18000	B
120	M16	174	105	24	0,445	501 121 615	10	18000	B
120	M16	224	155	24	0,525	501 121 621	8	18000	B
120	M16	314	245	24	0,645	501 121 631	8	18000	B
120	M20	124	55	24	0,445	501 122 010	10	20000	B
120	M20	174	105	24	0,545	501 122 015	10	20000	B
120	M20	224	155	24	0,675	501 122 021	8	20000	B
120	M20	314	245	24	0,865	501 122 029	8	20000	B
120	M24	174	105	24	0,685	501 122 415	10	22000	B
120	M24	224	155	24	0,860	501 122 421	8	22000	B
120	M24	314	245	24	1,130	501 122 429	8	22000	B

MODEL: 505 PLASTİK PABUÇ (6 KÖŞESİ PASLANMAZ ÇELİK) AISI 304 (INOX)

ARTICULATED FEET

 Taban/Base: Güçlendirilmiş Polyamid/Reinforced Polyamide **PA**

 Saplama/Spindle: AISI 304 (Inox) Paslanmaz/AISI 304 Stainless Steel **SS**

A	B	C	D		Kg	STN Stok Kod Stock Code		FM N (Newton)	Tip/Type 
120	M16	124	55	24	0,380	505 121 610	10	18000	B
120	M16	174	105	24	0,445	505 121 615	10	18000	B
120	M16	224	155	24	0,525	505 121 621	8	18000	B
120	M16	314	245	24	0,645	505 121 631	8	18000	B
120	M20	124	55	24	0,445	505 122 010	10	20000	B
120	M20	174	105	24	0,545	505 122 015	10	20000	B
120	M20	224	155	24	0,675	505 122 021	8	20000	B
120	M20	314	245	24	0,865	505 122 029	8	20000	B
120	M24	174	105	24	0,685	505 122 415	10	22000	B
120	M24	224	155	24	0,860	505 122 421	8	22000	B
120	M24	314	245	24	1,130	505 122 429	8	22000	B



UYARI 1-2/WARNING 1-2 → SAYFA C/PAGE C

*Özel üretim yapılır./On request special production is available.

MODEL: 507 ÇELİK - TABANLI VE MİLLİ MAFSALLI PABUÇ

ZINC PLATED STEEL BASE-SPINDLE ARTICULATED FEET

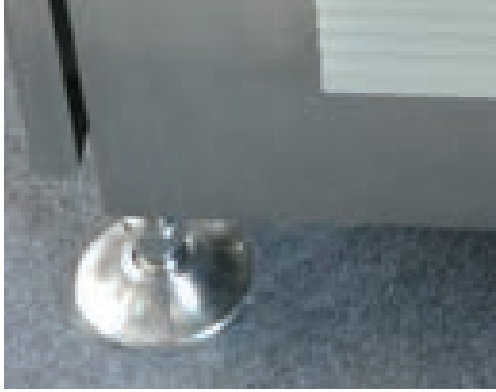

Taban/Base: Çinko Kaplama Metal - Zinc Plated Steel **ZN**

Saplama/Spindle: Çinko Kaplama Metal - Zinc Plated Steel **ZN**

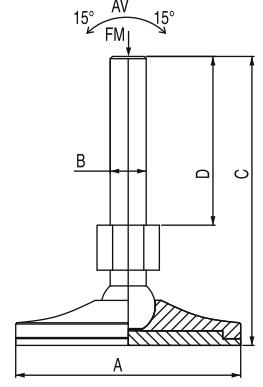
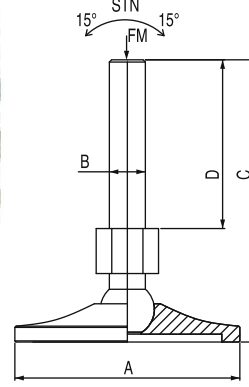
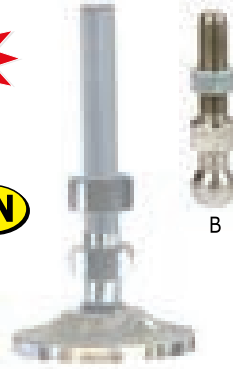

507 **ZN**



A	B	C	D		Kg	STN Stok Kod Stock Code	AV Stok Kod Stock Code		FM N (Newton)	Tip/Type 
50	M16	104	55	24	0,370	507 501 610	507 501 610AV	50	18000	B
	M16	154	105	24	0,440	507 501 615	507 501 615AV	50	18000	
	M16	204	155	24	0,530	507 501 621	507 501 621AV	40	18000	
60	M16	104	55	24	0,420	507 601 610	507 601 610AV	50	20000	
	M16	154	105	24	0,490	507 601 615	507 601 615AV	50	20000	
	M16	204	155	24	0,550	507 601 621	507 601 621AV	40	20000	
	M20	104	55	24	0,661	507 602 010	507 602 010AV	50	20000	
	M20	154	105	24	0,480	507 602 015	507 602 015AV	50	20000	
	M20	204	155	24	0,580	507 602 021	507 602 021AV	40	20000	
80	M16	104	55	24	0,710	507 801 610	507 801 610AV	50	30000	
	M16	154	105	24	0,655	507 801 615	507 801 615AV	50	30000	
	M16	204	155	24	0,735	507 801 621	507 801 621AV	40	30000	
	M20	104	55	24	0,650	507 802 010	507 802 010AV	50	30000	
	M20	154	105	24	0,760	507 802 015	507 802 015AV	50	30000	
	M20	204	155	24	0,885	507 802 021	507 802 021AV	40	30000	
100	M16	104	55	24	0,755	507 101 610	507 101 610AV	30	35000	
	M16	154	105	24	0,805	507 101 615	507 101 615AV	25	35000	
	M16	204	155	24	0,885	507 101 621	507 101 621AV	20	35000	
	M20	104	55	24	0,810	507 102 010	507 102 010AV	40	45000	
	M20	154	105	24	0,910	507 102 015	507 102 015AV	30	45000	
	M20	204	155	24	1,035	507 102 021	507 102 021AV	20	45000	
	M20	294	245	24	1,120	507 102 029	507 102 029AV	20	45000	
	M24	154	105	24	1,040	507 102 415	507 102 415AV	25	55000	
	M24	214	155	24	1,220	507 102 421	507 102 421AV	20	55000	
	M24	294	245	24	1,545	507 102 429	507 102 429AV	20	55000	
120	M16	104	55	24	0,900	507 121 610	507 121 610AV	30	45000	
	M16	154	105	24	0,960	507 121 615	507 121 615AV	20	45000	
	M16	204	155	24	1,020	507 121 621	507 121 621AV	10	45000	
	M16	294	245	24	1,230	507 121 629	507 121 629AV	10	45000	
	M20	104	55	24	1,025	507 122 010	507 122 010AV	30	45000	
	M20	154	105	24	1,075	507 122 015	507 122 015AV	25	45000	
	M20	204	155	24	1,120	507 122 021	507 122 021AV	10	45000	
	M20	294	245	24	1,370	507 122 029	507 122 029AV	10	45000	
	M24	154	105	24	1,180	507 122 415	507 122 415AV	25	55000	
	M24	204	155	24	1,360	507 122 421	507 122 421AV	10	55000	
	M24	294	245	24	1,630	507 122 429	507 122 429AV	10	55000	
	M30	204	155	24	1,850	507 123 021	507 123 021AV	10	65000	



UYARI 1-2/WARNING 1-2→SAYFA C/PAGE C

*Özel üretim yapılır./On request special production is available.

MODEL: 560 ÇELİK - TABANLI VE MİLLİ MAFSALLI PABUÇ

STAINLESS STEEL BASE-SPINDLE ARTICULATED FEET

Taban/Base: Paslanmaz Çelik/Stainless Steel

Saplama/Spindle: Paslanmaz Çelik/Stainless Steel

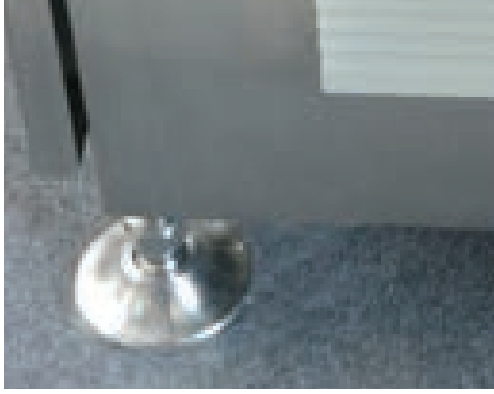





560 SS

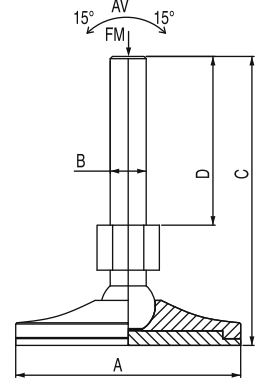
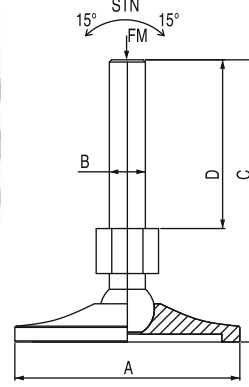

SS

SS



A	B	C	D		Kg	STN Stok Kod Stock Code	AV Stok Kod Stock Code		FM N (Newton)	Tip/Type 
50	M16	104	55	24	0,370	560 501 610	560 501 610AV	50	18000	B
	M16	154	105	24	0,440	560 501 615	560 501 615AV	50	18000	
	M16	204	155	24	0,530	560 501 621	560 501 621AV	40	18000	
60	M16	104	55	24	0,420	560 601 610	560 601 610AV	50	20000	
	M16	154	105	24	0,490	560 601 615	560 601 615AV	50	20000	
	M16	204	155	24	0,550	560 601 621	560 601 621AV	40	20000	
	M20	104	55	24	0,661	560 602 010	560 602 010AV	50	20000	
	M20	154	105	24	0,480	560 602 015	560 602 015AV	50	20000	
	M20	204	155	24	0,580	560 602 021	560 602 021AV	40	20000	
80	M16	104	55	24	0,710	560 801 610	560 801 610AV	50	30000	
	M16	154	105	24	0,655	560 801 615	560 801 615AV	50	30000	
	M16	204	155	24	0,735	560 801 621	560 801 621AV	40	30000	
	M20	104	55	24	0,650	560 802 010	560 802 010AV	50	30000	
	M20	154	105	24	0,760	560 802 015	560 802 015AV	50	30000	
	M20	204	155	24	0,885	560 802 021	560 802 021AV	40	30000	
100	M16	104	55	24	0,755	560 101 610	560 101 610AV	30	35000	
	M16	154	105	24	0,805	560 101 615	560 101 615AV	25	35000	
	M16	204	155	24	0,885	560 101 621	560 101 621AV	20	35000	
	M20	104	55	24	0,810	560 102 010	560 102 010AV	40	45000	
	M20	154	105	24	0,910	560 102 015	560 102 015AV	30	45000	
	M20	204	155	24	1,035	560 102 021	560 102 021AV	20	45000	
	M20	294	245	24	1,120	560 102 029	560 102 029AV	20	45000	
	M24	154	105	24	1,040	560 102 415	560 102 415AV	25	55000	
	M24	214	155	24	1,220	560 102 421	560 102 421AV	20	55000	
	M24	294	245	24	1,545	560 102 429	560 102 429AV	20	55000	
120	M16	104	55	24	0,900	560 121 610	560 121 610AV	30	45000	
	M16	154	105	24	0,960	560 121 615	560 121 615AV	20	45000	
	M16	204	155	24	1,020	560 121 621	560 121 621AV	10	45000	
	M16	294	245	24	1,230	560 121 629	560 121 629AV	10	45000	
	M20	104	55	24	1,025	560 122 010	560 122 010AV	30	45000	
	M20	154	105	24	1,075	560 122 015	560 122 015AV	25	45000	
	M20	204	155	24	1,120	560 122 021	560 122 021AV	10	45000	
	M20	294	245	24	1,370	560 122 029	560 122 029AV	10	45000	
	M24	154	105	24	1,180	560 122 415	560 122 415AV	25	55000	
	M24	204	155	24	1,360	560 122 421	560 122 421AV	10	55000	
	M24	294	245	24	1,630	560 122 429	560 122 429AV	10	55000	
	M30	204	155	24	1,850	560 123 021	560 123 021AV	10	65000	



UYARI 1-2/WARNING 1-2 → SAYFA C/PAGE C

*Özel üretim yapılır./On request special production is available.

MODEL: 580 METAL TABAN (SEGMANLI) SABİT PABUÇ (Çinko Kaplamalı)



ZINC PLATED STEEL BASE-SPINDLE (with SNAP RING) **(ZN)** FIX FEET

Malzeme/Material: Çinko Kaplama Metal/Zinc Plated Steel **(ZN)**

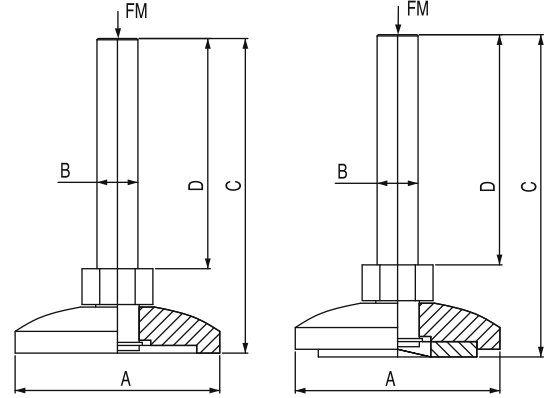

C2





A	C	D	M		Kg	STN Stok Kod Stock Code	AV Stok Kod Stock Code		FM N (Newton)	Tip/Type 
80	103	65	16	24	0,700	580 801 610	580 801 610AV	50	18000	C2
80	153	115	16	24	0,780	580 801 615	580 801 615AV	50	18000	
80	203	165	16	24	0,860	580 801 621	580 801 621AV	50	18000	
100	103	65	16	24	0,865	580 101 610	580 101 610AV	40	20000	
100	153	115	16	24	0,940	580 101 615	580 101 615AV	25	20000	
100	203	165	16	24	1,020	580 101 621	580 101 621AV	20	20000	
100	153	115	20	24	1,030	580 102 010	580 102 010AV	40	20000	
100	203	165	20	24	1,150	580 102 015	580 102 015AV	20	20000	
120	103	65	16	24	1,030	580 121 610	580 121 610AV	30	25000	
120	153	115	16	24	1,110	580 121 615	580 121 615AV	20	25000	
120	203	165	16	24	1,190	580 121 621	580 121 621AV	10	25000	
120	153	115	20	24	1,200	580 122 015	580 122 015AV	20	25000	
120	203	165	20	24	1,320	580 122 021	580 122 021AV	10	25000	
120	153	115	24	24	1,275	580 122 415	580 122 415AV	20	27000	
120	203	165	24	24	1,475	580 122 421	580 122 421AV	10	27000	

MODEL: 590 (INOX) PASLANMAZ TABAN (SEGMANLI) SABİT PABUÇ

STAINLESS STEEL BASE-SPINDLE (with SNAP RING) FIX FEET

Malzeme/Material: AISI 304 Paslanmaz Çelik/Stainless Steel AISI 304 (INOX) **(SS)**

A	C	D	M		Kg	STN Stok Kod Stock Code	AV Stok Kod Stock Code		FM N (Newton)	Tip/Type 
80	103	65	16	24	0,700	590 801 610	590 801 610AV	50	18000	C2
80	153	115	16	24	0,780	590 801 615	590 801 615AV	50	18000	
80	203	165	16	24	0,860	590 801 621	590 801 621AV	50	18000	
100	103	65	16	24	0,865	590 101 610	590 101 610AV	40	20000	
100	153	115	16	24	0,940	590 101 615	590 101 615AV	25	20000	
100	203	165	16	24	1,020	590 101 621	590 101 621AV	20	20000	
100	153	115	20	24	1,030	590 102 010	590 102 010AV	40	20000	
100	203	165	20	24	1,150	590 102 015	590 102 015AV	20	20000	
120	103	65	16	24	1,030	590 121 610	590 121 610AV	30	25000	
120	153	115	16	24	1,110	590 121 615	590 121 615AV	20	25000	
120	203	165	16	24	1,190	590 121 621	590 121 621AV	10	25000	
120	153	115	20	24	1,200	590 122 015	590 122 015AV	20	25000	
120	203	165	20	24	1,320	590 122 021	590 122 021AV	10	25000	
120	153	115	24	24	1,275	590 122 415	590 122 415AV	20	27000	
120	203	165	24	24	1,475	590 122 421	590 122 421AV	10	27000	



UYARI 1/WARNING 1
SAYFA C/PAGE C

*Özel üretim yapılır./On request special production is available.

MODEL: 507-560 MAFSALLI METAL VE PASLANMAZ TABAN

STEEL ARTICULATED BASE

Malzeme/Material: *Metal Üzeri Çinko Kaplama/Zinc Plated Steel **(ZN)** 507

Malzeme/Material: **AISI 304 (Inox) Paslanmaz/AISI 304 Stainless Steel **(SS)** 560

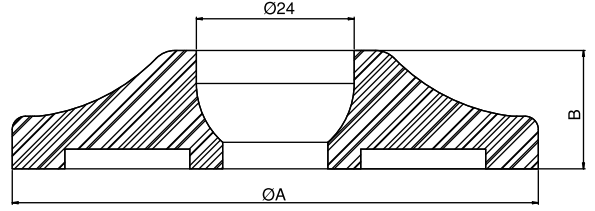

ØA Taban Çapı (Base Diameter)	Kg	(ZN)		(SS)		B	100
		STN Stok Kod Stock Code	AV Stok Kod Stock Code	STN Stok Kod Stock Code	AV Stok Kod Stock Code		
50	0,110	507 000 050	507 000 050AV	560 000 050	560 000 050AV	18	100
60	0,170	507 000 060	507 000 060AV	560 000 060	560 000 060AV	18	100
80	0,300	507 000 080	507 000 080AV	560 000 080	560 000 080AV	18	80
100	0,515	507 000 100	507 000 100AV	560 000 100	560 000 100AV	18	40
120	0,730	507 000 120	507 000 120AV	560 000 120	560 000 120AV	18	30

MODEL: 508-570 METAL VE PASLANMAZ SEGMANLI SABİT TABAN

STEEL FIXED BASE (WITH SNAP RING)

Malzeme/Material: *Çinko Kaplamalı Metal/Zinc Plated Steel **(ZN)**

Malzeme/Material: **AISI 304 (Inox) Paslanmaz/AISI 304 Stainless Steel **(SS)**

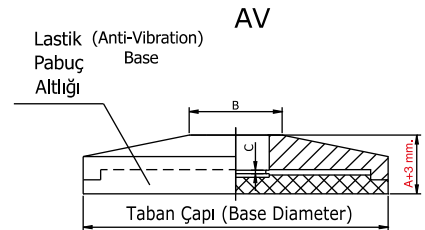
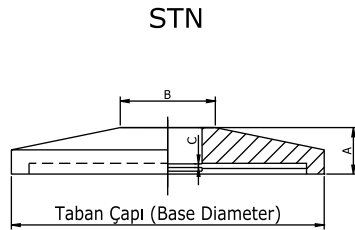

Ø Taban Çapı (Base Diameter)	Kg	(ZN)		(SS)		A	B	C	100
		STN Stok Kod Stock Code	AV Stok Kod Stock Code	STN Stok Kod Stock Code	AV Stok Kod Stock Code				
80	0,500	508 000 080	508 000 080AV	570 000 080	570 000 080AV	20	25	5	80
100	0,650	508 000 100	508 000 100AV	570 000 100	570 000 100AV	20	25	5	40
120	0,820	508 000 120	508 000 120AV	570 000 120	570 000 120AV	20	25	5	30
150	0,980	508 000 150	508 000 150AV	570 000 150	570 000 150AV	20	25	5	25



UYARI 1/WARNING 1→SAYFA C/PAGE C

*Özel üretim yapılır./On request special production is available.

MODEL: 230 KARE PROFİL KILAVUZLARI

THREADED TUBE ENDS (FOR SQUARE PROFILE)

Ⓜ Güçlendirilmiş Polyamid + Piring/Reinforced Polyamide Ⓜ + Nickel Plated Brass Ⓜ

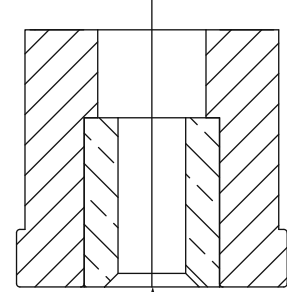

FM

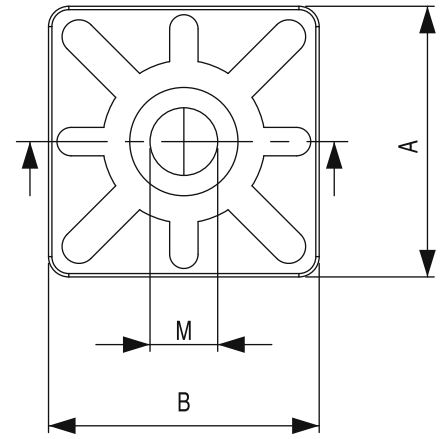

A	B	M	Kalınlık Thickness	Kg	Stok Kod Stock Code	FM N (Newton)	
25	25	8	1,5	0,055	230 250 815	5500	100
25	25	10	1,5	0,050	230 251 015	5500	100
25	25	12	1,5	0,045	230 251 215	5500	100
30	30	8	1,5	0,065	230 300 815	5500	100
30	30	10	1,5	0,060	230 301 015	5500	100
30	30	12	1,5	0,055	230 301 215	5500	100
30	30	16	1,5	0,040	230 301 615	5500	100
30	30	10	2	0,060	230 301 020	5500	100
30	30	12	2	0,055	230 301 220	5500	100
30	30	16	2	0,040	230 301 620	5500	100
35	35	10	1,5	0,070	230 351 015	5500	75
35	35	12	1,5	0,060	230 351 215	5500	75
35	35	16	1,5	0,050	230 351 615	5500	75
35	35	10	2	0,070	230 351 020	5500	75
35	35	12	2	0,060	230 351 220	5500	75
35	35	16	2	0,050	230 351 620	5500	75
38	38	10	1,6	0,070	230 381 016	6000	50
38	38	12	1,6	0,065	230 381 216	6000	50
38	38	16	1,6	0,050	230 381 616	6000	50
38	38	10	3	0,070	230 381 030	6000	50
38	38	12	3	0,065	230 381 230	6000	50
38	38	16	3	0,050	230 381 630	6000	50
40	40	10	1,5	0,075	230 401 015	6000	100
40	40	12	1,5	0,065	230 401 215	6000	100
40	40	16	1,5	0,050	230 401 615	6000	100
40	40	10	2	0,075	230 401 020	6000	100
40	40	12	2	0,065	230 401 220	6000	100
40	40	16	2	0,050	230 401 620	6000	100
50	50	12	1,5	0,100	230 501 215	10000	40
50	50	16	1,5	0,080	230 501 615	10000	40
50	50	20	1,5	0,100	230 502 015	10000	40
50	50	12	2	0,100	230 501 220	10000	40
50	50	16	2	0,080	230 501 620	10000	40
50	50	20	2	0,100	230 502 020	10000	40
50	50	12	2,5	0,100	230 501 225	10000	40
50	50	16	2,5	0,080	230 501 625	10000	40
50	50	20	2,5	0,100	230 502 025	10000	40
60	60	16	2	0,110	230 601 620	15000	20
60	60	20	2	0,130	230 602 020	15000	20

HD Hesaplı Dizi
Economic Series

Hesaplı Dizi

FM

231 40X XXX



UYARI 1/WARNING 1→SAYFA C/PAGE C

*Özel üretim yapılır./On request special production is available.

MODEL: 235 YUVARLAK PROFİL KILAVUZLARI

THREADED TUBE ENDS

Ⓜ Güçlendirilmiş Polyamid + Pring/Reinforced Polyamide ⓅPA + Bush in Nickel Plated Brass ⓅBR

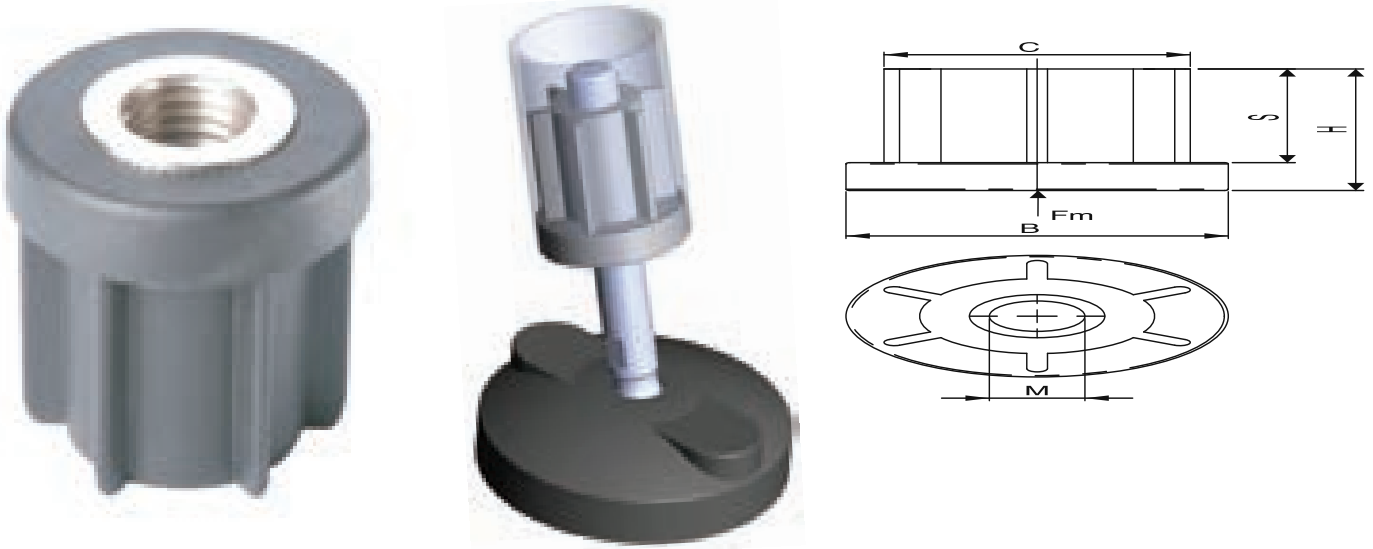

M	B	C	H	S	øDış øExt	øİç øInt	Kalınlık Thickness	FM N (Newton)	Kg	Stok Kod Stock Code		
10	38	35,5	43	34	38	35	1,5	5000	0,055	235 381 510	25	
12									0,050	235 381 512		
14									0,045	235 381 514		
16									0,040	235 381 516		
10	42	39,9	42	34	42,4	39,4	1,5	6000	0,075	235 421 510	50	
12									0,065	235 421 512		
14									0,060	235 421 514		
16									0,050	235 421 516		
20									0,070	235 421 520		
12	48	45,8	49	38	48,3	45,3	1,5	6000	0,080	235 481 512	15	
14									0,070	235 481 514		
16									0,060	235 481 516		
20									0,080	235 481 520		
12		45	49	38	48,3	44,3	2	6000	0,080	235 482 012		
14									0,070	235 482 014		
16									0,060	235 482 016		
20									0,080	235 482 020		
16	60	56,7	54,7	44,5	60,3	56,3	2	8000	0,100	235 602 016	15	
20									0,110	235 602 020		
24									0,120	235 602 024		
16		56	50	44,5	60,3	55,3	2,5		8000	0,100		235 602 516
20										0,110		235 602 520
24										0,120		235 602 524



UYARI 1/WARNING 1→SAYFA C/PAGE C

*Özel üretim yapılır./On request special production is available.

MODEL: 220 PLASTİK İKİLİ AYAK (AÇILI) BORU VE PROFİL BAĞLANTILI

BIPOP (ANGLED)

M PA

Yeni
New



220 211 110

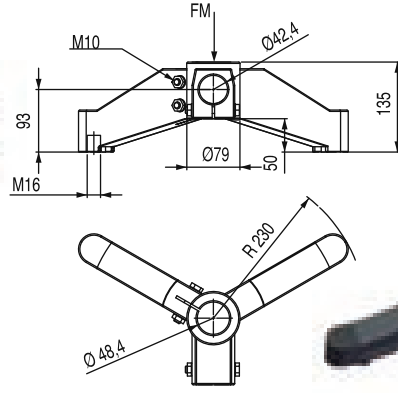

Yeni
New



220 211 111

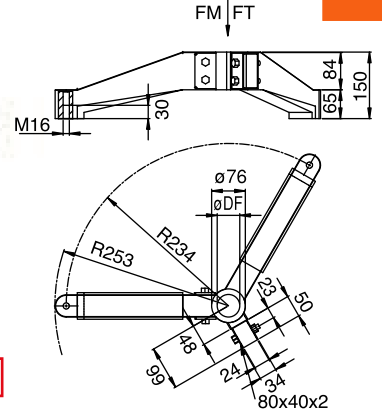

FM(N)	FT(N)	FD(N)	DF	Kg	Stok Kod Stock Code	
13000	80000	7500	48,3	1,600	220 211 110	20
13000	80000	7500	48,3	1,600	220 211 111	20

MODEL: 220 PLASTİK İKİLİ AYAK (AÇISIZ) DÜZ ve BAĞLANTILI

BIPOP

M PA



220 211 120

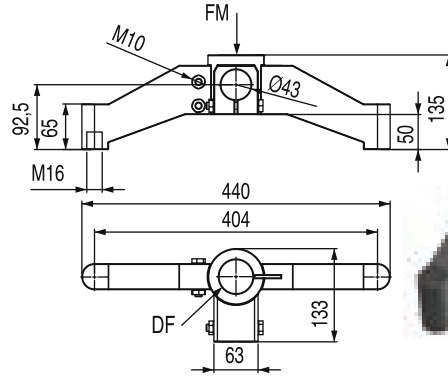

220 211 121

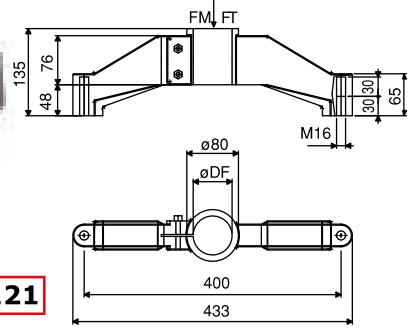

FM(N)	FT(N)	FD(N)	DFØ	Kg	Stok Kod Stock Code	
13000	80000	4500	48,3	0,920	220 211 120	35
13000	80000	4500	48,3	0,880	220 211 121	35

MODEL: 220 PLASTİK ÜÇLÜ AYAK

TRIPOD SUPPORT BASES

M PA



FM(N)	FT(N)	DFØ	Kg	Stok Kod Stock Code	
16000	8500	48,3	1,080	220 211 130	15

(N): Newton

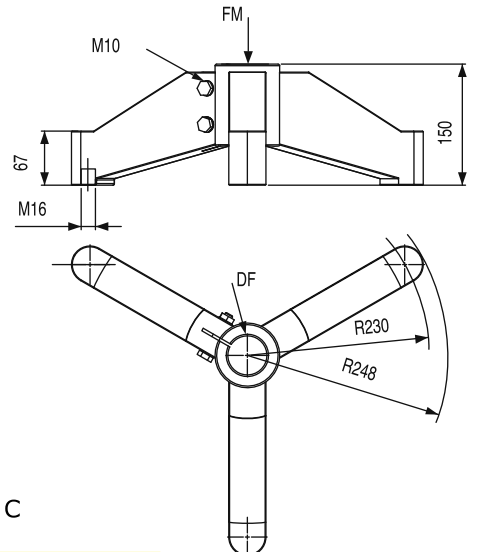

220 211 130



UYARI 1/WARNING 1→ SAYFA C/PAGE C

*Özel üretim yapılır./On request special production is available.



ÇAĞRI[®]
ENDÜSTRİ A.Ş.

ALHAN

**KONVEYÖR ELEMANLARI
CONVEYOR COMPONENTS**

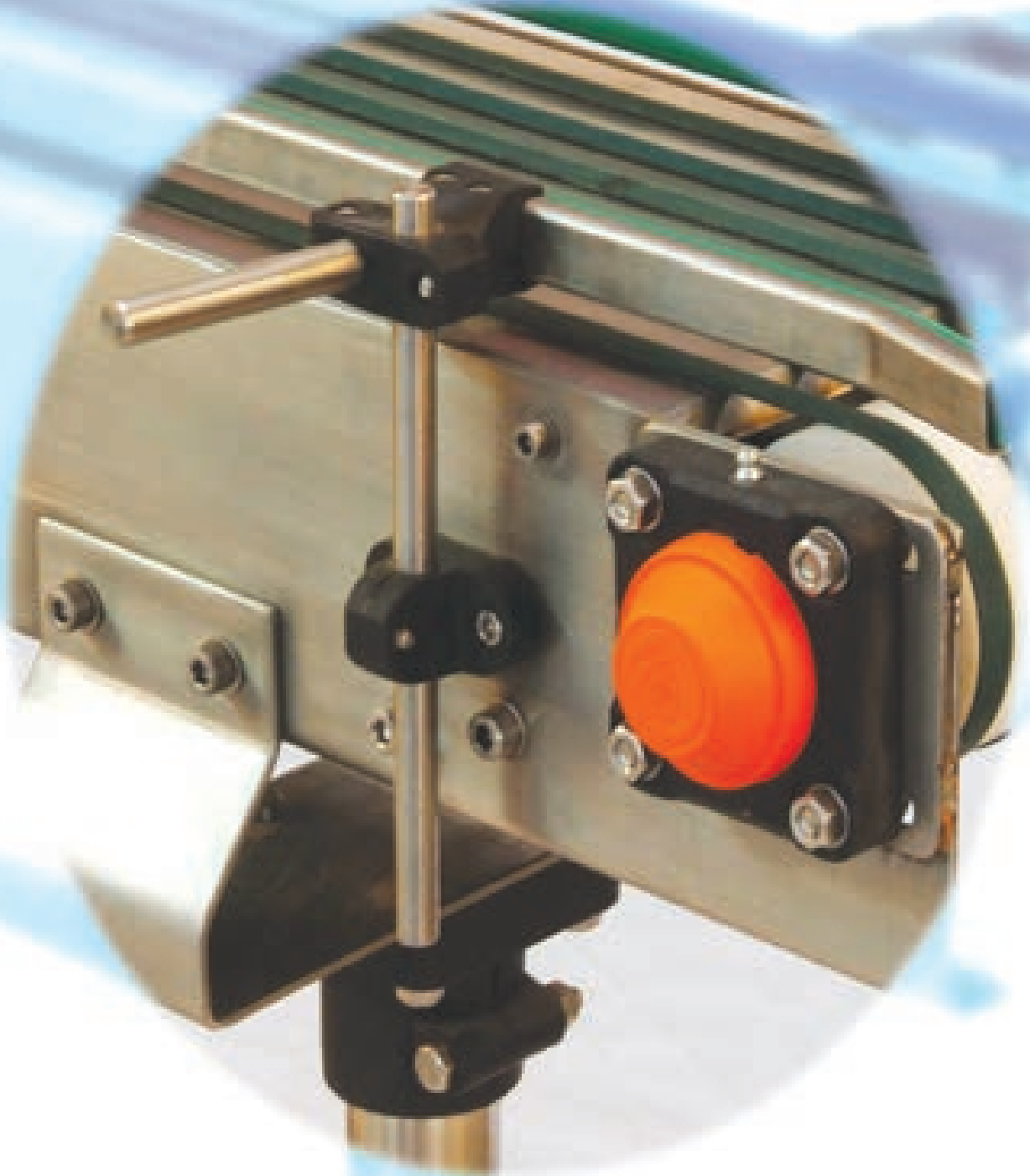



ÇAĞRI[®]
ENDÜSTRİ A.Ş.

ALHAN

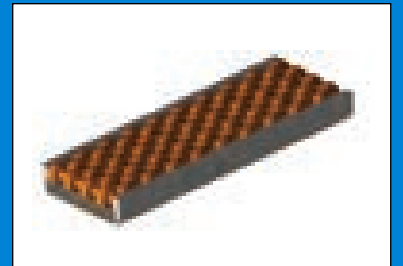
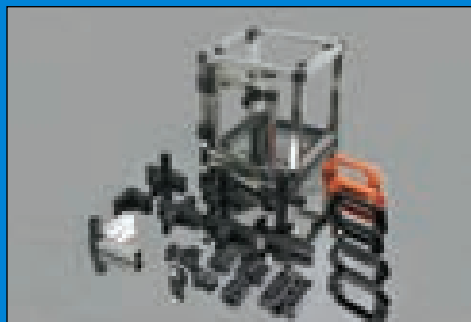
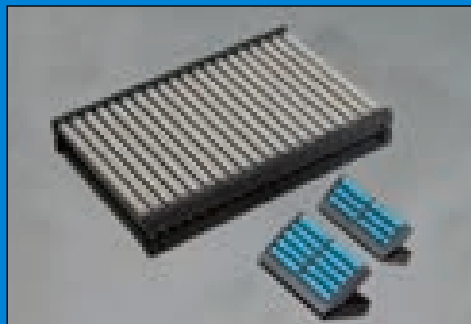
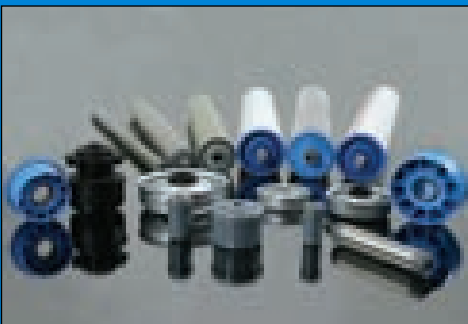

DAR TEKLİ MENGENE (MİLSİZ)/SINGLE CLAMP

M PA SS

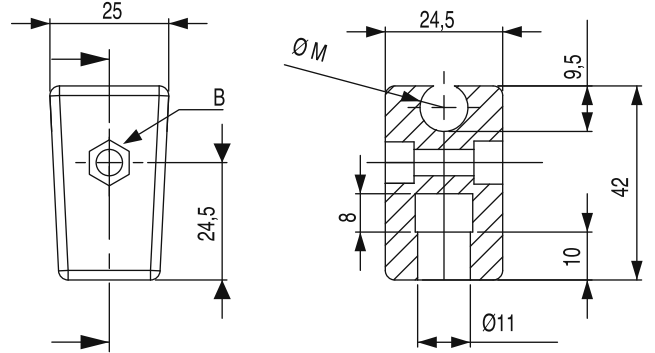

ØM	B	Renk Colour	Kg	Stok Kod Stock Code	
10	5	Siyah/Black	0,025	210 DTT 010	100
12	5	Siyah/Black	0,025	210 DTT 012	100

DAR TEKLİ MENGENE (MİLLİ)/SINGLE CLAMP WITH ROD

M PA SS

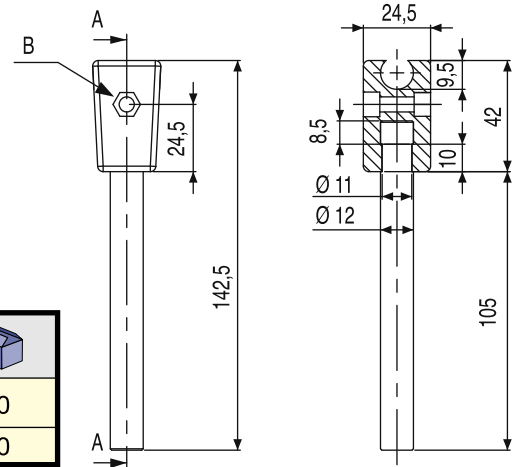
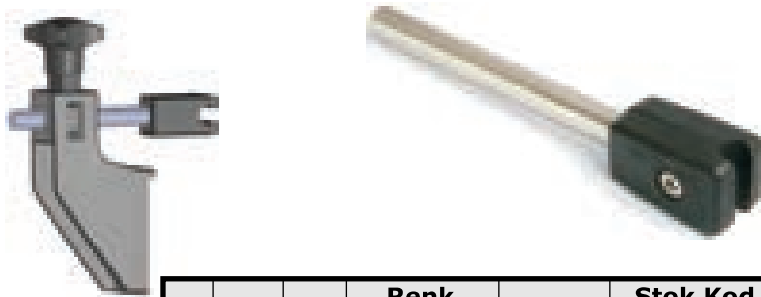

A	ØM	B	Renk Colour	Kg	Stok Kod Stock Code	
12	10	5	Siyah/Black	0,125	210 DTT M10	50
12	12	5	Siyah/Black	0,125	210 DTT M12	50

GENİŞ TUTUCU TEKLİ ÇUBUK MENGENESİ (MİLSİZ)/GUIDE RAIL CLAMPS

M PA

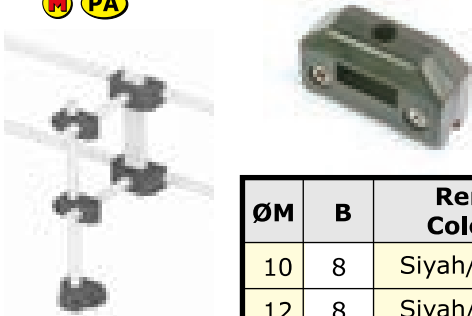

ØM	B	Renk Colour	Kg	Stok Kod Stock Code	
10	8	Siyah/Black	0,050	210 GTT 010	75
12	8	Siyah/Black	0,050	210 GTT 012	75

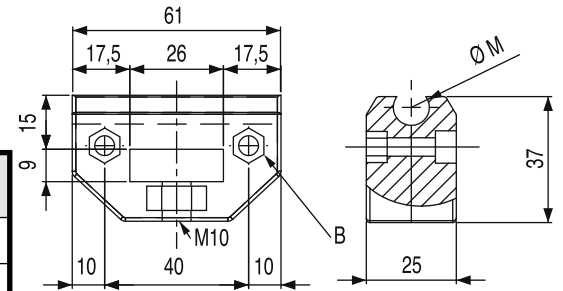

GENİŞ TUTUCU TEKLİ ÇUBUK MENGENESİ (MİLLİ)/GUIDE RAIL CLAMP WITH ROD

M PA SS

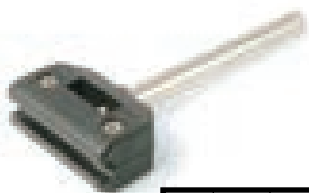

A	ØM	B	Renk Colour	Kg	Stok Kod Stock Code	
12	10	8	Siyah/Black	0,150	210 GTT M10	30
12	12	8	Siyah/Black	0,150	210 GTT M12	30

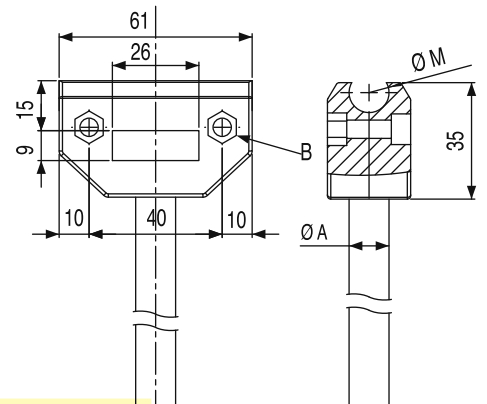

*Özel üretim yapılır./On request special production is available.

DAR SIRTLI MENGENE MİLSİZ/SINGLE CLAMP

M PA SS

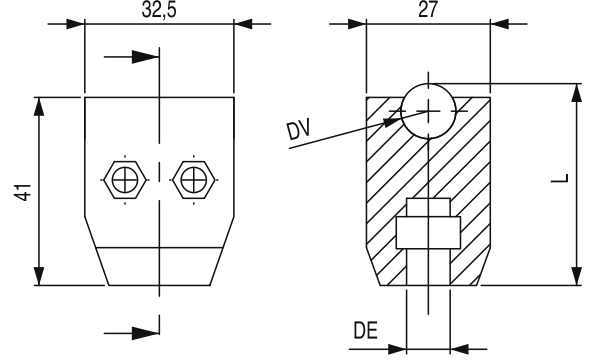
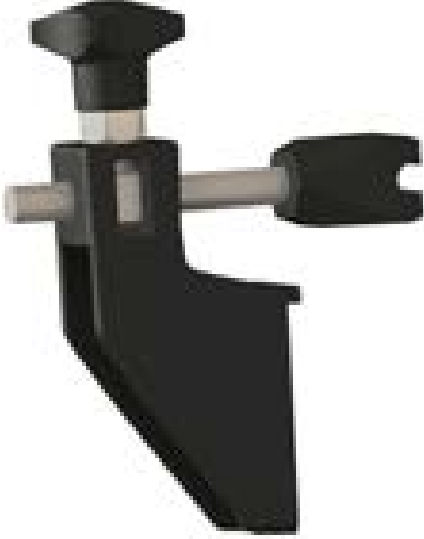

DV	DE	L	Kg	Stok Kod Stock Code	
8	12	43	0,040	210 DTY 008	100
10	12	43	0,040	210 DTY 010	
12	12	44	0,040	210 DTY 012	

DAR SIRTLI MENGENE TEKLİ ÇUBUK MİLLİ/SINGLE CLAMP WITH ROD

M PA SS

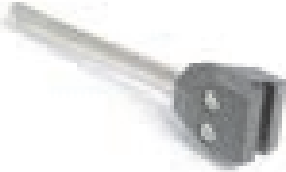

DV	DE	L	Kg	Stok Kod Stock Code	
8	12	43	0,135	210 DTY M08	50
10	12	43	0,135	210 DTY M10	
12	12	44	0,135	210 DTY M12	
8	12	43	0,135	210 DTF M08	
10	12	43	0,135	210 DTF M10	
12	12	44	0,135	210 DTF M12	

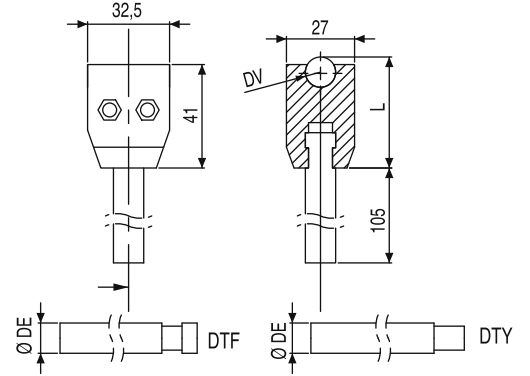

BALIK SIRTİ PROFİL İÇİN GENİŞ MENGENE (AÇIK)/SINGLE CLAMP WITH PROFILE

M PA SS

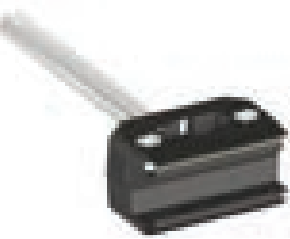

DE	Kg	Stok Kod Stock Code	
12	0,150	210 DTY A04	30
12	0,150	210 DTF A04	

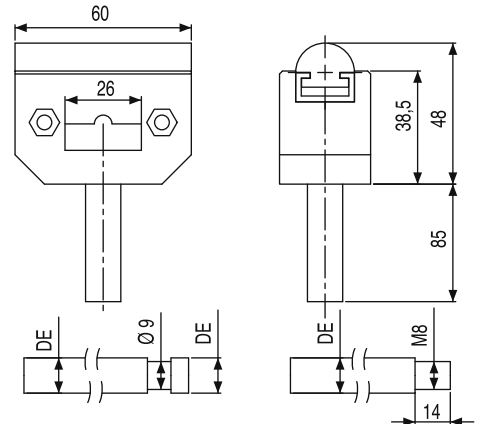

*Özel üretim yapılır./On request special production is available.

BALIK SIRTİ PROFİL İÇİN GENİŞ MENGENE (AÇIK)/SINGLE CLAMP

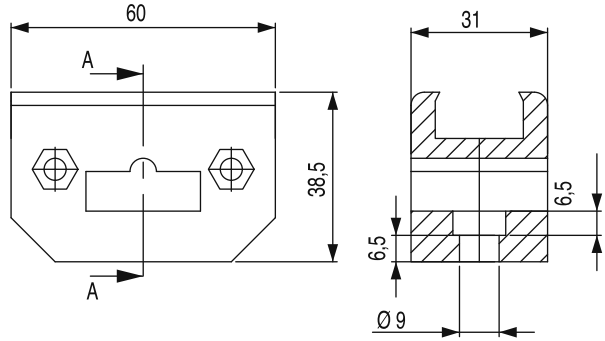

DE	Kg	Stok Kod Stock Code	
-	0,050	800 210 133	75

BALIK SIRTİ PROFİL İÇİN GENİŞ MENGENE (KAPALI)/SINGLE CLAMP

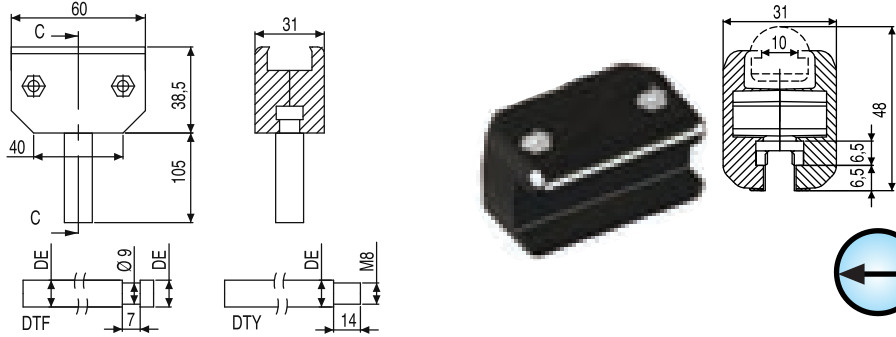

DE	Kg	Stok Kod Stock Code		Stok Kod Stock Code	
12	0,18	800 240 130		800 240 130F	30
14	0,20	800 240 131		800 240 131F	30
16	0,21	800 240 132		800 240 132F	30

DE	Kg	Stok Kod Stock Code	
12	0,060	800 210 134	75

BALIK SIRTİ PROFİL/SINGLE CLAMP

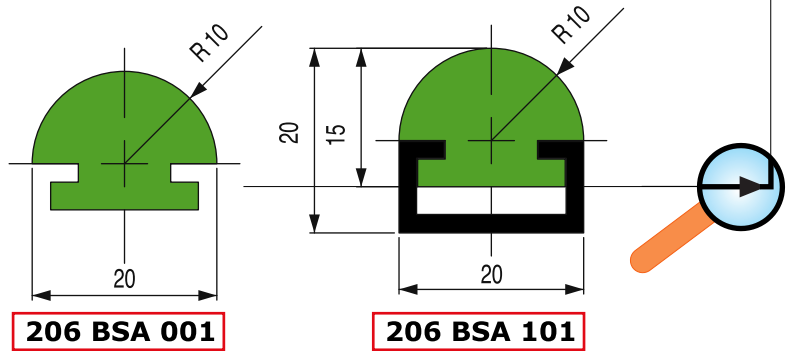
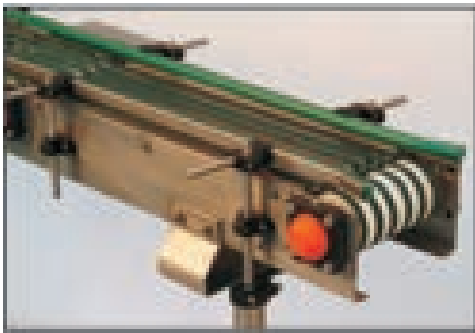

206 BSA 001

206 BSA 101

Profil Bölümü/Profiles: BSA

	Kılavuz/Guide	L	Malzeme/Material	Kg/m	Stok Kod Stock Code
	C 2010 SS	2	Alpolen® 1000 - Yeşil / Green	0,70	206 BSA 101
	C 2010 SS	2	Alpolen® 1000 - Siyah / Black	0,70	206 BSA 102
	C 2010 ZN	2	Alpolen® 1000 - Yeşil / Green	0,70	206 BSA 201
	C 2010 ZN	2	Alpolen® 1000 - Siyah / Black	0,70	206 BSA 202
		2	Alpolen® 1000 - Yeşil / Green	0,19	206 BSA 001
		2	Alpolen® 1000 - Siyah / Black	0,19	206 BSA 002

Stainless Steel L: Standart Uzunluk (metre)/Standart Length (meter)

*Özel üretim yapılır./On request special production is available.

KONSOL MENGENESİ (İKİLİ)/CLAMPS FOR ROUND PROFILE GUIDES

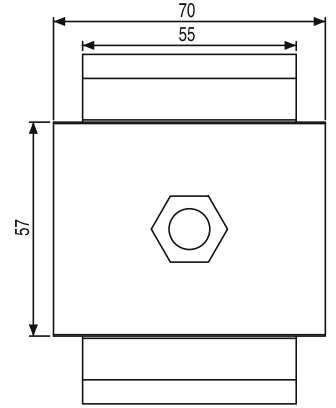
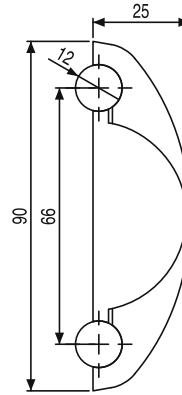
Kg	Stok Kod Stock Code	
0,080	210 011 100	25

KONSOL MENGENE TAKIMI (İKİLİ)/CLAMPS FOR ROUND PROFILE GUIDES (WITH PIN)

 AISI 304

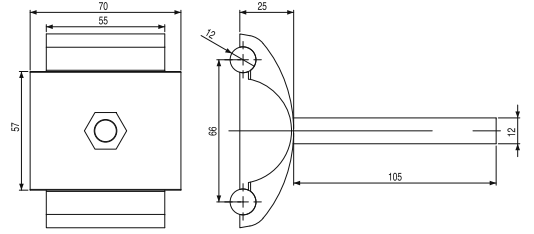
Kg	Stok Kod Stock Code	
0,195	210 010 161	20

MENGENE TAKIMI (BALIK SIRTI İKİLİ MENGENE)/DOUBLE CLAMP WITH ROD

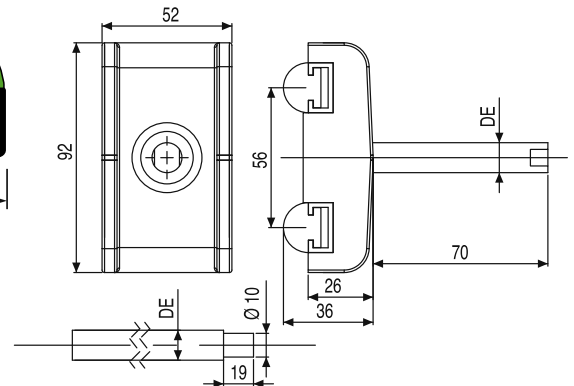
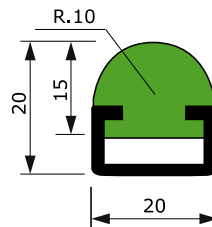
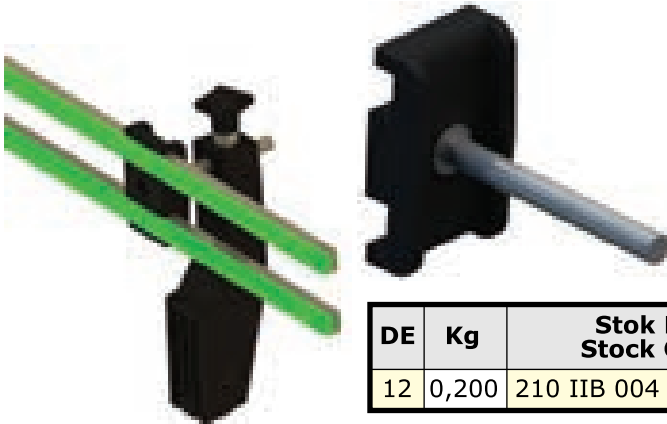



DE	Kg	Stok Kod Stock Code	
12	0,200	210 IIB 004	50

*Özel üretim yapılır./On request special production is available.

BALIK SIRTI PROFİL İKİLİ MENGENE (MİLSİZ)/SINGLE CLAMP

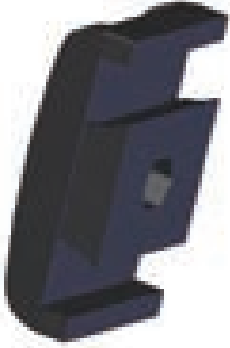
M PA



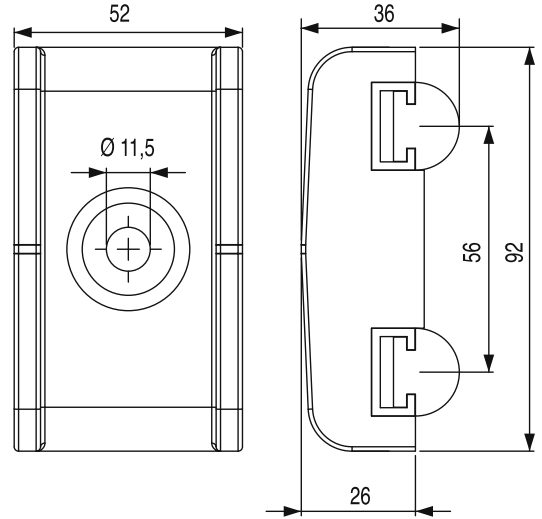

DE	Kg	Stok Kod Stock Code	
-	0,090	211 IIB 000	25

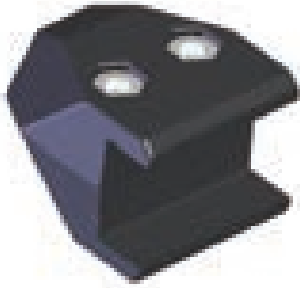

BALIK SIRTI PROFİL DAR TEKLİ MENGENE (MİLSİZ)/SINGLE CLAMP WITH PROFILE

M PA SS



DE	Kg	Stok Kod Stock Code	
12	0,035	210 IIB D04	100

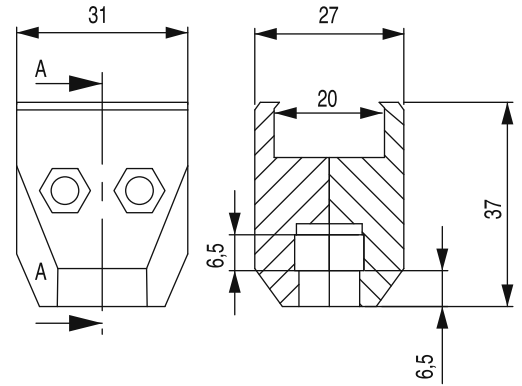

DAR BALIK SIRTI PROFİL TEKLİ MENGENE (MİLLİ)/SINGLE CLAMP WITH ROD

M PA SS



DE	Kg	Stok Kod Stock Code	
12	0,130	210 IIB E04	50
12	0,130	210 IIB F04	

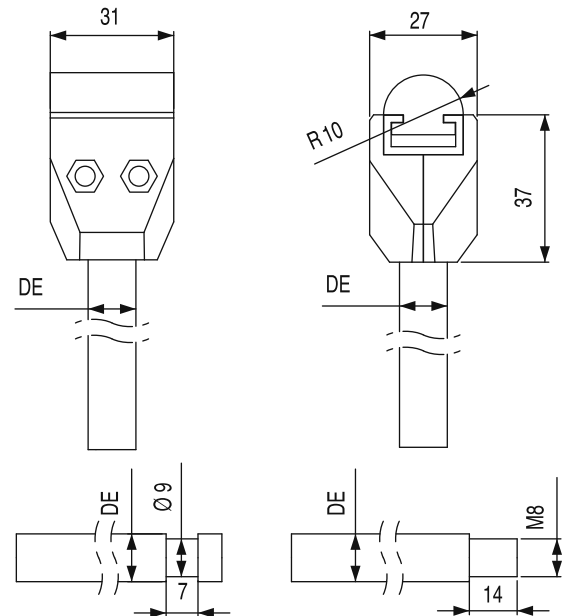

*Özel üretim yapılır./On request special production is available.

60mm PVC PROFİL İÇİN MENGENE/SINGLE CLAMP

M PA SS

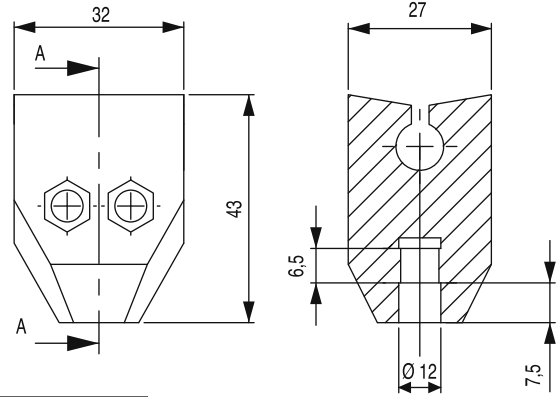
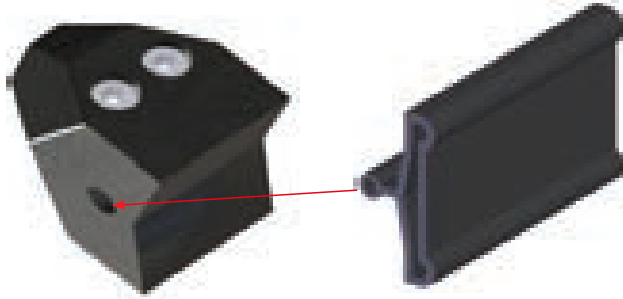

DE	Kg	Stok Kod Stock Code	
12	0,035	211 60P D04	100

60mm PVC PROFİL İÇİN MENGENE (MİLLİ)/SINGLE CLAMP WITH ROD

M PA SS

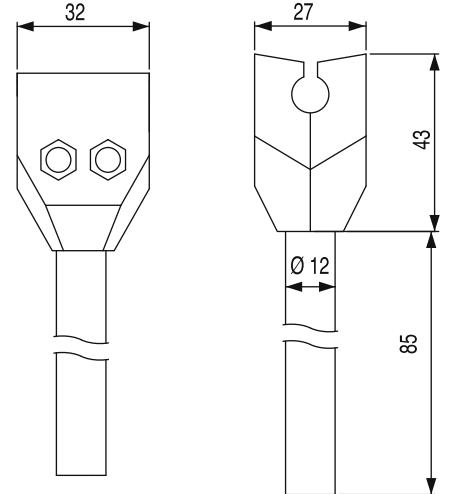

Kg	Stok Kod Stock Code	
0,135	211 60P MLL	50

PVC KENAR DAYAMA PROFİLİ/PVC SIDE GUIDES

M PVC

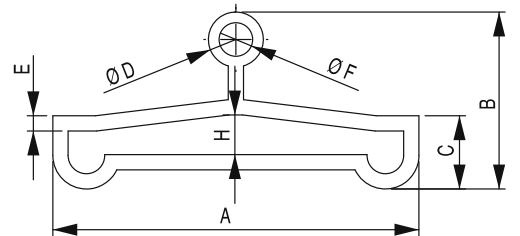

Profil Bölümü/Profiles:"YD4"

M	Kg	A	B	C	D	E	F	H	L	Stok Kod Stock Code
PVC Siyah / Black	0,600	60	29	12	9	2,5	5,5	6,5	6	207 YD4 060
PVC Beyaz / White	0,600	60	29	12	9	2,5	5,5	6,5	6	207 YD4 066

L:Standart Uzunluk (metre)/Standart Length (meter)

*Özel üretim yapılır./On request special production is available.

PASLANMAZ MENGENE MİLİ/STAINLESS STEEL ADJUSTING RODS (AISI 304) FOR CLAMPS

M SS

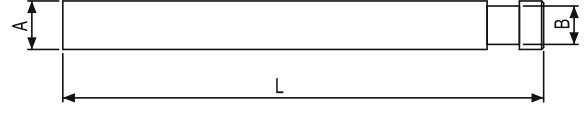

A	B	L	Kg	Stok Kod Stock Code	
M8	12	120	0,095	210 012 128	100
M8	12	200	0,165	210 012 208	50
M10	12	120	0,100	210 012 121	100
M10	12	200	0,165	210 012 201	50
M10	12	120	0,125	210 012 122BS	100
M10	12	200	0,185	210 012 202BS	50

A	B	L	Kg	Stok Kod Stock Code	
12	11,1	120	0,105	210 012 122	75
12	11,1	200	0,165	210 012 123	50

YÜSSÜK KONSOL GÖVDE TAKIMI İÇİN/EYEBOLT FOR KNOB

M BR SS

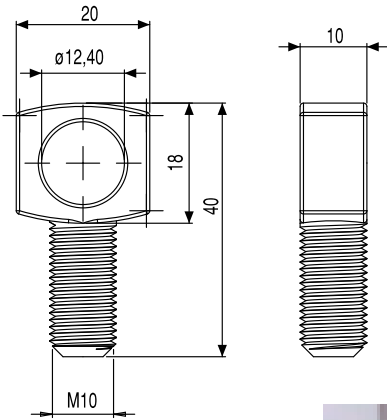

**Hesaplı
Dizi**

**Yeni
New**

Malzeme Material	Kg	Stok Kod Stock Code	
* PA	0,005	210 122 100	100
BR	0,030	210 222 100	100
SS	0,030	210 322 100	100



*Özel üretim yapılır./On request special production is available.

210 DİŞİ TUTGAÇLAR/KNOBS

M Güçlendirilmiş Polyamid+Krom Kaplama/Reinforced Polyamide (PA6)+Bushings in Nickel Plated Brass

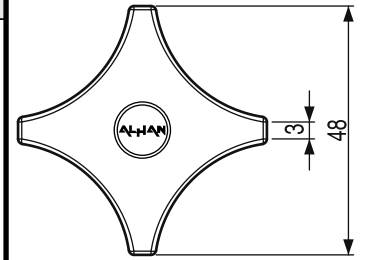
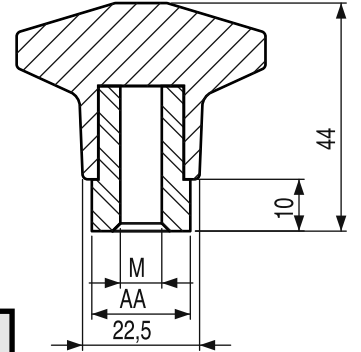
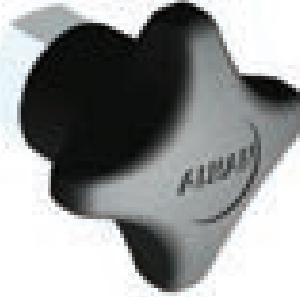
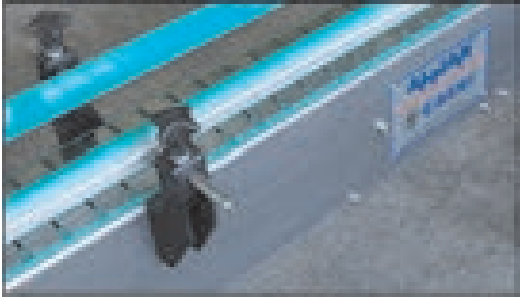

M	AA	A	Malzeme/Material		Kg	Stok Kod Stock Code	100
M6	21	24	Güçlendirilmiş Polyamid Reinforced Polyamide		0,065	210 D06 224	100
M8	21	24			0,070	210 D08 224	
M10	21	24			0,065	210 D10 224	
M12	21	24			0,060	210 D12 224	
M6	19	24	Siyah Black		0,065	210 D06 024	
M8	19	24			0,070	210 D08 024	
M10	19	24			0,065	210 D10 024	
M12	19	24			0,060	210 D12 024	



210 ERKEK TUTGAÇLAR/KNOBS

M Güçlendirilmiş Polyamid+Krom Kaplama/Reinforced Polyamide (PA6)+Bushings in Nickel Plated Brass

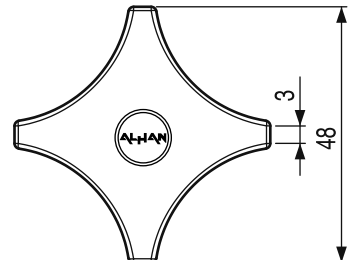
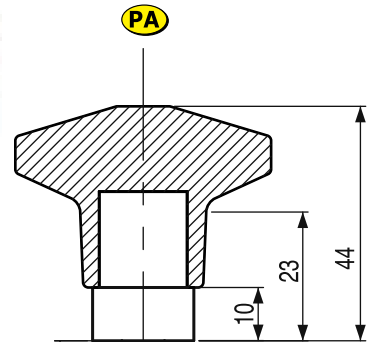

M	AA	A	Malzeme/Material		Kg	Stok Kod Stock Code	75			
M6	19	15	Güçlendirilmiş Polyamid Reinforced Polyamide		0,065	210 E06 215	75			
M6	19	20			0,065	210 E06 220				
M8	19	20			0,065	210 E08 220				
M8	19	25			0,070	210 E08 225				
M8	19	30			0,070	210 E08 230				
M10	19	25			0,080	210 E10 225				
M10	19	30			0,080	210 E10 230				
M12	19	25			0,090	210 E12 225				
M12	19	30			0,090	210 E12 230				
M6	19	15			Siyah Black			0,065	210 E06 015	75
M6	19	20						0,065	210 E06 020	
M8	19	20						0,070	210 E08 020	
M8	19	25	0,070	210 E08 025						
M8	19	30	0,070	210 E08 030						
M10	19	25	0,080	210 E10 025						
M10	19	30	0,080	210 E10 030						
M12	19	25	0,090	210 E12 025						
M12	19	30	0,090	210 E12 030						

SS Renk seçenekleri bulunur./On request by changable colour.
*Özel üretim yapılır./On request special production is available.

KONSOL GÖVDESİ (KÜÇÜK BOY)/ADJUSTABLE BRACKETS

M PA



FT(N)	Kg	Stok Kodu Stock Code	
1000	0,110	210 410 200	120

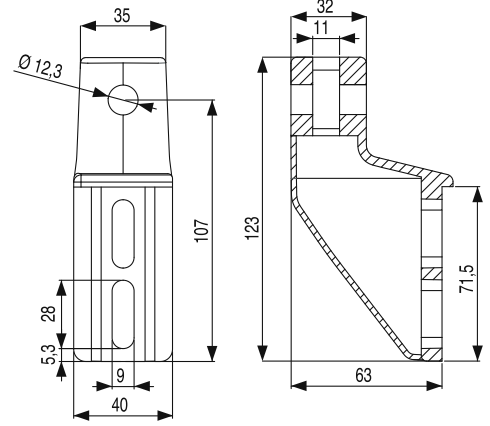

KONSOL GÖVDESİ (ORTA BOY)/ADJUSTABLE BRACKETS

M PA

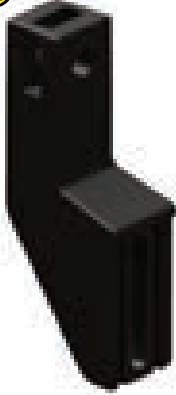

FT(N)	Kg	Stok Kodu Stock Code	
2000	0,120	210 010 200	100

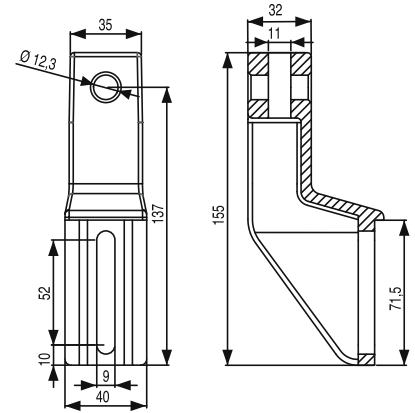

KONSOL GÖVDESİ (BÜYÜK BOY)/ADJUSTABLE BRACKETS

M PA

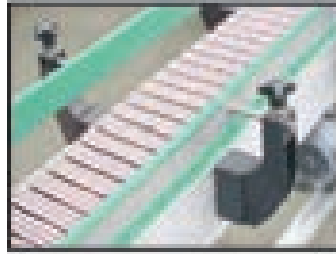

FT(N)	Kg	Stok Kodu Stock Code	
3000	0,295	210 010 201	40

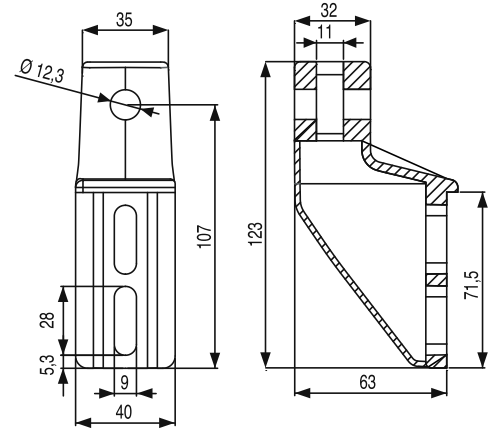

KONSOL GÖVDE TAKIMI (KÜÇÜK)/ADJUSTABLE BRACKETS

M PA SS

Soy.
B8, B9, B10
K1, K2

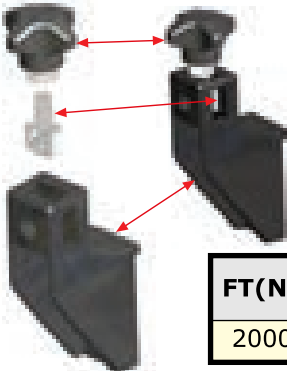

FT(N)	FM(N)	Kg	Stok Kod Stock Code	
2000	4000	0,210	210 110 100	100

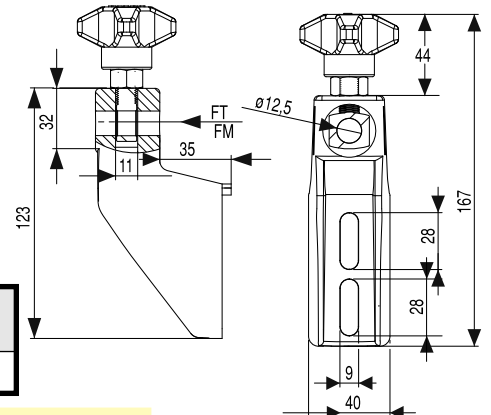

*Özel üretim yapılır./On request special production is available.

KONSOL GÖVDE TAKIMI (ORTA)/ADJUSTABLE BRACKETS

M PA SS



DF	FT(N)	FM(N)	Kg	Stok Kod Stock Code	
12,5	2000	4000	0,215	210 110 200	80

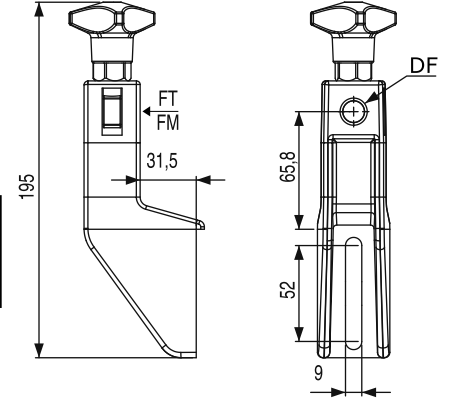

KONSOL GÖVDE TAKIMI (BÜYÜK)/ADJUSTABLE BRACKETS

M PA SS



DF	FT(N)	FM(N)	Kg	Stok Kod Stock Code	
12,5	2000	4000	0,390	210 110 300	30

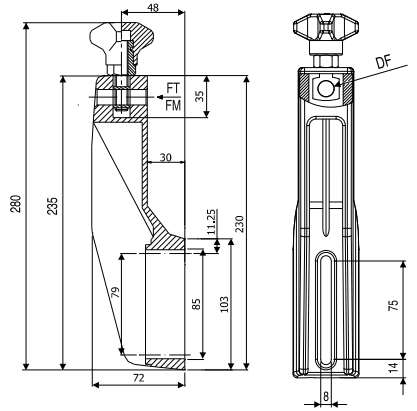

KONSOL TAM TAKIM (ORTA BOY)/ADJUSTABLE BRACKETS

M PA

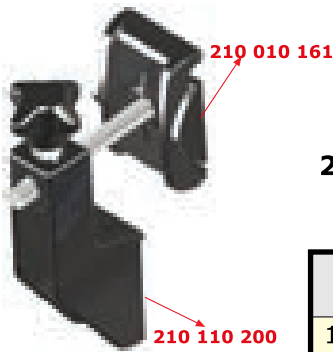

$$210 100 200 = 210 110 200 + 210 010 161$$

DF	FT(N)	FM(N)	Kg	Stok Kod Stock Code	
12,5	2000	4000	0,410	210 100 200	50

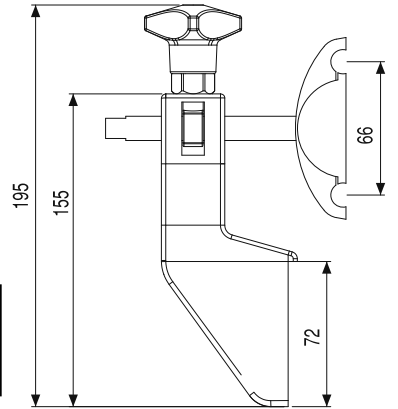

KONSOL TAM TAKIM (BÜYÜK BOY)/ADJUSTABLE BRACKETS

M PA



$$210 100 300 = 210 110 300 + 210 010 161$$

FT(N)	Kg	Stok Kodu Stock Code	
2000	0,585	210 100 300	20

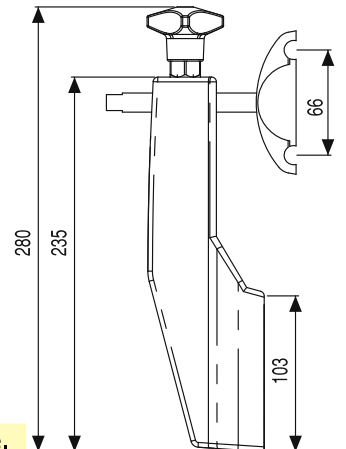

*Özel üretim yapılır./On request special production is available.

KONSOL TABANI/SUPPORT SPACER

M PA

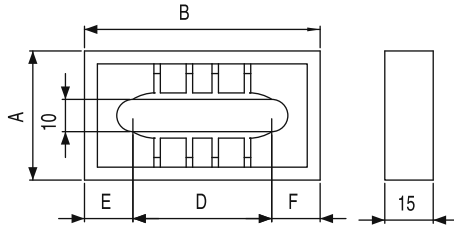

**KULLANILAN KONSOLLAR
FOR ADJUSTABLE BRACKETS**

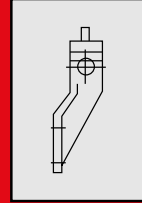

210 IKU 200
210 IDT 200
210 110 200
210 110 400
210 IKG 301

A	B	D	E	F	Kg	Stok Kod Stock Code	
50	102	76	15	10	0,045	210 410 300	100
40	73	43	15	15	0,030	210 410 100	100

DÖNÜŞLÜ KONSOL GÖVDESİ (ORTA BOY)/ADJUSTABLE BRACKETS

M PA



LA	FT(N)	Kg	Stok Kod Stock Code	
9	6000	0,18	210 IDT 200	100

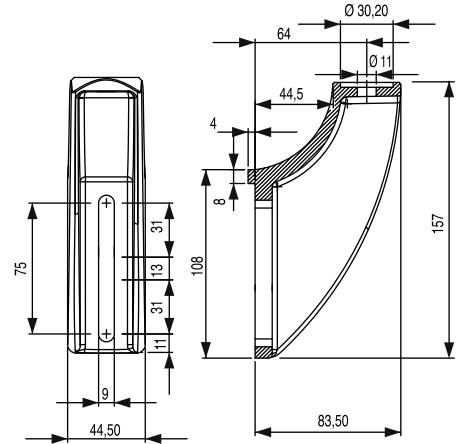

DÖNÜŞ KONSOL BAŞLIĞI/HEADS TYPE 2

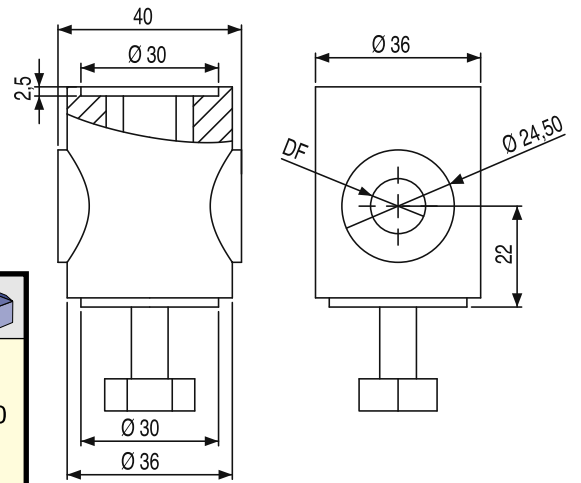

DF	M	Kg	Stok Kod Stock Code	
12,5	Dış Bölüm Güçlendirilmiş Polyamid İç Bölüm Çinko Kaplama Çelik	0,08	210 ICB SLU	100
14,5	Reinforced Polyamide Eyebolt and Fastener in	0,08	210 ICB SLV	
16,5	Stainless Steel	0,08	210 ICB SLY	

*Özel üretim yapılır./On request special production is available.

BAŞLIK 4 TİPİ/HEADS TYPE 4

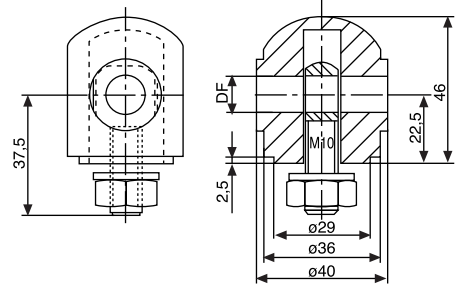
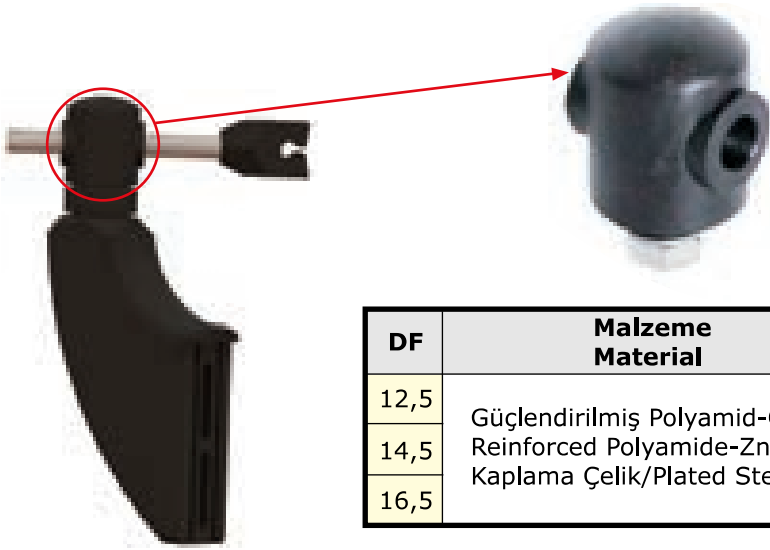

DF	Malzeme Material	Kg	Stok Kod Stock Code	
12,5	Güçlendirilmiş Polyamid-Çinko	0,08	800 120 101	25
14,5	Reinforced Polyamide-Zn	0,08	800 120 102	25
16,5	Kaplama Çelik/Plated Steel	0,08	800 120 103	25

BAŞLIK 5 TİPİ/HEADS TYPE 5

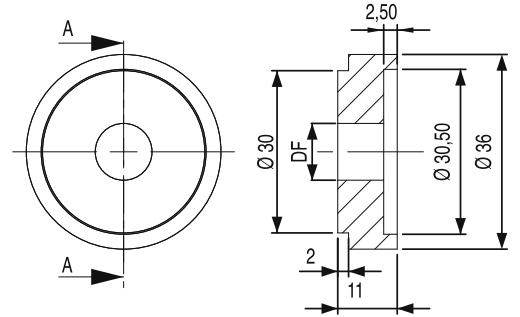
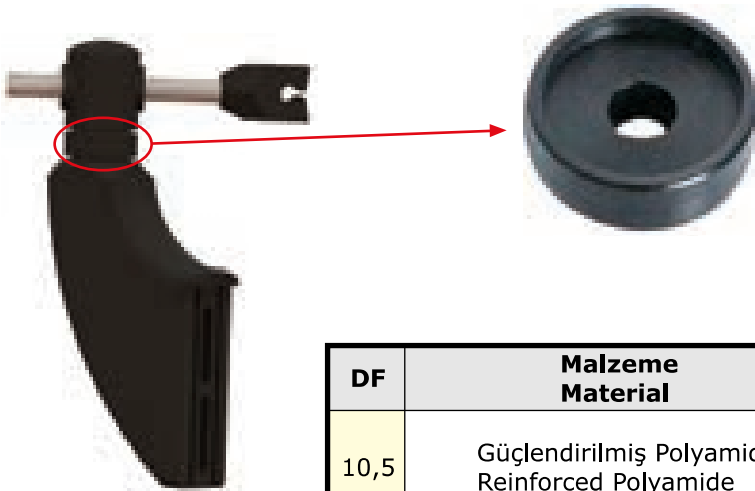

DF	Malzeme Material	Kg	Stok Kod Stock Code	
10,5	Güçlendirilmiş Polyamid Reinforced Polyamide	0,01	800 120 085	200



*Özel üretim yapılır./On request special production is available.

252 BAKALİT KAPAK KOLU/HANDLES

M Bakalit/Bakelite



A	B	C	D	M	Renk Colour	Kg	Stok Kode Stock Code	
109	131	32	-	M6	Siyah/Black	0,095	252 000 010	100
137	170	30,5	-	M8	Siyah/Black	0,145	252 000 020	50

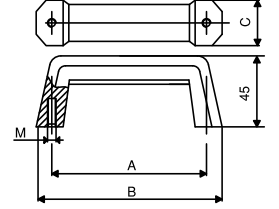

252 PLASTİK KAPAK KOLU SCA MODELİ/HANDLES

M PA



A	B	C	D	E	Renk Colour	Kg	Stok Kod Stock Code	
116	138,5	30	6,5	40	Siyah/Black	0,04	252 610 PA6	100
136	160	29	8,5	42	Siyah/Black	0,055	252 620 PA6	75
116	138,5	30	6,5	40	Turuncu/Orange	0,04	252 611 PA6	100
136	160	29	8,5	42	Turuncu/Orange	0,055	252 621 PA6	75

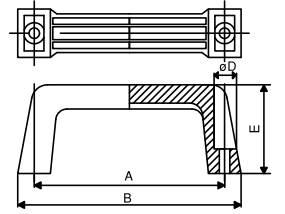

252 PLASTİK KAPAK KOLU SCH MODELİ/HANDLES

M PA



A	B	C	D	E	Renk Colour	Kg	Stok Kod Stock Code	
117,5	137,5	24	7	41	Siyah/Black	0,05	252 710 PA6	100
135	165	28	8,5	47	Siyah/Black	0,09	252 810 PA6	75
116	137,5	24	7	41	Turuncu/Orange	0,05	252 711 PA6	100
135	165	28	8,5	47	Turuncu/Orange	0,09	252 811 PA6	75

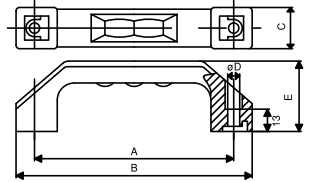

BORULU KAPAK KOLU (KENAR PLASTİĞİ)/HANDLES

M PA



A	B	C	D	Stok Kod Stock Code	
52	32	9	20	215 UKK PA6	100

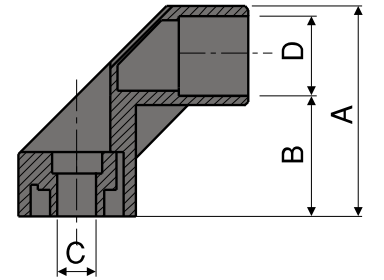

UZUN KAPAK KOLU/HANDLES

**Yeni
New**

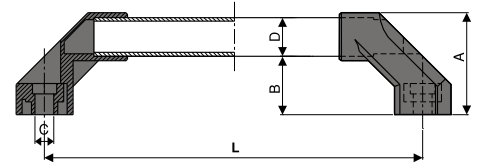

A	B	C	D	L	M	Stok Kode Stock Code		
55	32	9	20	200	PA	215 UKK 200	50	AL
55	32	9	20	300		215 UKK 300		
55	32	9	20	400		215 UKK 400		
55	32	9	20	500		215 UKK 500		

*Özel üretim yapılır./On request special production is available.

PLASTİK MENTEŞE 49*49 GÖMME SOMUNLU/HINGES

M PA Renk/Colour: Siyah/Black

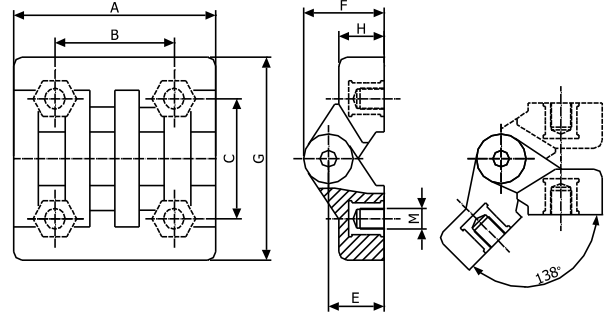
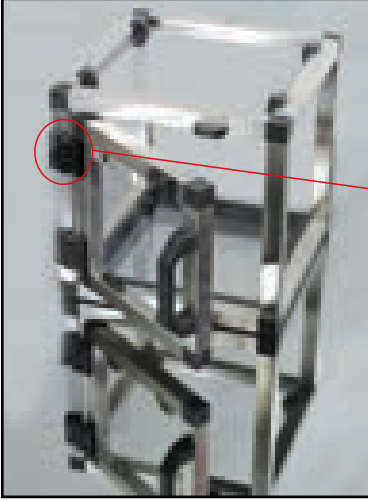

A	B	C	D	E	F	G	M	H	Kg	Stok Kode Stock Code		PIN
49	30	32	10,8	13	20	49	M5	11	0,04	215 000 104	140	SS
49	30	32	10,8	13	20	49	M5	11	0,04	215 001 104	140	ZN



YAPRAK MENTEŞE/LEAF HINGES

Ø5.3 **ZA**
Ø6.3 **PA**

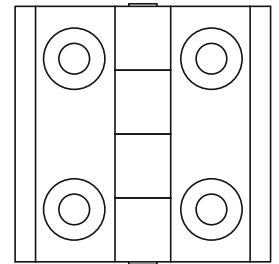
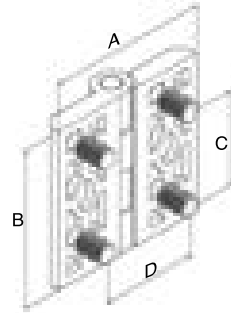
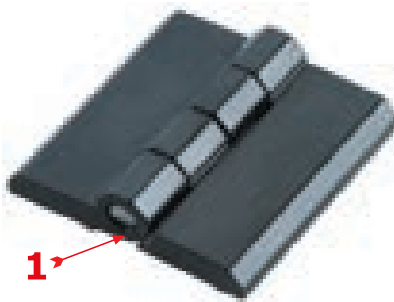
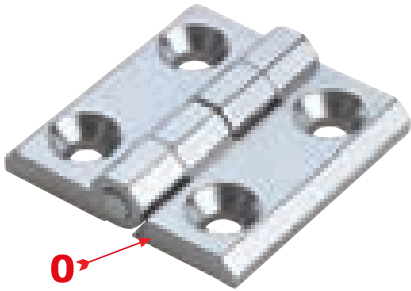

MODELİ **M** **No.**
215 **ZA PA** 040-50-60
140-50-60

215 **ZA** 040
↑ ↑ ↑
215 .. .40

A	B	C	D	M	Stok Kode Stock Code		PIN
40	40	25	25	ZA PA	215 .. .40	100	St37
50	50	30	30		215 .. .50		
60	60	36	36		215 .. .60		

*Özel üretim yapılır./On request special production is available.

PLASTİK MENTEŞE 49*49 VİDALI/HINGES

M PA Renk/Colour: Siyah/Black

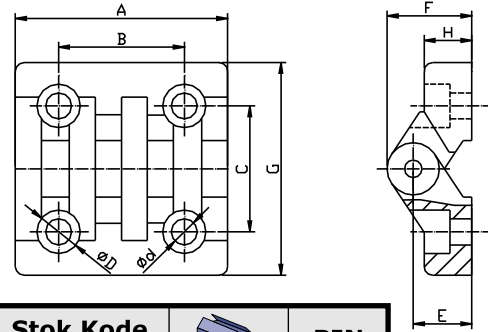

A	C	B	D	d	E	F	G	H	Kg	Stok Kode Stock Code		PIN
49	32	30	10	6	13	20	49	11	0,04	215 000 103	140	SS
49	32	30	10	6	13	20	49	11	0,04	215 001 103	140	ZN
49	32	30	10	6	13	20	49	11	0,04	215 002 103	140	SS



★ Asidik ortam için PP (Polipropilen) malzemeden özel üretim bulunmaktadır.
This material highly resistant to chemical agent.

PLASTİK MENTEŞE 49*65/HINGES

M PA Renk/Colour: Siyah/Black

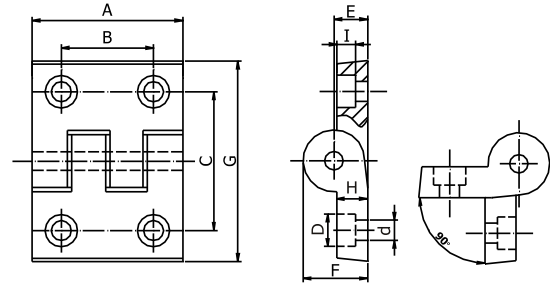

A	B	C	D	E	F	G	H	I	d	Kg	Stok Kode Stock Code		PIN
49	30	45	Ø10,5	11	20	65	10	6	Ø6,5	0,04	215 000 101	100	SS
49	30	45	Ø10,5	11	20	65	10	6	Ø6,5	0,04	215 000 105	100	SS
49	30	45	Ø10,5	11	20	65	10	6	Ø6,5	0,04	215 001 101	100	ZN



★ Asidik ortam için PP (Polipropilen) malzemeden özel üretim bulunmaktadır.
This material highly resistant to chemical agent.

PLASTİK MENTEŞE 78*100/HINGES

M PA Renk/Colour: Siyah/Black

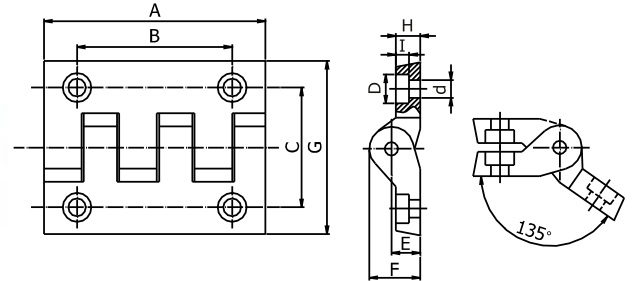

A	B	C	D	E	F	G	H	I	d	Kg	Stok Kode Stock Code		PIN
100	72	54	Ø13	13	23	78	11,5	6	Ø8	0,10	215 000 102	40	SS
100	72	54	Ø13	13	23	78	11,5	6	Ø8	0,10	215 000 106	40	SS
100	72	54	Ø13	13	23	78	11,5	6	Ø8	0,10	215 001 102	40	ZN



★ Asidik ortam için PP (Polipropilen) malzemeden özel üretim bulunmaktadır.
This material highly resistant to chemical agent.

*Özel üretim yapılır./On request special production is available.

DİŞİ SIKMA KOLU/ADJUSTABLE HANDLE

Zamak Metal Döküm (Çinko "Zn", Alüminyum "Al", Bakır "Cu" Alaşımı)
Die Cast Zamak Lever Body (Zinc, Aluminium, Copper, Alloy)
Yüzey/Surface: Pürüzsüz Epoksi Toz Boya
Smooth, Epoxy Powder Painted Finish.
Sabitleme Vidası/Fixing Screw: Siyah Okside Edilmiş Vida
Black Oxide Treated Screw With Socket Head.
Yay/Spring: Çinko Kaplanmış Çelik
Zinc Plated Steel Spring

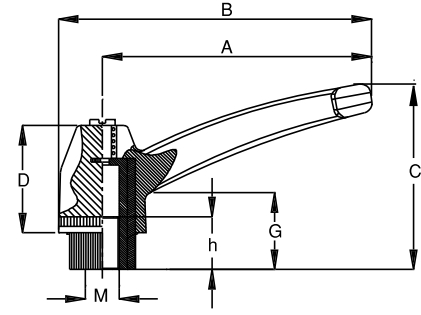

Özel Yüksek Dayanımlı Cam Elyafı Güçlendirilmiş Polyemid
Special High Resistance Glass Fiber Reinforced Polyamide
Dişi Saplama/Main Insert
Çinko Çelik Üzeri Enjeksiyon Kaplama

Tip/Type		M	A	B	C	D	h	G	Kg	Stok Kodu Stock Code	
	ZA	M6	43	50	26	21	8	16	0,035	241 200 006	250
		M8	65	75	45	25	13	21	0,080	241 200 008	100
		M10	82	93	58	31	20	24	0,120	241 200 010	75
		M12	96	112	63	36	21	28	0,245	241 200 012	50
	PA + ZN	M6	46	54	35	21	13	16	0,015	241 400 006	250
		M8	66	77	49	26	17	21	0,025	241 400 008	100
		M10	80	93	57	31	19	24	0,045	241 400 010	75
		M12	109	126	70	40	24	28	0,100	241 400 012	50
	PA + BR	M6	48	53	26	21	13	16	0,015	241 600 006	250
		M8	66	77	40	26	19	21	0,025	241 600 008	100
		M10	80	93	50	31	22	24	0,045	241 600 010	75
		M12	109	126	62	40	24	28	0,100	241 600 012	50

ERKEK SIKMA KOLU/ADJUSTABLE HANDLE

Zamak Metal Döküm (Çinko "Zn", Alüminyum "Al", Bakır "Cu" Alaşımı)
Die Cast Zamak Lever Body (Zinc, Aluminium, Copper, Alloy)
Yüzey/Surface: Pürüzsüz Epoksi Toz Boya
Smooth, Epoxy Powder Painted Finish.
Erkek Saplama/Main Insert: Siyah Okside Edilmiş Isıl İşlemli Çelik
Black Oxide Treated Screw Steel Insert With Male Threaded Stud
Sabitleme Vidası/Fixing Screw: Siyah Okside Edilmiş Vida
Black Oxide Treated Screw With Socket Head.
Yay/Spring: Çinko Kaplanmış Çelik
Zinc Plated Steel Spring

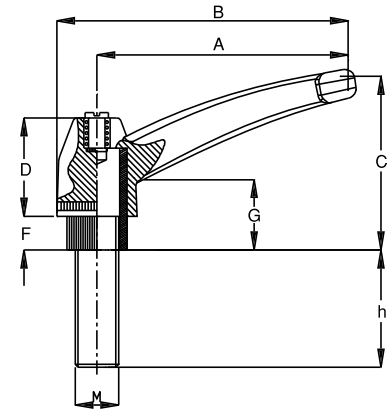
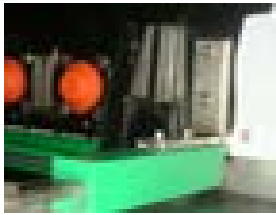



Özel Yüksek Dayanımlı Cam Elyafı Güçlendirilmiş Polyemid
Special High Resistance Glass Fiber Reinforced Polyamide
Dişi Saplama/Main Insert
Çinko Çelik Üzeri Enjeksiyon Kaplama

Tip/Type		M	A	B	C	D	h	F	G	Kg	Stok Kodu Stock Code	
	ZA	M6	43	50	26	21	25	5	16	0,035	241 100 006	250
		M8	65	75	45	25	30	7	21	0,085	241 100 008	100
		M10	82	93	58	31	40	8	24	0,155	241 100 010	75
		M12	96	112	63	36	60	11	28	0,245	241 100 012	50
	PA + ZN	M6	46	54	35	21	25	5	16	0,020	241 300 006	250
		M8	66	77	49	26	30	7	21	0,040	241 300 008	100
		M10	80	93	57	31	40	8	24	0,070	241 300 010	75
		M12	109	126	70	40	60	11	28	0,170	241 300 012	50
	PA + BR	M6	46	54	35	21	25	5	16	0,020	241 500 006	250
		M8	66	77	49	26	30	7	21	0,040	241 500 008	100
		M10	80	93	57	31	40	8	24	0,070	241 500 010	75
		M12	109	126	70	40	60	11	28	0,170	241 500 012	50

*Özel üretim yapılır./On request special production is available.

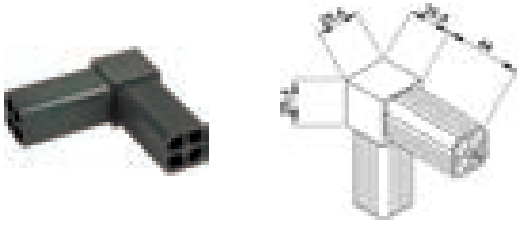
M PA



Tip Type	Kg		Stok Kod Stock Code
A	0,05	50	764 AKS 001

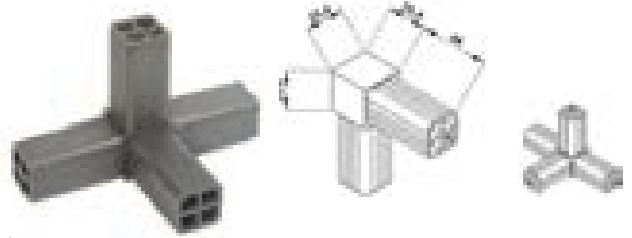
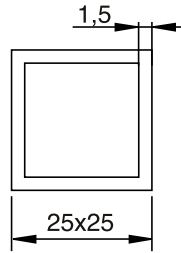

Tip Type	Kg		Stok Kod Stock Code
E	0,09	40	764 EKS 001

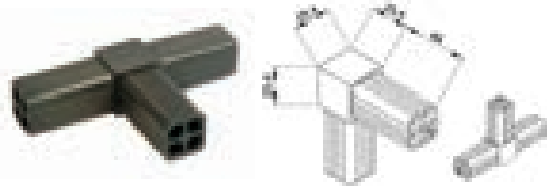

Tip Type	Kg		Stok Kod Stock Code
B	0,07	60	764 BKS 001

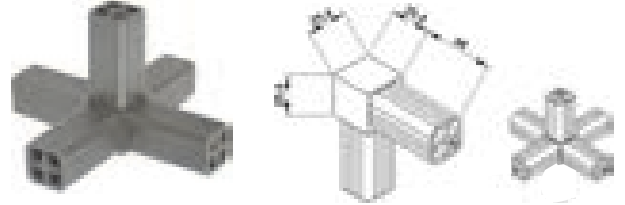

Tip Type	Kg		Stok Kod Stock Code
F	0,11	25	764 FKS 001

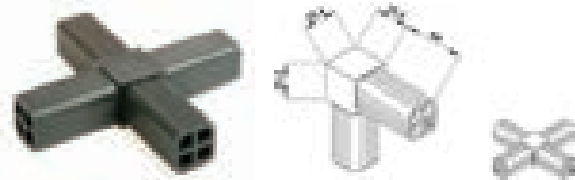

Tip Type	Kg		Stok Kod Stock Code
C	0,09	50	764 CKS 001

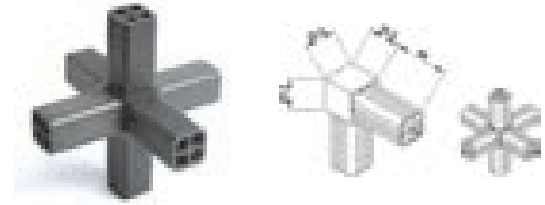

Tip Type	Kg		Stok Kod Stock Code
G	0,13	20	764 GKS 001

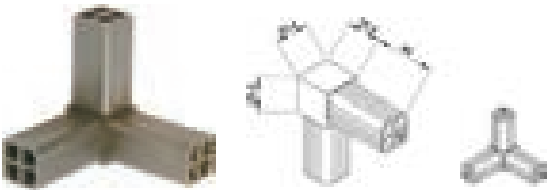

Tip Type	Kg		Stok Kod Stock Code
D	0,07	60	764 DKS 001

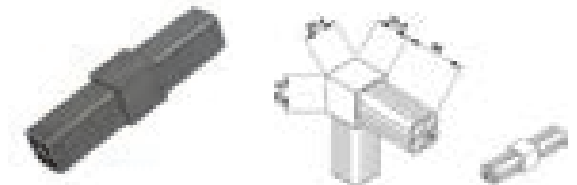

Tip Type	Kg		Stok Kod Stock Code
H	0,05	50	764 HKS 001

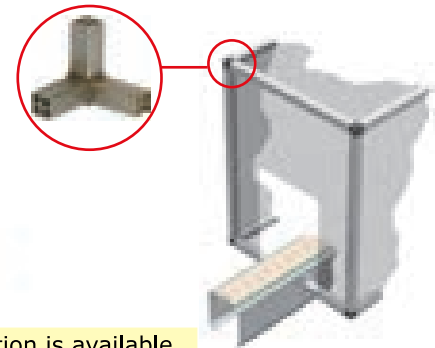
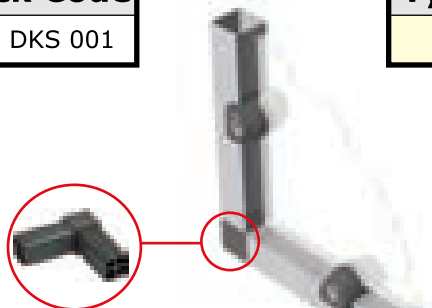
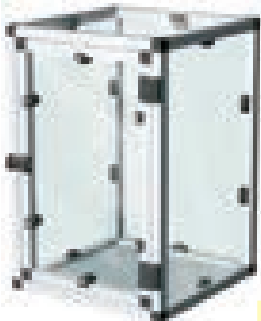

*Özel üretim yapılır./On request special production is available.

FOTSEL AYNA MNGENESİ/PHOTOCELL REFLECTORS

M PA

Yeni
New

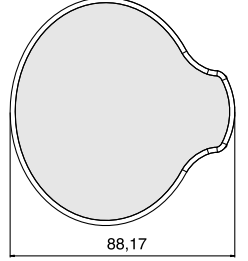
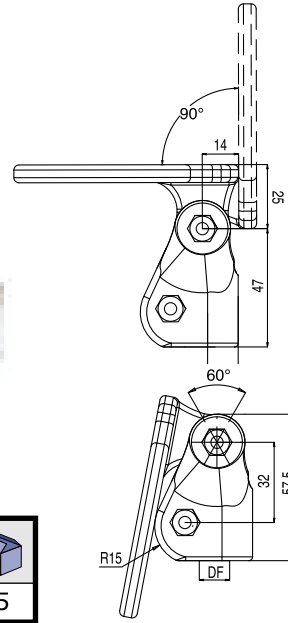
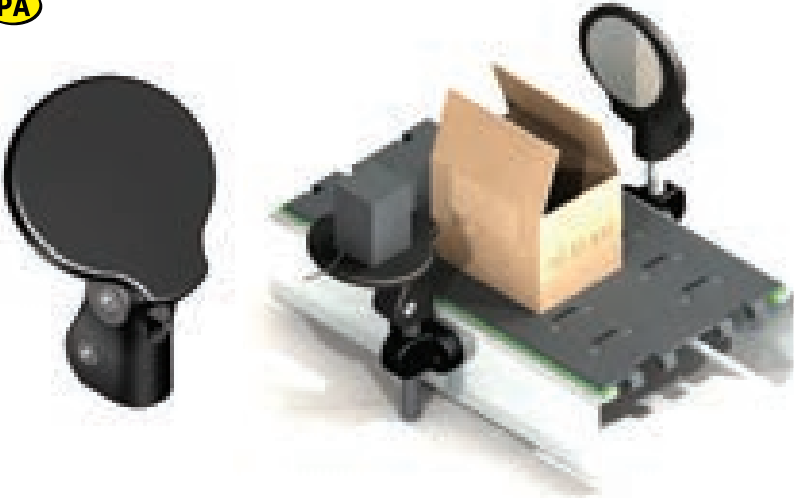

Alan/Area
5240 mm²

DF	Kg	Stok Kod Stock Code	
12	0,1	214 IFM 000	15

FOTSEL ÇAPRAZ TUTUCU MNGENESİ/CROSS BLOCK FOR GUIDES

M PA



Yeni
New

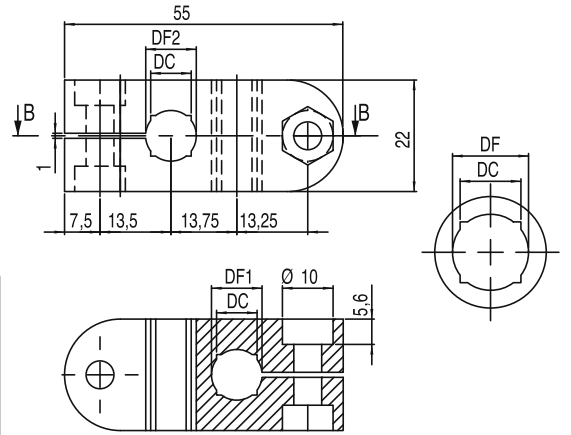

øDF1	øDF2	øDC	Kg	Stok Kod Stock Code	
10	10	8	0,03	214 151 010	120
12	12	10	0,03	214 151 012	120
14	14	12	0,03	214 151 014	120

FOTSEL GÖVDE BAĞLAMA MNGENESİ/PHOTOCELL CROSS BLOCK

M PA

Yeni
New



øDF	øDC	Kg	Stok Kod Stock Code	
10	8	0,03	214 152 010	75
12	10	0,03	214 152 012	75
14	12	0,03	214 152 014	75

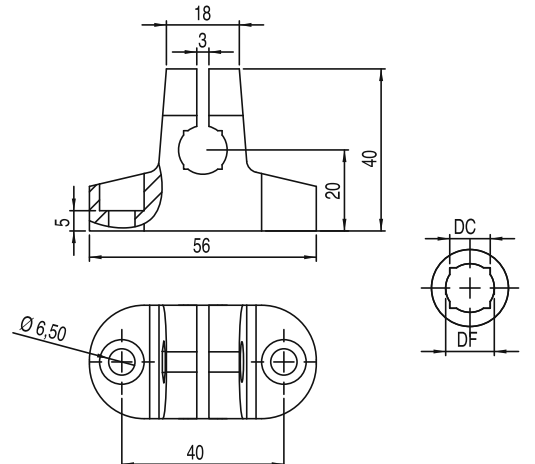

*Özel üretim yapılır./On request special production is available.

FOTSEL TUTMA MENGENE/PHOTOCELL CLAMP



øDF	ØDC	Kg	Stok Kod Stock Code	
10	8	0,02	214 153 010	120
12	10	0,02	214 153 012	120
14	12	0,02	214 153 014	120

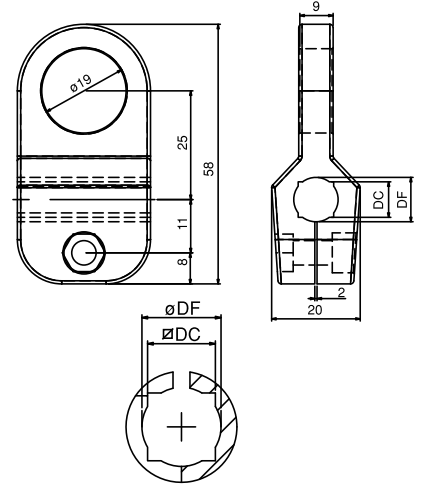

FOTSEL ÇAPRAZ TUTUCU MENGENESİ (AĞIR TİP)/CROSS BLOCK FOR GUIDES (HEAVY DUTY)

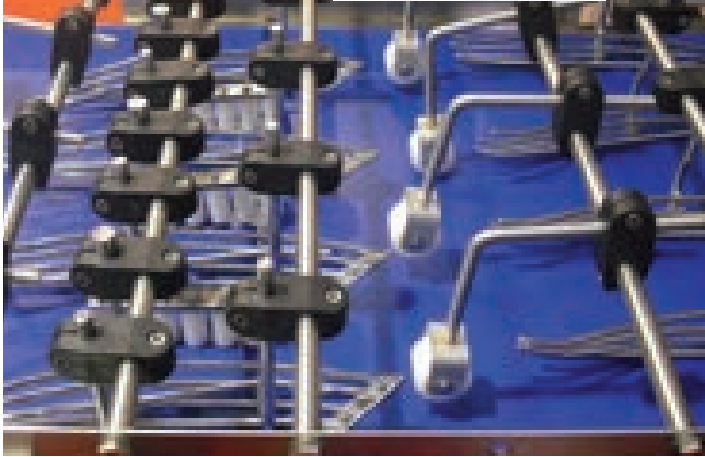
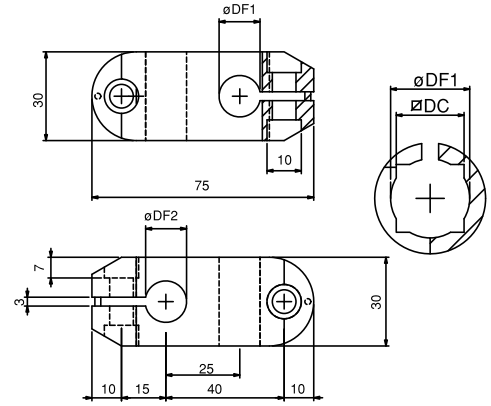

øDF1	øDF2	ØDC	Kg	Stok Kod Stock Code	
14	14	12	0,07	215 251 014	50
16	16	14	0,07	215 251 016	
18	18	16	0,07	215 251 018	
20	20	18	0,07	215 251 020	

FOTSEL GÖVDE BAĞLAMA MENGENESİ (AĞIR TİP)/PHOTOCELL CROSS BLOCK (HEAVY DUTY)

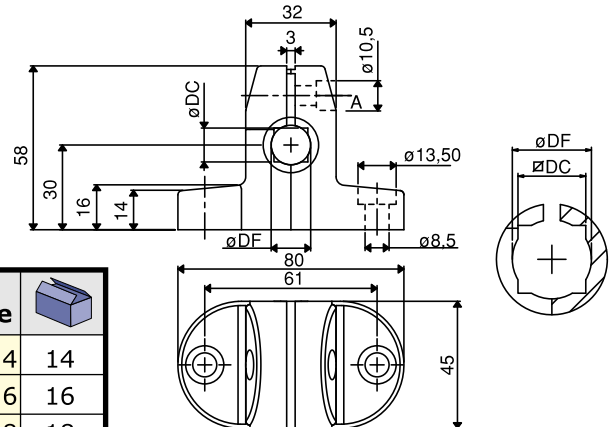

øDF	ØDC	Kg	Stok Kod Stock Code	
14	12	0,09	215 252 014	14
16	14	0,09	215 252 016	16
18	16	0,09	215 252 018	18
20	18	0,09	215 252 020	20

*Özel üretim yapılır./On request special production is available.

FOTOSEL TUTMA MİLİ/PHOTOCELL ROD

M SS AISI 304

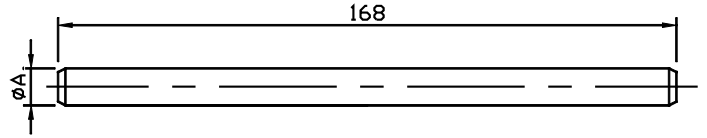

A (mm)	Stok Kod Stock Code	
10	214 154 010	100
12	214 154 012	100

DİŞLİ SABİTLEME KELEPÇESİ (YUVARLAK)/SPLIT COLLARS TYPE (ROUND)

M PA

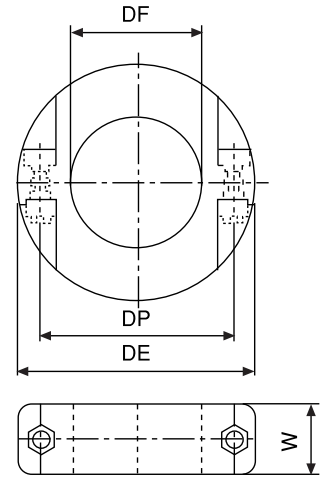
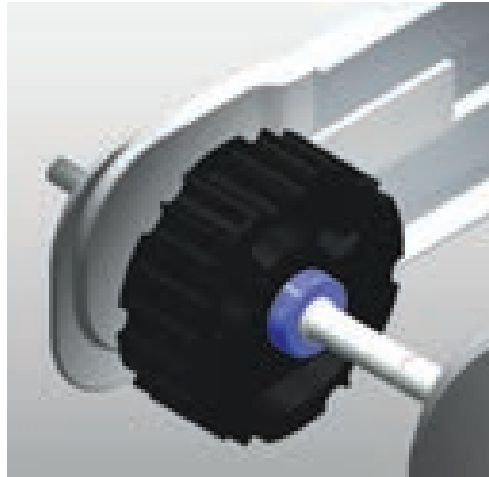

Renk Colour		DF	DE	DP	W	Kg	Stok Kod Stock Code	
Siyah/Black	Güçlendirilmiş Polyamid Paslanmaz Çelik Reinforced Polyamide Fastener in Stainless Steel	20	40	29	14	0,02	○ 800 235 350	100
		25	45	35	14	0,02	○ 800 235 351	100
		30	55	45	16	0,03	○ 800 235 352	60
		35	55	45	16	0,03	○ 800 235 353	60
		40	64	51	18	0,04	○ 800 235 354	40

DİŞLİ SABİTLEME KELEPÇESİ (KARE)/SPLIT COLLARS TYPE (SQUARE)

M PA

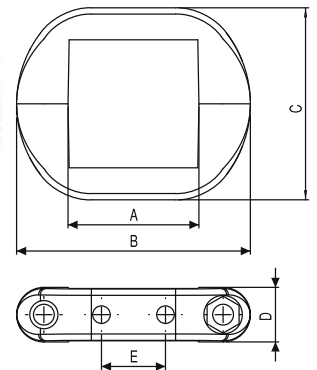
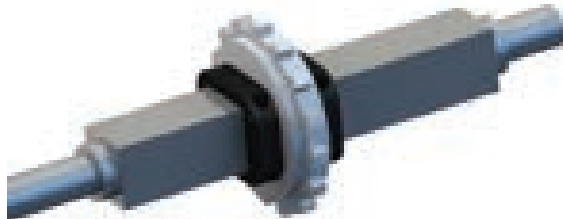
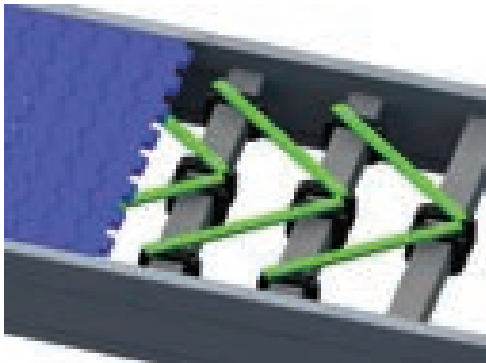

Renk Colour		A	B	C	D	E	Kg	Stok Kod Stock Code	
Siyah/Black	Güçlendirilmiş Polyamid Reinforced Polyamide	40	73	60	17	20	0,04	800 235 040	50
		60	103	91	18	30	0,06	800 235 060	

*Özel üretim yapılır./On request special production is available.

BONCUK MAKARA/ROLLER GUIDE

M ALPOLEN®

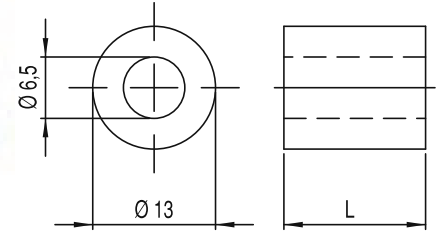
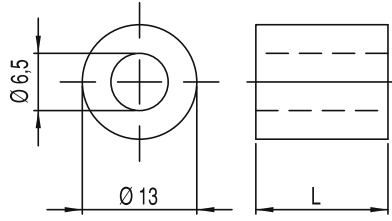

Renk Colour	M	L	Kg	Stok Kod Stock Code	
<input type="checkbox"/>	ALPOLEN®	20	0.017	800 M20 001	200
<input type="checkbox"/>		15	0.012	800 M15 001	

BONCUK MAKARA/ROLLER GUIDE

M **POM**

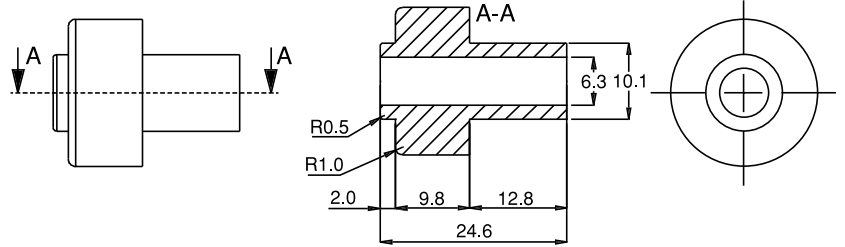

Renk Colour	M	Kg	Stok Kod Stock Code	
<input type="checkbox"/>	POM	0,01	800 010 035	200

Özel üretim yapılır.
On request by manufactured.

BONCUK MAKARA/ROLLER GUIDE

M **POM**

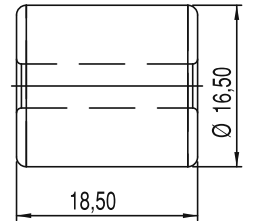
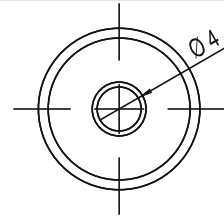
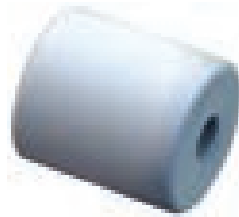
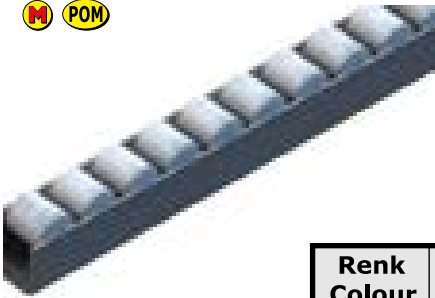

Renk Colour	M	Kg	Stok Kod Stock Code	
<input type="checkbox"/>	POM	0,01	800 185 165	200

Özel üretim yapılır.
On request by manufactured.

BONCUK MAKARA/ROLLER GUIDE

M **POM**

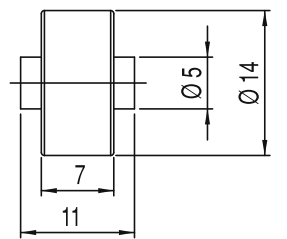
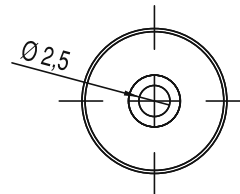

Renk Colour	M	Kg	Stok Kod Stock Code	
<input type="checkbox"/>	POM	0,01	800 711 014	200

Özel üretim yapılır.
On request by manufactured.

*Özel üretim yapılır./On request special production is available.

BONCUK MAKARA TEK SIRALI/ROLLER GUIDE (ONE ROLLER DESING)

M POM



800 030 001

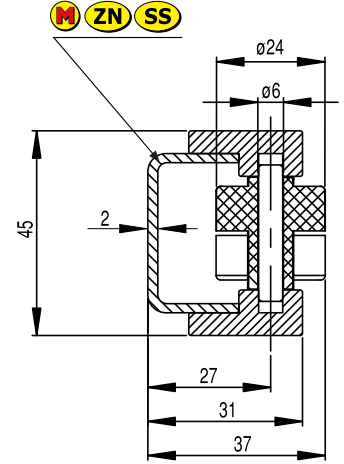
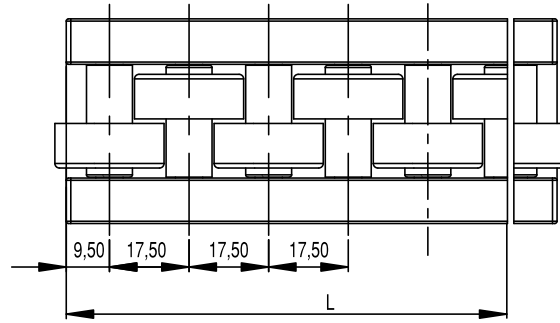

Renk Colour	M	L	Kg	Stok Kod Stock Code	
■	POM	1000	2,41	800 411 652	2
		2000	5,80	800 412 790	
		3000	8,22	800 413 877	

BONCUK MAKARA 2 SIRALI/ROLLER GUIDE (TWO ROLLER DESING)

M POM

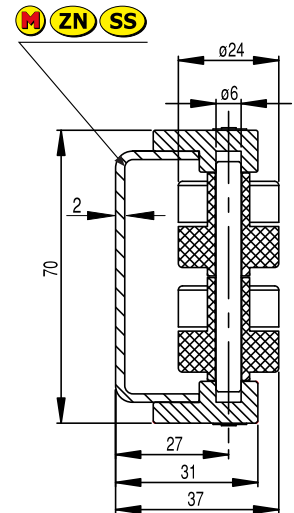
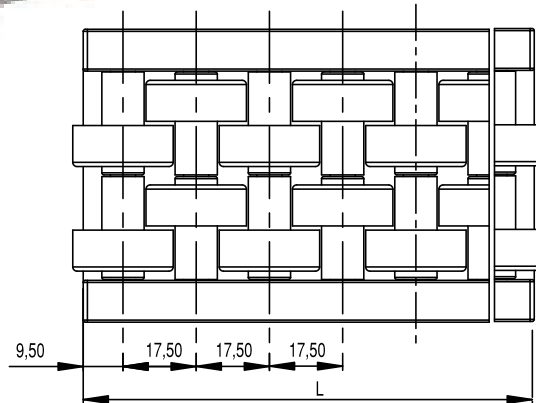

Renk Colour	M	L	Kg	Stok Kod Stock Code	
■	POM	1000	3,50	800 411 654	2
		2000	7,00	800 412 792	
		3000	10,50	800 413 879	

*Özel üretim yapılır./On request special production is available.

BONCUK MAKARA 3 SIRALI/ROLLER GUIDE (THREE ROLLER DESING)

M **POM**

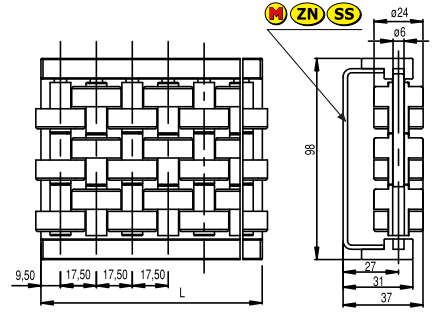
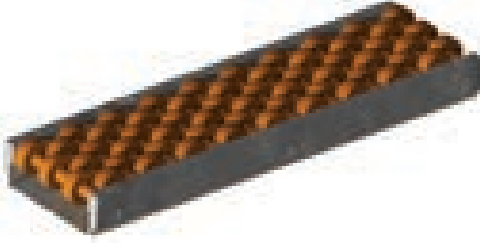

Renk Colour	M	L	Kg	Stok Kod Stock Code	
	Asetal Acetal (POM)	1000	4,60	800 411 657	2
		2000	9,20	800 412 795	
		3000	13,80	800 413 881	

BONCUK MAKARA 4 SIRALI/ROLLER GUIDE (FOUR ROLLER DESING)

M **POM**

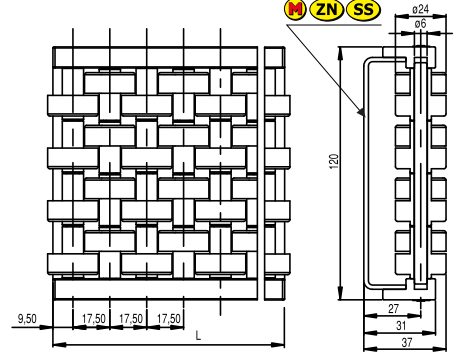
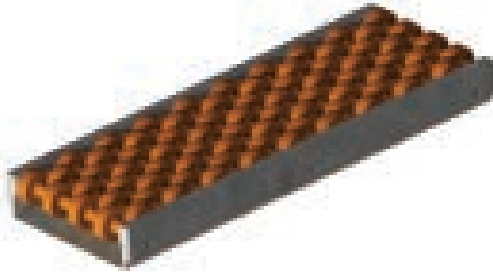

Renk Colour	M	L	Kg	Stok Kod Stock Code	
	Asetal Acetal (POM)	1000	5,75	800 411 660	2
		2000	11,50	800 412 797	
		3000	17,25	800 413 883	

Ø16'LIK MAKARA RULOLU KILAVUZ/ROLLER GUIDE

Yeni New

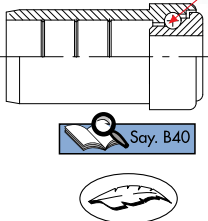
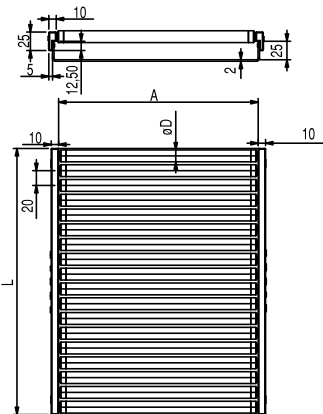
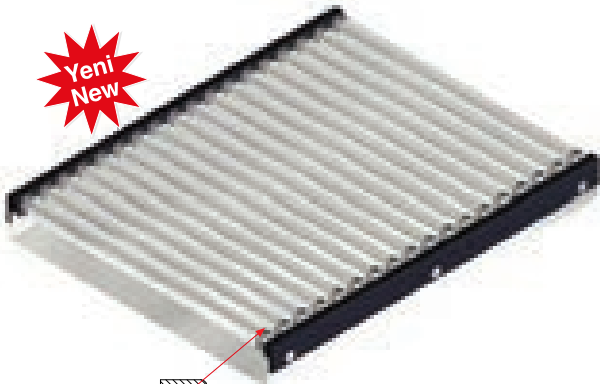

M	øD	A	L	N (Newton)	Stok Kod Stock Code	
	16	100	1005	240	800 411 100	2
	16	200	1005	240	800 411 200	
	16	300	1005	240	800 411 300	

*Özel üretim yapılır./On request special production is available.

BUTE KAFES PA6/BUTE FRAME PA6 - 100'LÜK MAKARA/100 WHEEL

M PA

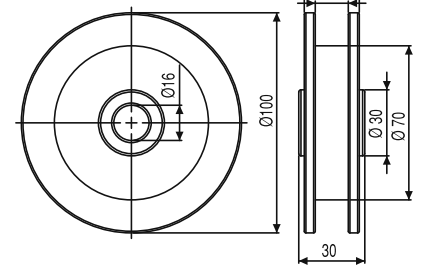
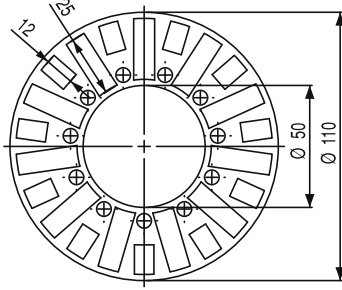
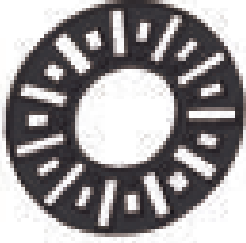

800 BTE PA6

800 100 016

Renk Colour	M	Kg	Stok Kod Stock Code	
Beyaz White	PA	0,030	800 BTE PA6	100
		0,125	800 100 016	30

AÇILIR ÇERÇEVE PROFİLİ/RUNNER PROFILES

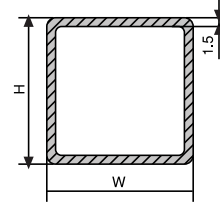
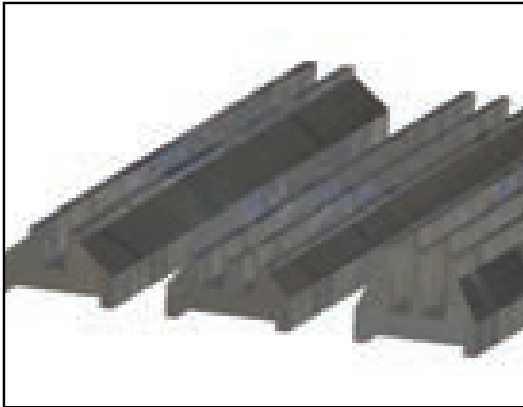

M	H	W	L	Kg	Stok Kod Stock Code
Alaşımlı Alüminyum Anodized Aluminium	25	25	2	1,09	700 ALU 025
Paslanmaz Çelik Stainless Steel	25	25	2	3,21	700 PAS 025

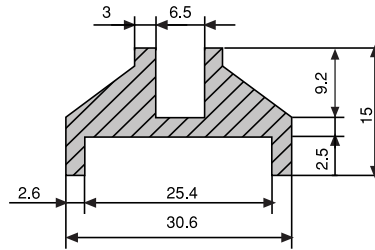

Renk Colour	M	L	Kg	Stok Kod Stock Code
Siyah/Black	Alpolen® 1000 UHMV	2	0,53	700 640 301

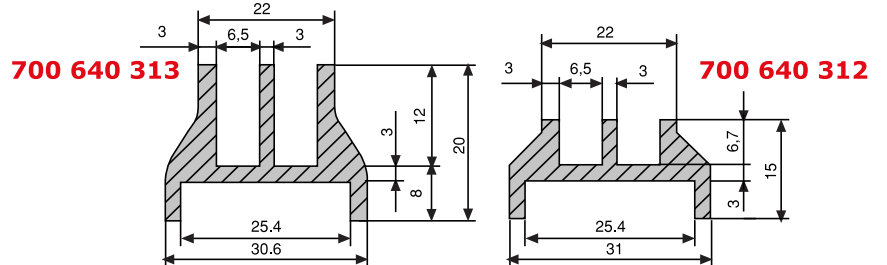

Renk Colour	M	L	Kg	Stok Kod Stock Code
Siyah/Black	Alpolen® 1000 UHMV	2	0,85	700 640 312
		2	0,85	700 640 313

*Özel üretim yapılır./On request special production is available.

KARE PROFİL TAPASI/SQUARE STRIP TUBE

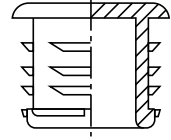
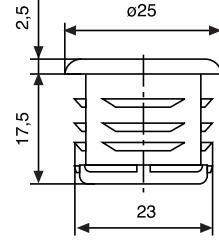
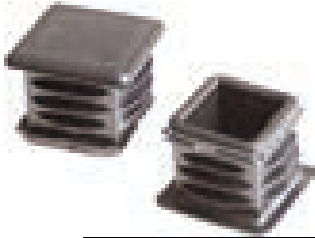

Renk Colour	M	Kg	Stok Kod Stock Code	
Siyah/Black	Polietilen/Polyethylene	0,01	700 460 110	50

YUVARLAK PROFİL TAPASI/ROUND STRIP TUBE

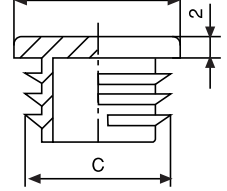
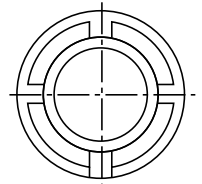

DE	C	Kg	M	Stok Kod Stock Code	
10	8	0,01	Polietilen Siyah Polyethylene Black	700 640 149	400
12	10	0,01		700 640 152	200
14	12	0,01		700 640 154	200
16	14	0,01		700 640 146	200
18	15,5	0,01		700 640 147	200
28	25,8	0,01		700 640 148	200

PANEL KİLİT TUTUCUSU/PANEL LOCKING ATTACHMENT

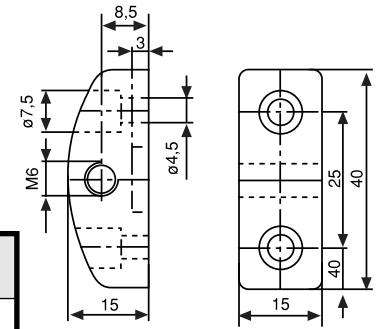

Kg	M	Stok Kod Stock Code	
0,01	Polyamid Siyah Polyamide Black	700 640 060	300

ÇERÇEVE SABİTLEYİCİ/STOP FOR HINGED DOORS

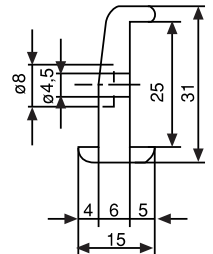
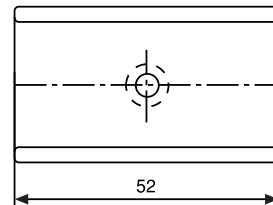

Kg	M	Stok Kod Stock Code	
0,01	Polyamid Siyah Polyamide Black	700 640 501	100

*Özel üretim yapılır./On request special production is available.

240-1 ARA BAĞLANTI TAKOZU/CONNECTING JOINT

M PA

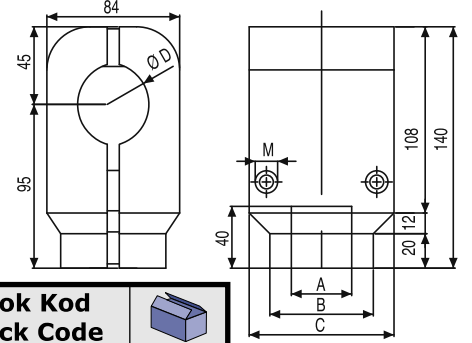
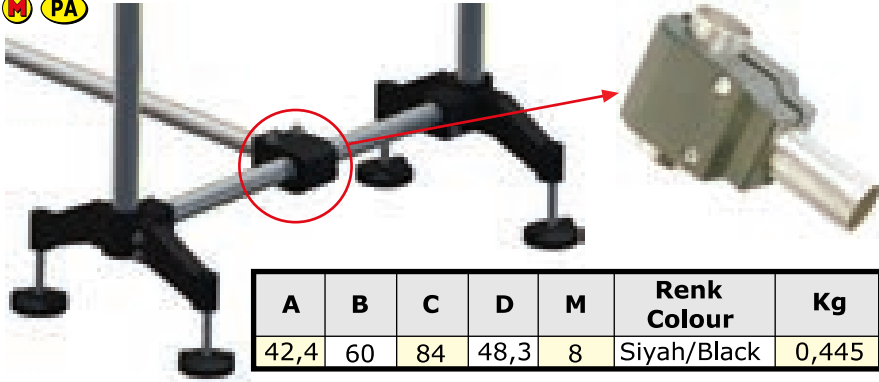

A	B	C	D	M	Renk Colour	Kg	Stok Kod Stock Code	
42,4	60	84	48,3	8	Siyah/Black	0,445	240 021 170	12

240-3 GÖVDE BAĞLANTI TAKOZU/SUPPORT HEADS

M PA

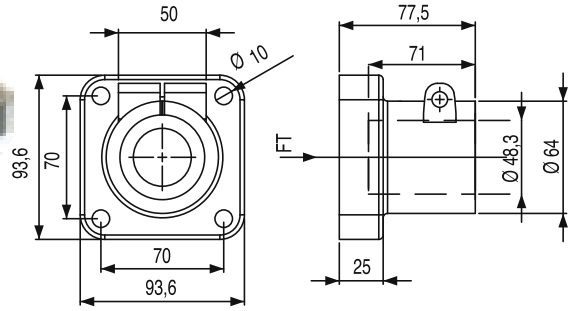

DF(mm)	FT(N)	Kg	Stok Kod Stock Code	
48,3	1500	0,300	240 021 180	16

Max tightening torque 2 kgm

240-4 YAN BAĞLANTI TAKOZU/SIDE MOUNTING TOP BRACKETS

M PA

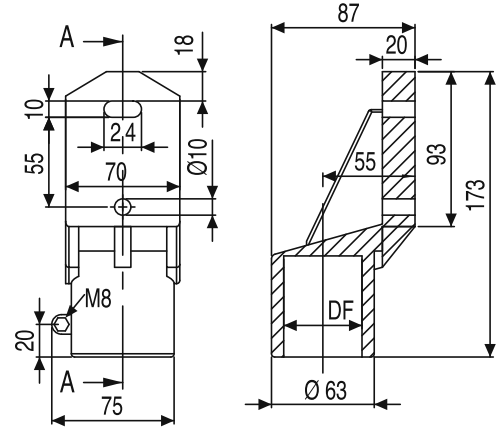
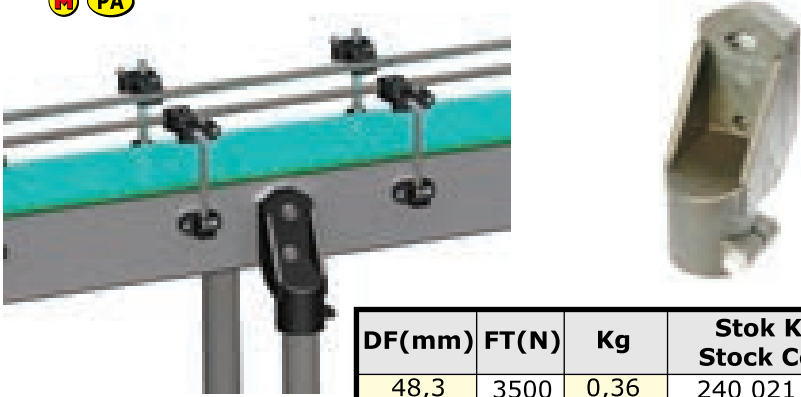

DF(mm)	FT(N)	Kg	Stok Kod Stock Code	
48,3	3500	0,36	240 021 200	14

İKİ YÖNLÜ PROFİL DÖNÜŞ BOYNU/DOUBLE SLIDING SHOE

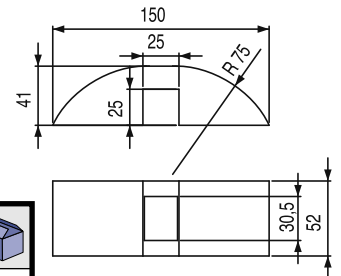

M	Kg	Stok Kodu Stock Code	
Alpolen@UHMW 1000 Yeşil Alpolen@UHMW 1000 Green	0,07	216 100 103	20

*Özel üretim yapılır./On request special production is available.

216 DÖNÜŞ BOYNU POLYAMİD TARAKLI/SLIDING SHOE

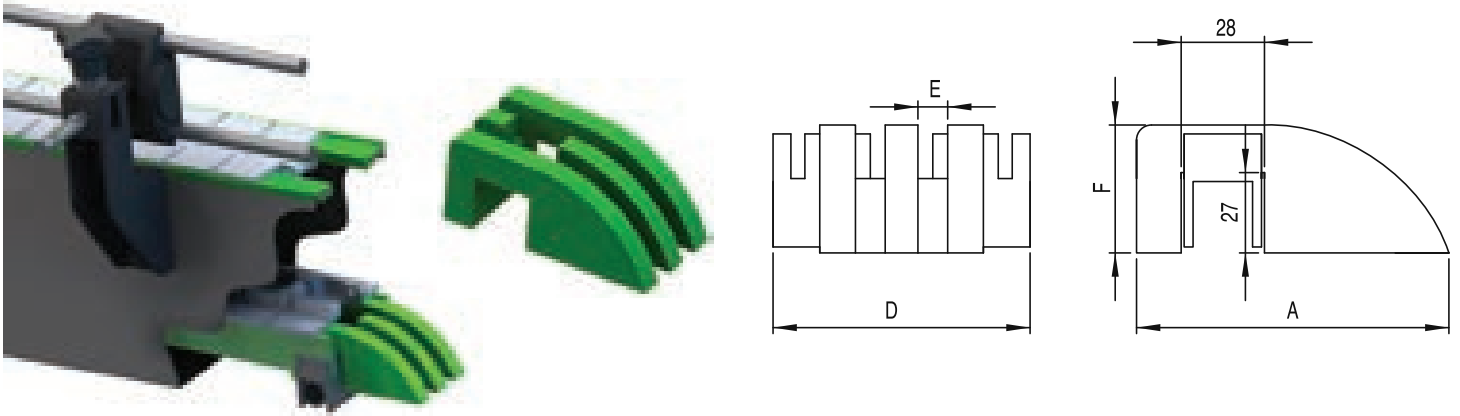

A	B	C	D	E	F	M	Kg	Stok Kod Stock Code	
105	28	27	55	10	43	Güçlendirilmiş Polyamid-Siyah Reinforced Polyamide-Black	0,04	216 100 001	20

216 PROFİL DÖNÜŞ BOYNU/SPACER FOR SERPENTINE

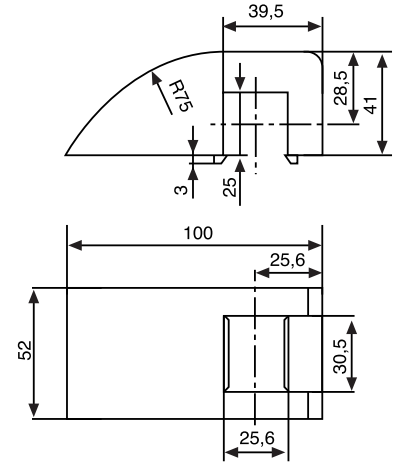
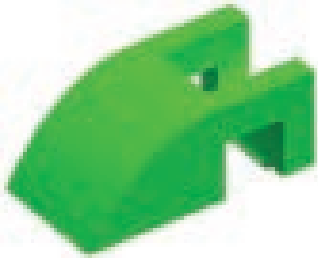

M	Kg	Stok Kod Stock Code	
Alpolen®	0,04	216 100 203	30

216 PROFİL TARAĞI/SPACER FOR SERPENTINE

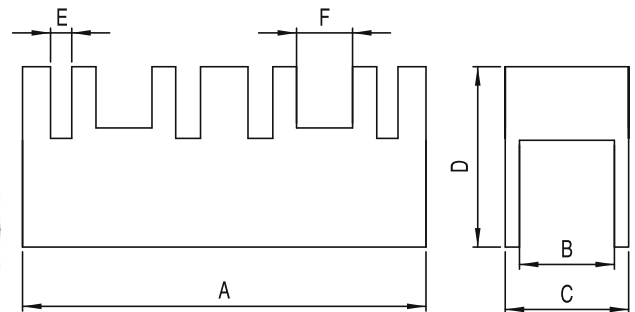
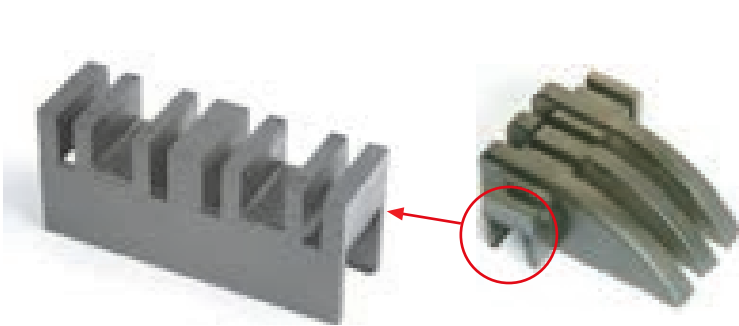

A	B	C	D	E	F	M	Kg	Stok Kod Stock Code	
85	20	26	38	4,7	11,8	Güçlendirilmiş Polyamid-Siyah Reinforced Polyamide-Black	0,04	216 100 002	30

*Özel üretim yapılır./On request special production is available.

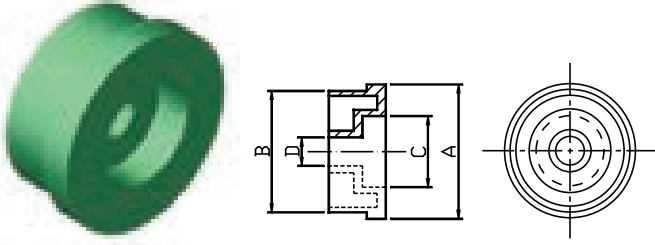

RULO RULMAN YATAKLARI/ROLLERS (FOR BEARINGS)
261-1 AVARA RULO BAŞLIĞI/IDLE ROLLERS

A	B	C	D	Stok Kodu Stock Code	
30	20	15	6	261 302 015	100
35	31	26	10	261 353 126	
48	43,5	19	7	261 484 319	
48	43,5	22	7	261 484 322	
48	43,5	26	10	261 484 326	
48	43,5	19	7	261 434 320*	
50	45	32	15	261 504 532	

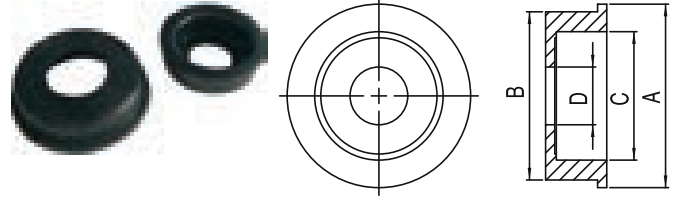
*: Çift Rulmanlı/Two Bearings

261-1 AVARA RULO BAŞLIĞI/IDLE ROLLERS

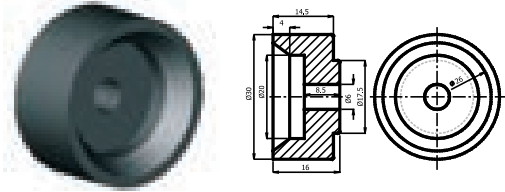
A	B	C	D	Kg	Stok Kodu Stock Code	
60	55	42	20	0,248	261 605 542	100
60	55	47	20	0,248	261 605 547	
75	66	47	20	0,370	261 756 647	
75	70	47	20	0,370	261 757 047	
75	70	35	17	0,370	261 757 035	
88	83	47	20	0,372	261 888 347	
90	85	47	20	0,378	261 908 547	

261-1/30'LUK

Kg	Stok Kod Stock Code	
0,016	261 302 015	400

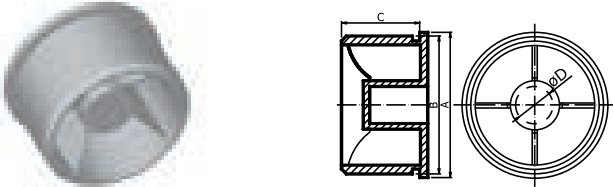
261-5 BURÇLU RULO BAŞLIĞI/BUSHING ROLLERS HEADS

A	B	C	D	Renk/Colour	Kg	Stok Kod Stock Code	
90	85	47	20	Natural	0,125	261 908 517	25

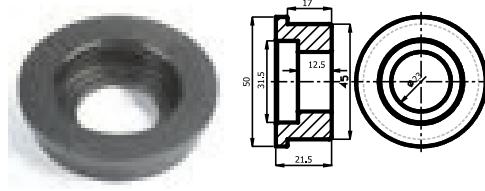
261-1/45'LİKAVARA RULO BAŞLIĞI/IDLE ROLLERS

Kg	Stok Kod Stock Code	
0,025	261 504 532	150

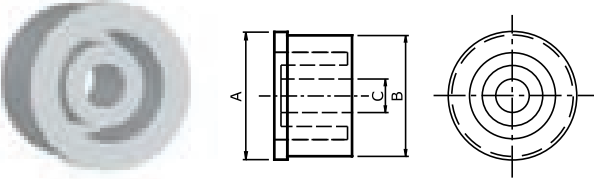
271 AVARA RULO BAŞLIĞI/IDLE ROLLERS

A	B	C	Kg	Stok Kod Stock Code	
43	40	14	0,025	271 434 014	120
43	40	16	0,025	271 434 016	
50	45	14	0,035	271 504 514	

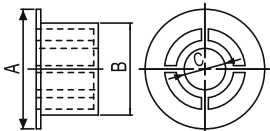
271 AVARA FLANŞ/IDLE ROLLERS

A	B	C	Kg	Stok Kod Stock Code	
52	40	14	0,025	271 524 014	175
52	40	16	0,025	271 524 016	
52	40	18	0,025	271 524 018	
52	40	20	0,025	271 524 020	
52	43	16	0,020	271 524 316	
52	43	20	0,020	271 524 320	

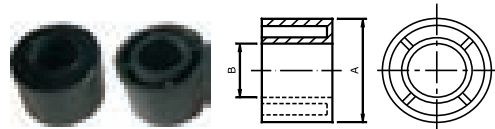
271 AVARA RULO/IDLE ROLLERS

A	B	Kg	Stok Kod Stock Code	
40	20	0,015	271 004 020	100
40	18	0,015	271 004 018	100
40	16	0,015	271 004 016	100
40	14	0,015	271 004 014	100

*Özel üretim yapılır./On request special production is available.

HPL RULMAN YATAKLARI (GERDİRMELİ)/BEARING INSERT



M PA PP

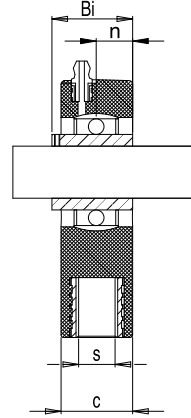
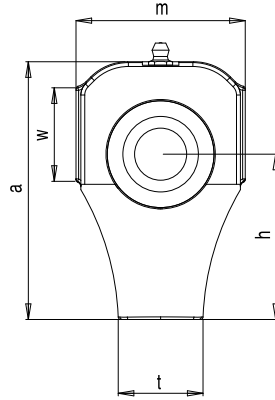

M	Ölçüler/Dimensions (mm)										Kg	+	Stok Kod Stock Code	Kg	-	Stok Kod Stock Code	Yük Kapasitesi Bearing Load Ratings		50
	øEJE	a	c	h	m	s	t	w	B1	n							dyn (N)	st (N)	
PA	ø20	99	27,5	64,5	74	M16	36	47	31	12,7	0,35	+	245 HPL 204	0,19	-	246 HPL 204	7800	5300	50
	ø25	99	27,5	64,5	74	M16	36	47	34	14,3	0,40	+	245 HPL 205	0,21	-	246 HPL 205	8600	6250	40
	ø30	124	34,5	77,5	88	M16	40	63	38,1	15,9	0,55	+	245 HPL 206	0,25	-	246 HPL 206	12000	9000	30
	ø35	124	34,5	77,5	88	M16	40	63	42,9	17,5	0,80	+	245 HPL 207	0,32	-	246 HPL 207	15700	12000	20
	ø40	140	34,5	85	100	M16	40	80	49,2	19	0,90	+	245 HPL 208	0,28	-	246 HPL 208	17900	14300	15
PP	ø20	99	27,5	64,5	74	M16	36	47	31	12,7	0,35	+	243 HPL 204	0,19	-	244 HPL 204	7800	5300	100
	ø25	99	27,5	64,5	74	M16	36	47	34	14,3	0,40	+	243 HPL 205	0,21	-	244 HPL 205	8600	6250	100
	ø30	124	34,5	77,5	88	M16	40	63	38,1	15,9	0,55	+	243 HPL 206	0,25	-	244 HPL 206	12000	9000	100
	ø35	124	34,5	77,5	88	M16	40	63	42,9	17,5	0,80	+	243 HPL 207	0,32	-	244 HPL 207	15700	12000	50
	ø40	140	34,5	85	100	M16	40	80	49,2	19	0,90	+	243 HPL 208	0,28	-	244 HPL 208	17900	14300	50

FBL RULMAN YATAKLARI/OMEGA BEARING INSERT

M PA PP

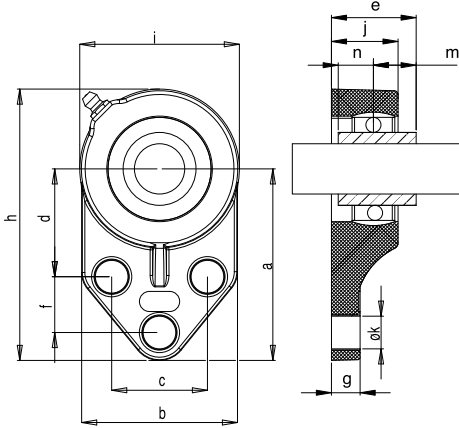

M	Ölçüler/Dimensions (mm)													Metrik Bolt D. (mm)	Kg	+	Stok Kod Stock Code	Kg	-	Stok Kod Stock Code	Yük Kapasitesi Bearing Load Ratings		50	
	øEJE	a	b	c	d	e	f	g	h	i	j	k	m								n	dyn (N)		st (N)
PA	ø20	76,2	62	38	42,9	33,7	22,2	11	108	62	24,5	11	18,3	12,7	M10	0,250	+	245 FBL 204	0,095	-	246 FBL 204	7800	5300	50
	ø25	85,7	63,5	41,3	46	41,2	28,6	11,4	120,7	70	34	11	19,7	14,3	M10	0,300	+	245 FBL 205	0,105	-	246 FBL 205	8600	6250	40
	ø30	96,5	76	47,6	52,4	41,5	31,8	13,3	138	83	32	11	22,2	15,9	M10	0,460	+	245 FBL 206	0,150	-	246 FBL 206	12000	9000	30
	ø35	109,5	89	50,8	60,3	47,1	31,8	16,1	157	95	36,5	13,1	25,4	17,5	M12	0,660	+	245 FBL 207	0,190	-	246 FBL 207	15700	12000	20
PP	ø20	76,2	62	38	42,9	33,7	22,2	11	108	62	24,5	11	18,3	12,7	M10	0,250	+	243 FBL 204	0,095	-	244 FBL 204	7800	5300	100
	ø25	85,7	63,5	41,3	46	41,2	28,6	11,4	120,7	70	34	11	19,7	14,3	M10	0,300	+	243 FBL 205	0,105	-	244 FBL 205	8600	6250	100
	ø30	96,5	76	47,6	52,4	41,5	31,8	13,3	138	83	32	11	22,2	15,9	M10	0,460	+	243 FBL 206	0,150	-	244 FBL 206	12000	9000	100
	ø35	109,5	89	50,8	60,3	47,1	31,8	16,1	157	95	36,5	13,1	25,4	M12	0,660	+	243 FBL 207	0,190	-	244 FBL 207	15700	12000	50	

*Özel üretim yapılır./On request special production is available.

TPL RULMAN YATAKLARI (KIZAK GERDİRMELİ)/BEARING INSERT

M PA PP

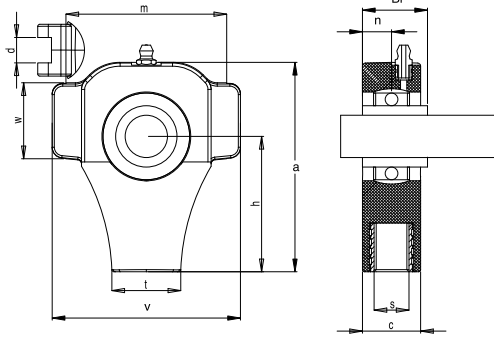

M	Ölçüler/Dimension (mm)												Kg	+	Stok Kod Stock Code	Kg	-	Stok Kod Stock Code	Yük Kapasitesi Bearing Load Ratings		
	øEJE	a	c	d	h	m	s	t	w	v	Bi	n							dyn (N)	st (N)	
PA	ø20	99	27,5	11,5	64	76	M16	33	36	89	31	12,7	0,350	+	245 TPL 204	0,195	-	246 TPL 204	7800	5300	50
	ø25	99	27,5	11,5	64	76	M16	33	36	89	34	14,3	0,400	+	245 TPL 205	0,205	-	246 TPL 205	8600	6250	40
	ø30	123,5	34,5	11,5	76	86,5	M16	34,5	63	100	38,1	15,9	0,550	+	245 TPL 206	0,240	-	246 TPL 206	12000	9000	30
	ø35	123,5	34,5	11,5	76	89	M16	34,5	63	100	42,9	17,5	0,800	+	245 TPL 207	0,330	-	246 TPL 207	15700	12000	20
	ø40	140	34,5	16	85	102	M16	40	80	103	49,2	19	0,950	+	245 TPL 208	0,350	-	246 TPL 208	17900	14300	15
PP	ø20	99	27,5	11,5	64	76	M16	33	36	89	31	12,7	0,350	+	243 TPL 204	0,195	-	244 TPL 204	7800	5300	100
	ø25	99	27,5	11,5	64	76	M16	33	36	89	34	14,3	0,400	+	243 TPL 205	0,205	-	244 TPL 205	8600	6250	100
	ø30	123,5	34,5	11,5	76	86,5	M16	34,5	63	100	38,1	15,9	0,550	+	243 TPL 206	0,240	-	244 TPL 206	12000	9000	100
	ø35	123,5	34,5	11,5	76	89	M16	34,5	63	100	42,9	17,5	0,800	+	243 TPL 207	0,330	-	244 TPL 207	15700	12000	50
	ø40	140	34,5	16	85	102	M16	40	80	103	49,2	19	0,950	+	243 TPL 208	0,350	-	244 TPL 208	17900	14300	50

LFL RULMAN YATAKLARI / BEARING INSERT

M PA PP

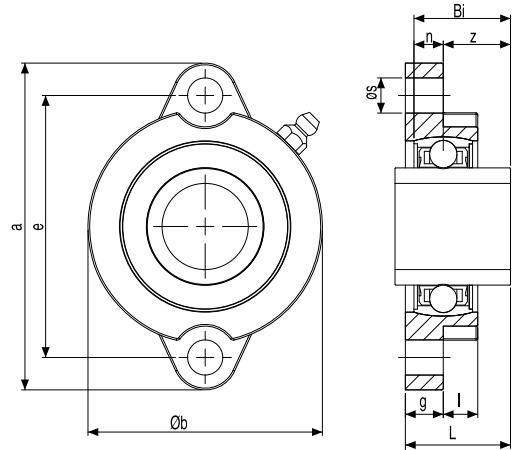
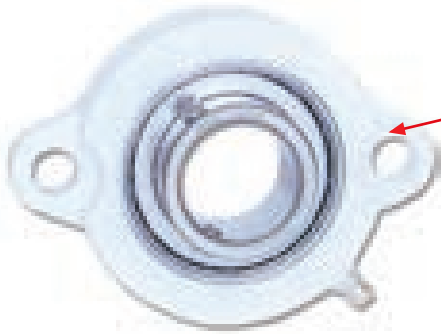

M	Ölçüler/Dimension (mm)											Metrik Bolt D. (mm)	Kg	+	Stok Kod Stock Code	Kg	-	Stok Kod Stock Code	Yük Kapasitesi Bearing Load Ratings		
	øEJE	a	e	g	l	s	b	z	Bi	L	n								dyn (N)	st (N)	
PA	ø20	90	71	11	9	10	63	17,5	24,7	31	7	M8	0,28	+	245 LFL 204	0,12	-	246 LFL 204	7800	5300	50
	ø25	95	76	11	10	10	69	19,5	27	31	7,5	M8	0,36	+	245 LFL 205	0,17	-	246 LFL 205	8600	6250	40
	ø30	113	90	12	11	11,5	79	22,5	30,3	35,7	8	M10	0,56	+	245 LFL 206	0,26	-	246 LFL 206	12000	9000	30
	ø35	122	100	13	11	11,5	89	24,5	32,9	38,9	8,5	M10	0,79	+	245 LFL 207	0,31	-	246 LFL 207	15700	12000	20
PP	ø20	90	71	11	9	10	63	17,5	24,7	31	7	M8	0,28	+	243 LFL 204	0,12	-	244 LFL 204	7800	5300	100
	ø25	95	76	11	10	10	69	19,5	27	31	7,5	M8	0,36	+	243 LFL 205	0,17	-	244 LFL 205	8600	6250	100
	ø30	113	90	12	11	11,5	79	22,5	30,3	35,7	8	M10	0,56	+	243 LFL 206	0,26	-	244 LFL 206	12000	9000	100
	ø35	122	100	13	11	11,5	89	24,5	32,9	38,9	8,5	M10	0,79	+	243 LFL 207	0,31	-	244 LFL 207	15700	12000	50

*Özel üretim yapılır./On request special production is available.

PPL RULMAN YATAKLARI (KÖPRÜ)/OMEGA BEARING INSERT

M PA PP

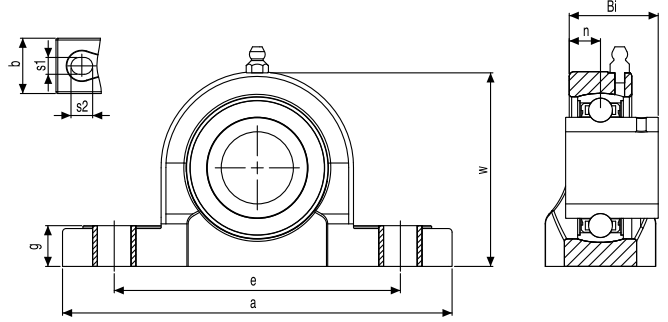
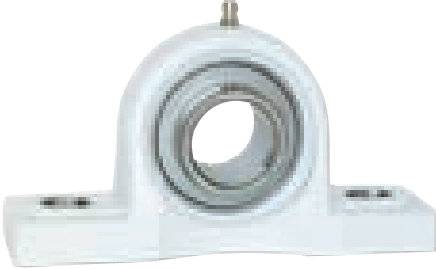

M	Ölçüler/Dimension (mm)											Metrik Bolt D. (mm)	Kg	+	Stok Kod Stock Code	Kg	-	Stok Kod Stock Code	Yük Kapasitesi Bearing Load Ratings		50
	øEJE	h	a	e	b	s1	s2	g	w	Bi	n								dyn (N)	st (N)	
PA	ø20	31,5	128	95	38	11	15	14,2	64	65,5	12,7	M10	0,29	+	245 PPL 204	0,13	-	246 PPL 204	7800	5300	50
	ø25	36,5	140,5	104,5	38	11	15	15	71	71	14,3	M10	0,34	+	245 PPL 205	0,15	-	246 PPL 205	8600	6250	40
	ø30	41	163	119	46	14	17,5	17,5	82,5	84	15,9	M12	0,54	+	245 PPL 206	0,24	-	246 PPL 206	12000	9000	30
	ø35	48	168,5	127	48	14	17,5	19	94,5	94,5	17,5	M12	0,78	+	245 PPL 207	0,30	-	246 PPL 207	15700	12000	20
	ø40	49,2	184	136,5	54	14	18	19,5	99	99	19	M12	0,97	+	245 PPL 208	0,35	-	246 PPL 208	17900	14300	15
PP	ø20	31,5	128	95	38	11	15	14,2	64	65,5	12,7	M10	0,29	+	243 PPL 204	0,13	-	244 PPL 204	7800	5300	100
	ø25	36,5	140,5	104,5	38	11	15	15	71	71	14,3	M10	0,34	+	243 PPL 205	0,15	-	244 PPL 205	8600	6250	100
	ø30	41	163	119	46	14	17,5	17,5	82,5	84	15,9	M12	0,54	+	243 PPL 206	0,24	-	244 PPL 206	12000	9000	100
	ø35	48	168,5	127	48	14	17,5	19	94,5	94,5	17,5	M12	0,78	+	243 PPL 207	0,30	-	244 PPL 207	15700	12000	50
	ø40	49,2	184	136,5	54	14	18	19,5	99	99	19	M12	0,97	+	243 PPL 208	0,35	-	244 PPL 208	17900	14300	50

FPL RULMAN YATAKLARI/BEARING INSERT

M PA PP

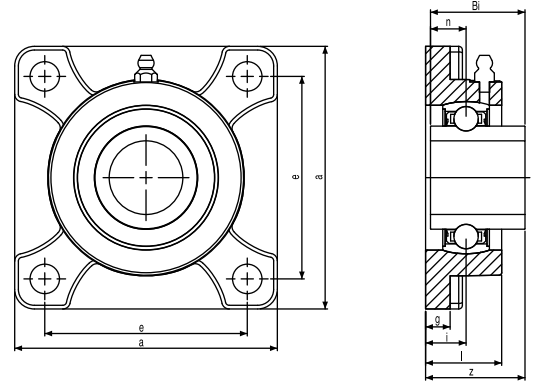
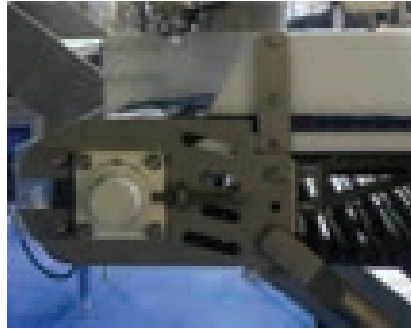

M	Ölçüler/Dimension (mm)										Metrik Bolt D. (mm)	Kg	+	Stok Kod Stock Code	Kg	-	Stok Kod Stock Code	Yük Kapasitesi Bearing Load Ratings		50
	øEJE	a	e	g	l	s	z	i	Bi	n								dyn (N)	st (N)	
PA	ø20	87	63,5	13,4	27	11	36,3	18	31	12,7	M10	0,29	+	245 FPL 204	0,13	-	246 FPL 204	7800	5300	50
	ø25	95	69	14,5	27	11	36,7	17	34	14,3	M10	0,36	+	245 FPL 205	0,17	-	246 FPL 205	8600	6250	40
	ø30	107	82,5	15	31	11	41,4	19,2	38,1	15,9	M10	0,50	+	245 FPL 206	0,20	-	246 FPL 206	12000	9000	30
	ø35	118	92	19	34	11	46,9	21,5	42,9	17,5	M12	0,74	+	245 FPL 207	0,26	-	246 FPL 207	15700	12000	20
	ø40	130	102	19	36	13	53,2	23	49,2	19	M12	0,97	+	245 FPL 208	0,35	-	246 FPL 208	17900	14300	15
PP	ø20	87	63,5	13,4	27	11	36,3	18	31	12,7	M10	0,29	+	243 FPL 204	0,13	-	244 FPL 204	7800	5300	100
	ø25	95	69	14,5	27	11	36,7	17	34	14,3	M10	0,36	+	243 FPL 205	0,17	-	244 FPL 205	8600	6250	100
	ø30	107	82,5	15	31	11	41,4	19,2	38,1	15,9	M10	0,50	+	243 FPL 206	0,20	-	244 FPL 206	12000	9000	100
	ø35	118	92	19	34	11	46,9	21,5	42,9	17,5	M12	0,74	+	243 FPL 207	0,26	-	244 FPL 207	15700	12000	50
	ø40	130	102	19	36	13	53,2	23	49,2	19	M12	0,97	+	243 FPL 208	0,35	-	244 FPL 208	17900	14300	50

*Özel üretim yapılır./On request special production is available.

NFL RULMAN YATAKLARI/BEARING INSERT

M PA PP



M	øEJE	Ölçüler/Dimension (mm)										Metrik Bolt D. (mm)	Kg	+	Stok Kod Stock Code	Kg	-	Stok Kod Stock Code	Yük Kapasitesi Bearing Load Ratings		50
		a	e	b	g	l	s	z	i	Bi	n								dyn (N)	st (N)	
PA	ø20	116	89,5	65	11,4	26,5	11	33,7	15,4	31	12,7	M10	0,24	+	245 NFL 204	0,08	-	246 NFL 204	7800	5300	50
	ø25	130	98	69	13,5	29,1	11	36,7	17	34	14,3	M10	0,30	+	245 NFL 205	0,11	-	246 NFL 205	8600	6250	40
	ø30	147	115,5	79	13,3	30,5	11	41,2	19	38,1	15,9	M10	0,45	+	245 NFL 206	0,15	-	246 NFL 206	12000	9000	30
	ø35	163	129	89	16,1	32,8	13	43,4	18	42,9	17,5	M12	0,66	+	245 NFL 207	0,18	-	246 NFL 207	15700	12000	20
	ø40	175,5	143	98	20	37,5	14	51,7	21,5	49,2	19	M12	0,87	+	245 NFL 208	0,25	-	246 NFL 208	17900	14300	15
PP	ø20	116	89,5	65	11,4	26,5	11	33,7	15,4	31	12,7	M10	0,24	+	243 NFL 204	0,08	-	244 NFL 204	7800	5300	100
	ø25	130	98	69	13,5	29,1	11	36,7	17	34	14,3	M10	0,30	+	243 NFL 205	0,11	-	244 NFL 205	8600	6250	100
	ø30	147	115,5	79	13,3	30,5	11	41,2	19	38,1	15,9	M10	0,45	+	243 NFL 206	0,15	-	244 NFL 206	12000	9000	100
	ø35	163	129	89	16,1	32,8	13	43,4	18	42,9	17,5	M12	0,66	+	243 NFL 207	0,18	-	244 NFL 207	15700	12000	50
	ø40	175,5	143	98	20	37,5	14	51,7	21,5	49,2	19	M12	0,87	+	243 NFL 208	0,25	-	244 NFL 208	17900	14300	50

TBL RULMAN YATAKLARI/BEARING INSERT

M PA PP

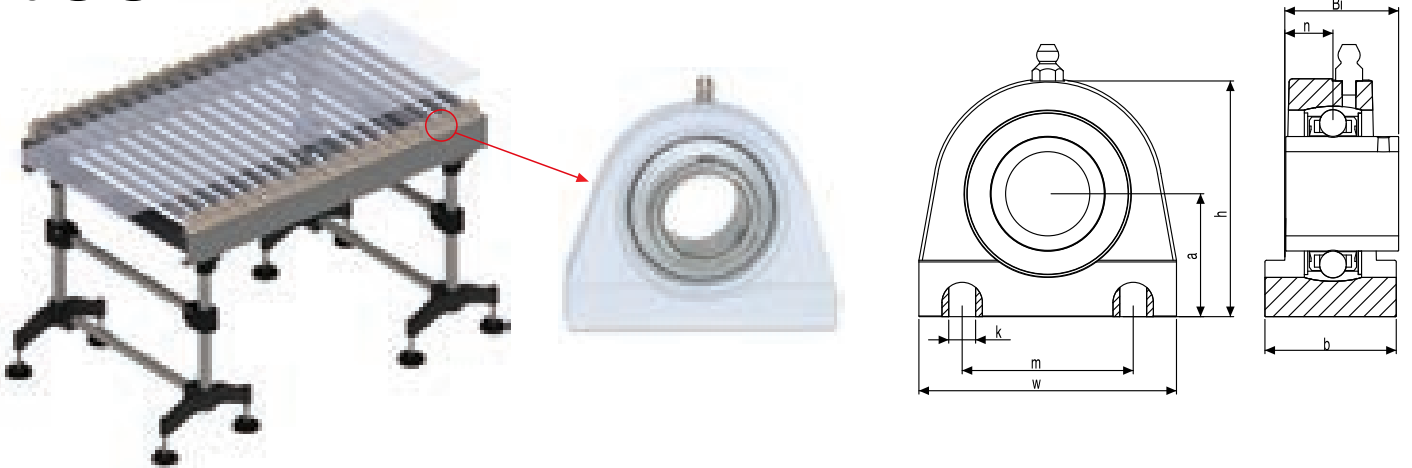

M	øEJE	Ölçüler/Dimension (mm)								Metrik Bolt D. (mm)	Kg	+	Stok Kod Stock Code	Kg	-	Stok Kod Stock Code	Yük Kapasitesi Bearing Load Ratings		50
		a	b	h	m	w	k	Bi	n								dyn (N)	st (N)	
PA	ø20	33,3	34,5	65	50,8	72	M8	31	12,7	M10	0,35	+	245 TBL 204	0,19	-	246 TBL 204	7800	5300	50
	ø25	36,5	39,5	73,5	50,8	76,5	M10	34	14,3	M10	0,40	+	245 TBL 205	0,21	-	246 TBL 205	8600	6250	40
	ø30	42,9	42,5	84	76,2	11	M10	38,1	15,9	M10	0,55	+	245 TBL 206	0,25	-	246 TBL 206	12000	9000	30
	ø35	47,6	47,5	95	82,6	13	M10	42,9	17,5	M12	0,80	+	245 TBL 207	0,32	-	246 TBL 207	15700	12000	20
	ø40	49,2	48	100,5	88,9	14	M12	49,2	19	M12	0,95	+	245 TBL 208	0,33	-	246 TBL 208	17900	14300	15
PP	ø20	33,3	34,5	65	50,8	72	M8	31	12,7	M10	0,35	+	243 TBL 204	0,19	-	244 TBL 204	7800	5300	100
	ø25	36,5	39,5	73,5	50,8	76,5	M10	34	14,3	M10	0,40	+	243 TBL 205	0,21	-	244 TBL 205	8600	6250	100
	ø30	42,9	42,5	84	76,2	11	M10	38,1	15,9	M10	0,55	+	243 TBL 206	0,25	-	244 TBL 206	12000	9000	100
	ø35	47,6	47,5	95	82,6	13	M10	42,9	17,5	M12	0,80	+	243 TBL 207	0,32	-	244 TBL 207	15700	12000	50
	ø40	49,2	48	100,5	88,9	14	M12	49,2	19	M12	0,95	+	243 TBL 208	0,33	-	244 TBL 208	17900	14300	50

*Özel üretim yapılır./On request special production is available.

RULMAN YATAKLARI / BEARING INSERT

247 Paslanmaz Rulmanlı Polyamid Yataklı

248 Paslanmaz Rulmanlı Polipropilen Yataklı



Stok Kod Stock Code	
247	
248	

247	HPL	204
247	HPL	204
248	FBL	205
	TPL	206
	LFL	207
	PPL	208
	FPL	
	NFL	
	TBL	

UC RULMAN/STEEL BEARING INSERT

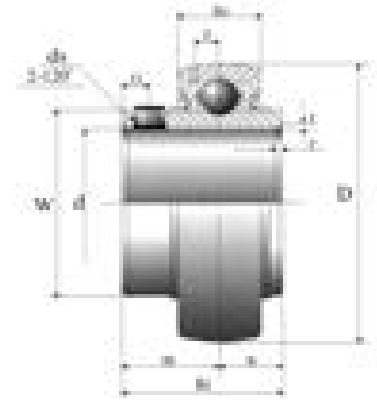

Ölçüler/Dimension (mm)											Kg	Stok Kod Stock Code	Stok Kod Stock Code	Yük Kapasitesi Bearing Load Ratings		
øEJE	D	Bi	Be	r	n	m	G	ds	T	W				dyn (N)	st (N)	
ø20	47	31	17	1,5	12,7	18,3	4,5	M6X0,75	4,5	29	0,16	245 UCZ 204	245 UCS 204	7800	5300	50
ø25	52	34	17	1,5	14,3	19,8	5	M6X0,75	4,5	34	0,19	245 UCZ 205	245 UCS 205	8600	6250	40
ø30	62	38,1	19	1,5	15,9	22,2	5	M6X0,75	4,5	40,5	0,30	245 UCZ 206	245 UCS 206	12000	9000	30
ø35	72	42,9	20	2	17,5	25,4	6	M8X1	5,1	48	0,48	245 UCZ 207	245 UCS 207	15700	12000	20
ø40	80	49,2	21	2	19	30,2	8	M8X1	5,8	53	0,62	245 UCZ 208	245 UCS 208	17900	14300	15

UCF KAPAKLI KARE RULMAN YATAĞI/SQUARE BEARINGS UNITS WITH CLOSED COVER

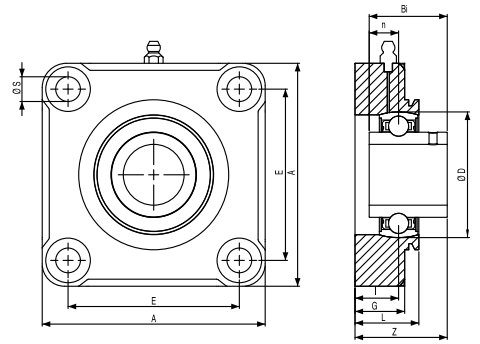

øEJE	øD	A	E	G	L	øS	Z	I	Bi	n	Kg		Stok Kod Stock Code	Kg		Stok Kod Stock Code	Yük Kapasitesi Bearing Load Ratings		
dyn (N)	st (N)																		
ø20	45	87	63,5	19,5	23,5	12	36,3	17	24,7	7	0,270	+	245 UCF 204	0,115	-	246 OOF 204	7800	5300	50
ø25	50	98	70	21,5	27	12	36,7	18	27	7,5	0,365	+	245 UCF 205	0,165	-	246 OOF 205	8600	6250	40
ø30	60	110	84,5	21,5	31,5	12	41,4	19,2	30,3	8	0,545	+	245 UCF 206	0,230	-	246 OOF 206	12000	9000	30

*Özel üretim yapılır./On request special production is available.

Rulman Modeli/Category No.:

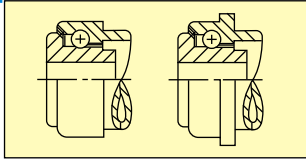

- 00** Plastik rulman (plastik tutuculu yada tutucusuz) tek sıra
Plastic bearing with or without plastic retainer, one row of balls
- 01** Plastik rulman (plastik tutuculu yada tutucusuz) Tek sıra paslanmaz
Plastic bearing with or without plastic retainer, one row of balls, stainless

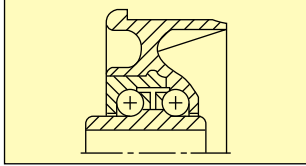

- 02** Plastik rulman plastik tutucu ile iki sıra
Plastic bearing with plastic retainer, two row of balls
- 03** Plastik rulman plastik tutucu ile iki sıra paslanmaz
Plastic bearing with plastic retainer, two row of balls, stainless balls

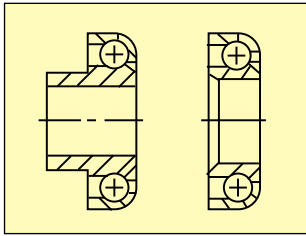

- 16** Metal rulman sıkıştırılmış sertleştirilmiş plastik tutucu ile rulman yatağı
Metal bearing, pressed, hardened, with plastic retainer, bearing bush
- 20** Metal rulman sıkıştırılmış sertleştirilmiş plastik veya metal tutucu ile rulman yatağı
Metal bearing, pressed, hardened, with plastic or metal retainer, bearing bush
- 25** Metal rulman sıkıştırılmış sertleştirilmiş plastik tutucu ile rulman yatağı
Metal bearing, pressed, hardened, with plastic retainer, bearing bush
- 30** Metal rulman sıkıştırılmış sertleştirilmiş (tutuculu yada tutucusuz) rulman yatağı
Metal bearing, pressed, hardened, with or without retainer, bearing bush
- 30-2** Metal rulman sıkıştırılmış sertleştirilmiş tutucusuz yağlanmış rulman yatağı
Metal bearing, pressed, hardened, without retainer, greased, bearing bush
- 31** Metal rulman sıkıştırılmış sertleştirilmiş tutuculu yağlanmış rulman yatağı paslanmaz
Metal bearing, pressed, hardened, with retainer, greased, bearing bush, stainless

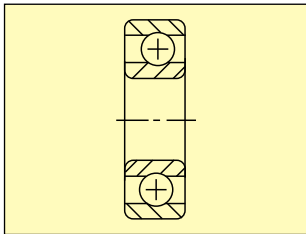

- 40** Standart makara rulman DIN 625, Tip 6202
Standard ball bearing, DIN 625, Typ 6202
- 41** Standart makara rulman DIN 625, Tip 6201
Standard ball bearing, DIN 625, Typ 6201
- 42** Standart makara rulman DIN 625, Tip 6002
Standard ball bearing, DIN 625, Typ 6002
- 43** Standart makara rulman DIN 625, Tip 6303
Standard ball bearing, DIN 625, Typ 6303
- 44** Standart makara rulman DIN 625, Tip 6204
Standard ball bearing, DIN 625, Typ 6204
- 45** Standart makara rulman DIN 625, Tip 6003
Standard ball bearing, DIN 625, Typ 6003
- 46** Standart makara rulman DIN 625, Tip 6004
Standard ball bearing, DIN 625, Typ 6004
- 47** Standart makara rulman DIN 625, Tip 6205
Standard ball bearing, DIN 625, Typ 6205



Modeli	Rulo Capı	Et Kalınlığı	Rulman Modeli	Delik Capı
KTR	16	1,0	00	6

KTR 16x1,0.00.6
Kod Oluşturma

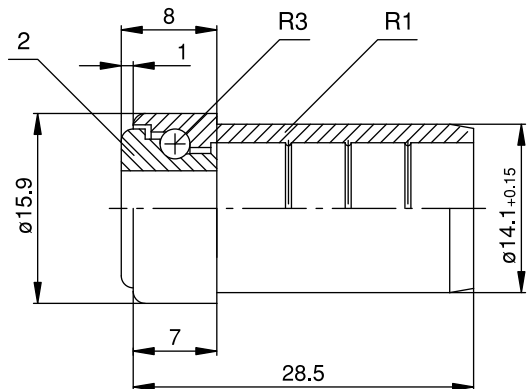

*Özel üretim yapılır./On request special production is available.

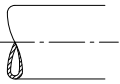
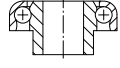
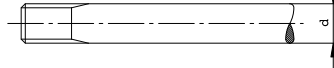
Tip Type													KTR	Yükleme Oranı Load Rating C in daN		
16x1,0	.00		5	6												3
	.01	X	5	6												3
20x1,0	.00			6	8											5
	.01	X		6	8											5
20x1,5	.00			6	8											5
	.01	X		6	8											5
30x1,0 30x1,5 30x1,8 30x2,0	.00		5	6	8	10	10,8									7
	.01	X	5	6	8	10	10,8									7
40x1,5	.00		5	6	8	10										7
	.01	X	5	6	8	10										7
10,2,3	.00		5	6	8	10										7
	.01	X	5	6	8	10										7
40x3,0	.25				8	10	∅11	12								50
50x1,5	.02			6	8	10	∅11	12								10
	.03	X		6	8	10	∅11	12								10
	.25				8	10	∅11	12								50
	.30				8	10	∅11	12	14	15						80
	.31	X			8	10	∅11	12	14	15						25
50x2,0	.40			8/M8	10	∅11	12	14	15							80
	.02			6	8	10										10
	.03	X		6	8	10										10
	.25				8	10	∅11	12	14	15						80
	.30	X			8	10	∅11	12	14	15						25
50x2,8	.31			8/M8	10	∅11	12	14	15							80
	.40			6	8	10	∅11	12								10
	.03	X		6	8	10	∅11	12								10
	.25				8	10	∅11	12								50
	.30				8	10	∅11	12	14	15						80
60x1,5	.31	X			8	10	∅11	12	14	15						25
	.40			8/M8	10	∅11	12	14	15							80
	.30				8	10	∅11	12	14	15						80
	.31	X			8	10	∅11	12	14	15						25
	.40			8/M8	10	∅11	12	14	15							80
60x2,0	.30				8	10	∅11	12	14	15						80
	.31	X			8	10	∅11	12	14	15						25
	.40			8/M8	10	∅11	12	14	15							80
60x3,0	.40			8/M8	10	∅11	12	14	15						80	
63,5x2,9	.43												17			150
	.44													20		150
65x2,0	.40			8/M8	10	∅11	12	14	15							80
	.30				8	10	∅11	12	14	15						80
	.31	X			8	10	∅11	12	14	15						25
	.41							12								150
	.42				10	∅11	12	14	15							150
	.43												17			150
80x2,0	.44													20		150
	.30				10	∅11	12	14	15							80
	.31	X			10	∅11	12	14	15							25
	.41						12									150
	.42				10	∅11	12	14	15							150
	.43												17			150
80x3,0	.44														20	150
	.44												17			150
	.30				10	∅11	12	14	15							80
	.31	X			10	∅11	12	14	15							25
	.41						12									150
89x3,0	.42				10	∅11	12	14	15							150
	.43												17			150

*Özel üretim yapılır./On request special production is available.

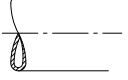
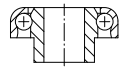
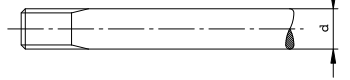
Tip Type													MTR	Yükleme Oranı Load Rating C in daN			
30x1,2	.16		8	10													30
30x1,5	.16		8	10													30
40x1,5	.20		8	10	11	12											80
40x2,0	.20		8	10	11	12											80
48x1,5	.20		8	10	11	12											80
48x2,0	.20		8	10	11	12											80
	.30		8	10	11	12											120
50x1,5	.30-2		10	10	11	12	14	15									120
	.20		8	10	11	12											80
	.30		8	10	11	12											120
	.30-2		10	10	11	12	14	15									120
50x2,0	.40		10	10	11	12		15									120
	.45											17					120
	.20		8	10	11	12											80
	.30		8	10	11	12											120
	.30-2		10	10	11	12	14	15									120
50x3,0	.40		10	10	11	12		15									120
	.45											17					120
	.30		8	10	11	12											120
	.20		8	10	11	12											80
	.30		8	10	11	12											120
60x1,5	.30-2		10	10	11	12	14	15									120
	.40		10	10	11	12		15									150
	.45											17					150
	.20		8	10	11	12											80
	.30		8	10	11	12											120
60x2,0	.30-2		10	10	11	12	14	15									120
	.40		10	10	11	12		15									150
	.45											17					150
	.30		8	10	11	12											120
	.30-2		10	10	11	12	14	15									120
60x2,5	.30		8	10	11	12											120
	.30-2		10	10	11	12	14	15									120
60x3,0	.30		8	10	11	12											120
	.30-2		10	10	11	12	14	15									120
	.40		10	10	11	12		15									150
	.45											17					150
63,5x2,9	.46											20				200	
70x2,0	.20		8	10	11	12											80
	.40		10	10	11	12		15									150
	.45											17					150
70x3,0	.40		10	10	11	12		15									150
	.45											17					150
80x2,0	.20		8	10	11	12											80
	.30		8	10	11	12		15									120
	.30-2		10	10	11	12	14	15									120
	.40		10	10	11	12		15									150
	.44								14		16	17	20				250
	.45											17					150
	.47													25			250
80x3,0	.44								14		16	17	20				250
	.47												25				250
89x3,0	.44									14		16	17	20			250
	.47												25				250
89x3,25	.44									14		16	17	20			250
108x3,25	.44										14		16	17	20		250
	.47														25		250

MTR

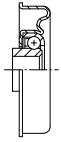

*Özel üretim yapılır./On request special production is available.

HAZIR AVARA RULOLAR/MODULAR IDLER ROLLERS

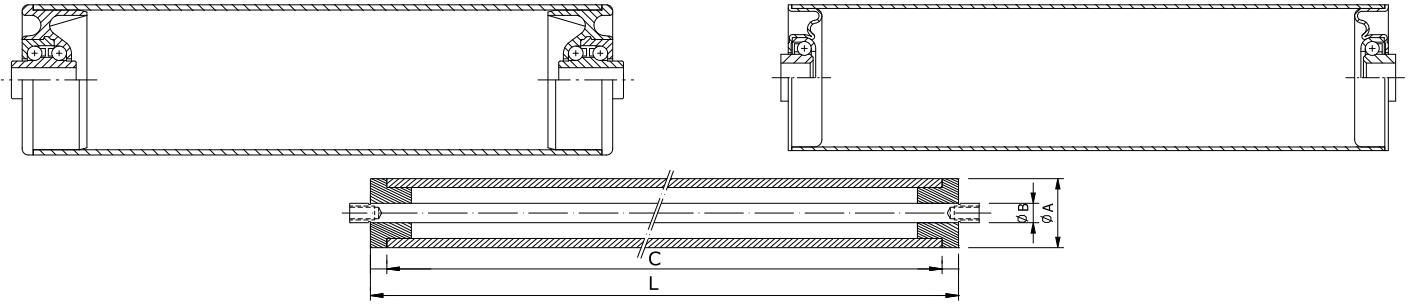

PTR

M	PE UHMW		M	C	Kg	
		32		200-250-300	30	10
		40		350-400-450	30	
		50		500-550-600	30	
		63	PE	650-700-750	30	
		75		800-850-900	30	
		90			30	

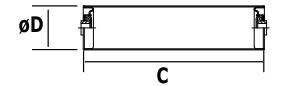

D:
C: :.....

!
FAX
+90 212 567 14 16
pazarlama@alhan-cagri.com

KTR

M	PA PP		M		Kg	
		16x1,0			3	10
		20x1,0			5	
		30x ^{1,0} _{1,8} ^{2,0} _{3,0}	PE PP PVC	200-250-300	7	
		40x ^{1,5} _{2,3} ^{3,0} _{2,9}		350-400-450	7-30	
		50x ^{1,5} _{2,0} ^{3,0} _{2,9}		500-550-600	10-25-50-80	
		60x ^{2,0} _{3,0}	ZN SS	650-700-750	25-80	
		63,5x2,9		800-850-900	150	
		65x2,0			80	
		80x3,0			25-80-150	
		89x3,0			150	



MTR

M	St37		M		Kg	
		30x ^{1,2} _{1,5}			30	10
		40x ^{1,5} _{2,0}			80	
		48x ^{1,5} _{2,0}		200-250-300	80-120	
		50x ^{1,5} _{2,0} ^{3,0} _{3,0}		350-400-450	80-120	
		60x ^{1,5} _{2,5} ^{2,0} _{3,0}	ZN SS	500-550-600	80-150	
		63,5x2,9		650-700-750	200	
		70x ^{2,0} _{3,0}		800-850-900	150	
		80x ^{2,0} _{3,0}			80-120 150-250	
		89x ^{3,0} _{3,25}			250	
		108x3,25			250	



*Özel üretim yapılır./On request special production is available.

HELOZON ve YILDIZ ÖBEĞİ/SCREW FEEDINGS COMPENENTS

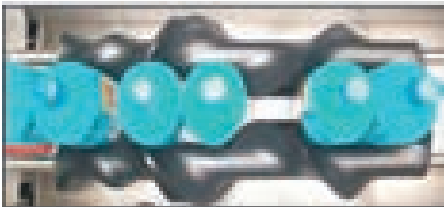
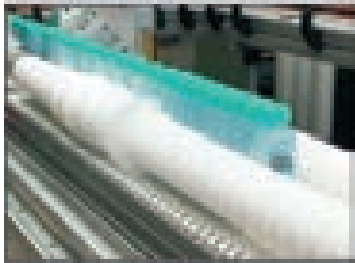
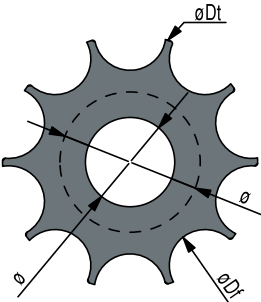
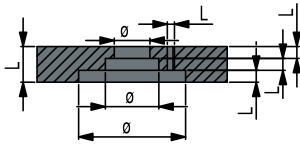
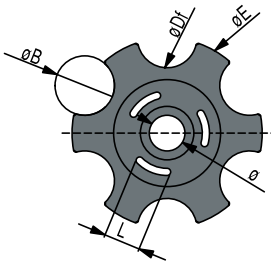
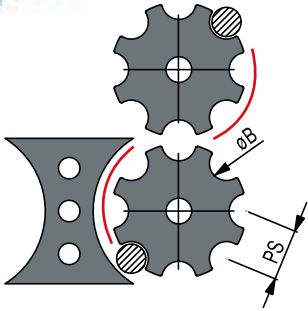

İstedığınız verileri aşağıdaki gibi belirtirseniz, ihtiyacınıza uygun olarak yıldız dişliler ve helozon üretebiliriz.

If you indicate the data we request as follow, we can manufacture the stars and screw feedings system according to your needs.

Giriş Adımı/Entry Pitch: Şişe çapı/Bottle Diameter

Çıkış Adımı/Exit Pitch: Yıldız adımı/Star Pitch

ØB: Şişe çapı+5 mm/Bottle Diameter+5 mm

E: Sonsuz kılavuz girişlerinin sayısı/Number of endless guide entries

Np: Tam dönüş geçişlerinin sayısı/Number of passes o turns

Vida Yiv Yönü/Screw thread direction (Şekilde sağ vida kullanılmıştır./Right thread in this diagram)

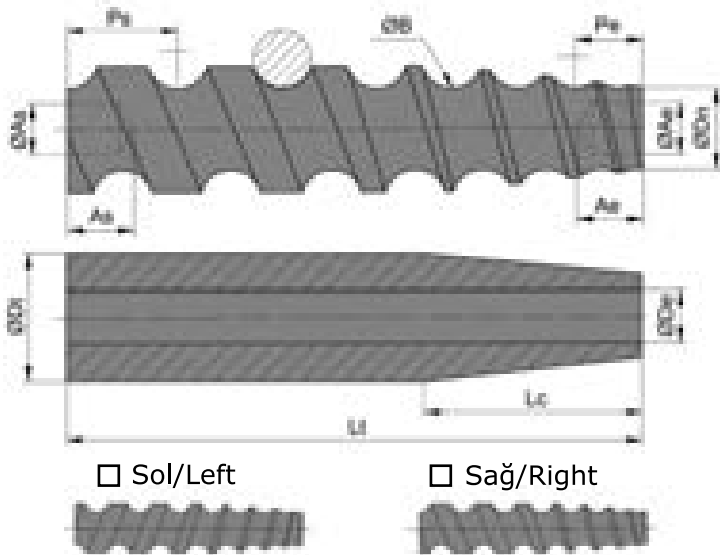

Üretimler için aşağıda detayları bulunan ölçüleri doldurunuz.

Alpolen®1000 malzeme rengi :

The following details are required for manufacture:

Alpolen®1000 material colour :

ØAe	Giriş yönündeki delik çapı/Entry side hole	
ØAs	Çıkış yönündeki delik çapı/Exit side hole	
ØB	Şişe çapı/Bottle diameter	
ØDe*	Broş çapı/Brooch diameter	
ØDt	Toplam çap/Total diameter	
ØDn	Ön göbek çapı/Front core diameter	
ØDf	Arka göbek çapı/Back core diameter	
E	Azami çap/Max diameter	
G°	Giriş koniklik açısı/Entry cone degrees	
L	Uzunluk/Length	
Lc	Giriş koniklik uzunluğu/Entry cone length	
Lt	Toplam uzunluk/Total length	
Pe	Giriş adımı/Entry pitch	
Ps	Çıkış adımı/Exit pitch	
R	Kullanılan radyüs/Radius	

Stok Kod/Stock Code

900 HIE 001

*Özel üretim yapılır./On request special production is available.

BURÇLU TAHRİK DİŞLİSİ/BUSHING GEARS

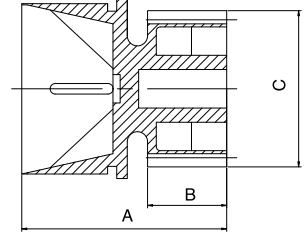
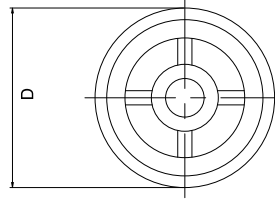
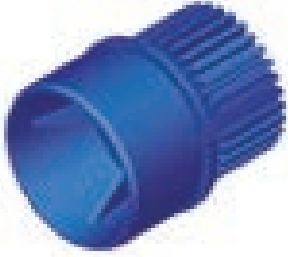

A	B	C	D	Renk/Colour	Kg	Stok Kod Stock Code	
101	39	84	88,5	Natural	0,235	261 9TD 517	10

250 RAY MAKARA/ROLLERS

M PA

Say.

C6 - D4

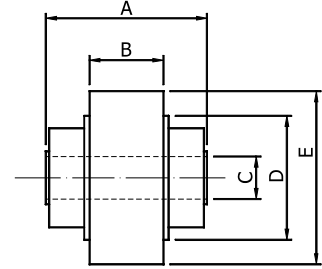

	A	B	C	D	E	Kg	Stok Kod Stock Code	
1,5"	40	20	6,5	23	36	0,025	250 036 000	100
2"	46	20	11,5	35	49	0,020	250 049 000	100

SU FİSKİYESİ/NOZZLE

M PA



Stok Kod Stock Code	
758 000 PA6	50

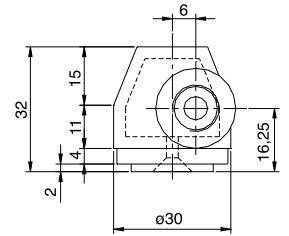
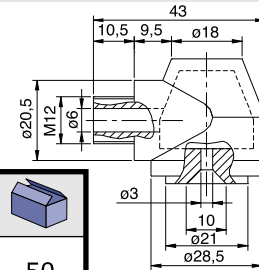

KABLO TAŞIMA BANTLARI/CABLE CHAINS

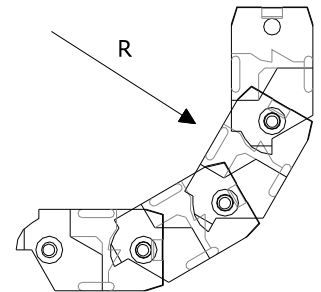
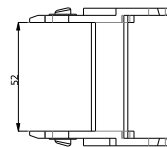
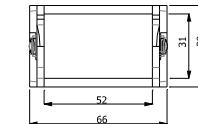
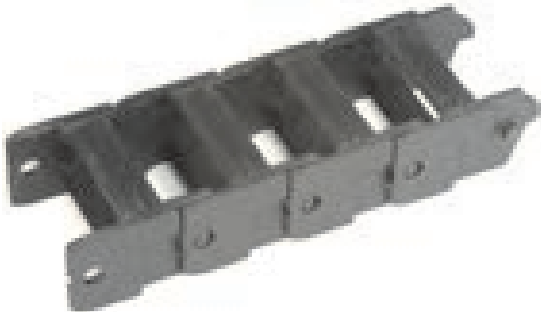

P mm.	M	R	Kg/m	Stok Kod Stock Code
52	Güçlendirilmiş Siyah Polyamid Black Reinforced Polyamide	40	0,742	753 050 030

*Özel üretim yapılır./On request special production is available.

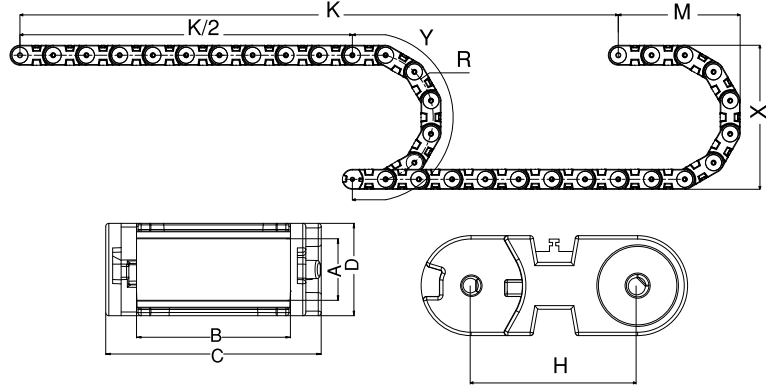
SD0 SERİSİ PLASTİK AÇIK SERİ (AÇILABİLİR BAĞLANTILI)/SD0 PLASTIC OPENING SERIES (OPENING COVER)

L: Kullanılacak Miktar/Used Length
K: Hareket Mesafesi/Movement Distance
Y: Radiüs Açılımı/Radius Distance

$$L = \frac{K}{2} + Y$$

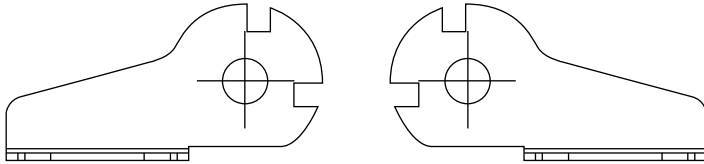

Bağlantı Ayağı
Foot of Connection

SD0
Modeli
Model

080
İç Genişlik (B)
Inner Width (B)

R170
Yarı Çap
Radius

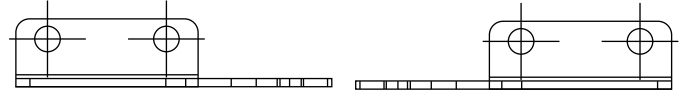

	Kanal Stok Kodu Channel Stock Code	R	A	B	C	D	Uzunluk Length mt/kg	H	X	M	Y	Ayak Bağlantı Foot Connection Stok kodu/Stock code
	SA4 015 R 40 01	40	15	15	20	23	0,224 gr	20	103	69.5	186	SA4 B01
	SBO 025 R 40 01	40	18	25	23	35	0,312 gr	30	103	81.5	186	SB0 B01
	SB1 025 R 01	40-75-100-125	20	25	27	37	0,441 gr	33	107	86.5	192	SB1 B025
	SB1 040 R 01	40-75-100-125	20	40	27	52	0,488 gr	33	177	121.5	302	SB1 B040
	SB1 050 R 01	40-75-100-125	20	50	27	62	0,653 gr	33	227	146.5	380	SB1 B050
	SB1.1 040 R01	40-75-100-125	22	40	30	56	0,700 gr	33	110	80	132	SB1.1 B040
	SB1.1 060 R01	40-75-100-125	22	60	30	76	0,800 gr	33	180	130	264	SB1.1 B060
	SB2 040 R 01	40-75-100-125	25	40	33	52	0,545 gr	40	113	95.5	204	SB2 B040
	SB1 065 R 01	40-75-100-125	25	65	33	76	0,607 gr	40	183	130.5	314	SB2 B065
	SC1K 040 R 01	75-100-150-200	30	40	40	56	0,958 gr	45	190	140.5	328	SC1 B040
	SC1K 060 R 01	75-100-150-200	30	60	40	76	1,106 gr	45	240	165.5	406	SC1 B060
	SC1K 080 R 01	75-100-150-200	30	80	40	96	1,236 gr	45	340	215.5	563	SC1 B080
	SC1 YK 040 R 01	75-100-150-200	30	40	40	56	0,955 gr	45	190	140.5	328	SC1 B040
	SD0 080 R 01	125-150-170-200-220-285-350	40	80	60	120	2,120 gr	100	310	255	592	SD0 B080
	SD0 090 R 01	125-150-170-200-220-285-350	40	90	60	130	2,160 gr	100	360	280	671	SD0 B090
	SD0 0100 R 01	125-150-170-200-220-285-350	40	100	60	140	2,200 gr	100	400	300	734	SD0 B0100
	SD0 0120 R 01	125-150-170-200-220-285-350	40	120	60	160	2,300 gr	100	460	330	828	SD0 B0120
	SD0K 080 R 01	125-150-170-200-220-285-350	40	80	60	120	2,300 gr	100	310	255	592	SD0 B080
	SD0K 090 R 01	125-150-170-200-220-285-350	40	90	60	130	2,400 gr	100	360	380	671	SD0 B090
	SD0K 0100 R 01	125-150-170-200-220-285-350	40	100	60	140	2,500 gr	100	400	300	734	SD0 B0100
	SD0K 0120 R 01	125-150-170-200-220-285-350	40	120	60	160	2,700 gr	100	460	330	828	SD0 B0120

*Özel üretim yapılır./On request special production is available.

MODEL: DSH

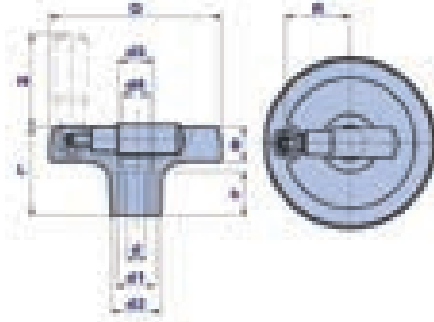

D	L	B	d2	d3	d4	d1	d	h	H	R	Gr	Stok Kod Stock Code	
80	45	21	24	14	10	16	6	22	49	28	128	32080C	10
80	45	21	24	14	10	20	8	22	49	28	138	32080D	
80	45	21	24	14	10	20	10	22	49	28	134	32080E	
100	48	22	28	18	14	20	10	22	57	37	160	32100E	
100	48	22	28	18	14	20	12	22	57	37	154	32100F	
125	65	25	36	25,5	20	28	10	32	68	47	385	32100E	

MODEL: VSI

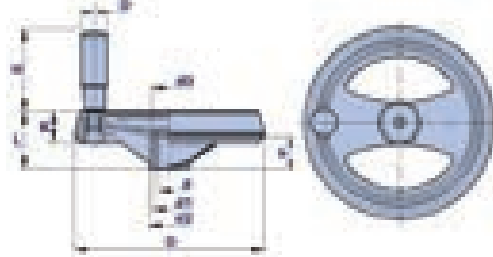

D	L	B	d2	d4	d	h	d1	H	D1	Gr	Stok Kod Stock Code	
120	40	19	25	19	10	20	20	65	22	214	01432E	10
120	40	19	25	19	12	20	20	65	22	211	01432F	
120	40	19	25	19	14	20	23	65	22	218	01432G	
120	40	19	25	19	15	20	23	65	22	205	01432H	
120	40	19	25	19	16	20	23	65	22	213	01432I	
160	47	25	34	29	10	26	20	65	22	348	01442E	
160	47	25	34	29	12	26	20	65	22	326	01442F*	
160	47	25	34	29	14	26	25	65	22	348	01442G	
160	47	25	34	29	15	26	25	65	22	342	01442H	
160	47	25	34	29	16	26	25	65	22	344	01442I	
160	47	25	34	29	17	26	28	65	22	336	01442L	
160	47	25	34	29	18	26	28	65	22	348	01442M*	
160	47	25	34	29	20	26	28	65	22	336	01442N	
160	47	25	34	29	19	26	28	65	22	340	01442O*	
160	47	25	34	29	25	26	30	65	22	320	01442S*	
200	56	29	40	29	10	26	20	70	26	506	01452E	
200	56	29	40	29	12	26	20	70	26	498	01452F*	
200	56	29	40	29	14	26	25	70	26	494	01452G	
200	56	29	40	29	15	26	25	70	26	524	01452H*	
200	56	29	40	29	16	26	25	70	26	530	01452I	
200	56	29	40	29	17	26	28	70	26	506	01452L*	
200	56	29	40	29	18	26	28	70	26	494	01452M*	

*Özel üretim yapılır./On request special production is available.

MODEL: DSF

M PA

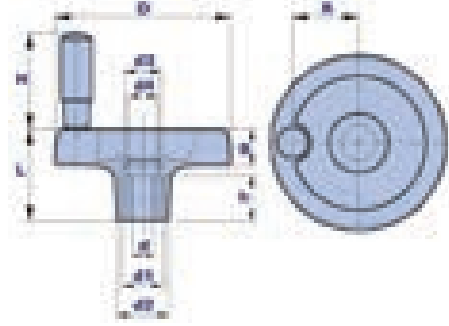

D	L	B	d2	d3	d4	d1	d	h	H	R	Gr	Stok Kod Stock Code	
80	45	21	24	14	10	16	27	22	49	28	128	31080C	10
80	45	21	24	14	10	20	27	22	49	28	138	31080D	
80	45	21	24	14	10	20	27	22	49	28	134	31080E	
100	48	22	28	18	14	20	35	22	57	37	160	31100E	
100	48	22	28	18	14	20	35	22	57	37	154	31100F	
125	65	25	36	25,5	20	28	35	32	68	37	385	31125E	
125	65	25	36	25,5	20	28	35	32	68	47	399	31125F	
125	65	25	36	25,5	20	28	35	32	68	47	412	31125G	
125	65	25	36	25,5	20	28	35	32	68	47	412	31125L*	
125	65	25	36	25,5	20	28	47	32	68	47	412	31125N*	
160	80	27	46	40	23	28	47	32	80	60	490	31160G	
160	80	27	46	40	23	28	47	32	80	60	485	31160I	

MODEL: VM

M PA

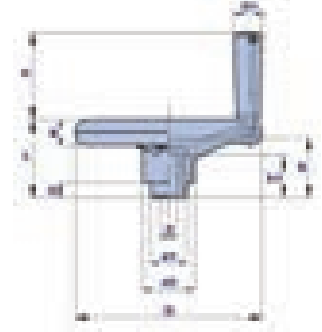

D	L	B	d2	I2	h	d	h1	d1	H	d1	Gr	Stok Kod Stock Code	
100	45	16	32	10	36	8	27	24	45	19	223	01WM10D	10
125	51	17	34	10	39	10	27	24	55	19	264	01WM12E	
125	51	17	34	10	39	16	27	24	55	19	248	01WM12M	
150	61	21	38	13	50	11	35	28	65	23	452	01WM15F	
150	61	21	38	13	50	16	35	28	65	23	452	01WM15M	
150	61	21	38	13	50	20	35	28	65	23	428	01WM15Q	
175	65	22	43	15	52	11	35	28	80	28	544	01WM17F	
175	65	22	43	15	52	16	35	28	80	28	560	01WM17M	
175	65	22	43	15	52	20	35	28	80	28	574	01WM17Q	
200	83	23	48	18	65	11	47	35	80	28	696	01WM20F	
200	83	23	48	18	65	18	47	35	80	28	674	01WM20O	
200	83	23	48	18	65	20	47	35	80	28	670	01WM20Q	

*Özel üretim yapılır./On request special production is available.

MODEL: VS

M PA



D	L	B	d2	d3	d	h	d1	Gr	Stok Kod Stock Code	
120	40	19	25	19	10	20	20	146	01402E	10
120	40	19	25	19	12	20	20	138	01402F	
120	40	19	25	19	M12	20	20	138	01402FF	
120	40	19	25	19	14	20	23	130	01402G	
120	40	19	25	19	15	20	23	124	01402H	
120	40	19	25	19	16	20	23	116	01402I	
160	47	25	34	29	10	26	20	310	01412E	
160	47	25	34	29	12	26	20	304	01412F	
160	47	25	34	29	14	26	25	290	01412G	
160	47	25	34	29	15	26	25	280	01412H	
160	47	25	34	29	16	26	25	270	01412I	
160	47	25	34	29	17	26	28	264	01412L	
160	47	25	34	29	18	26	28	272	01412M	
160	47	25	34	29	20	26	28	270	01412N	
160	47	25	34	29	19	26	28	270	01412O	
200	47	25	34	29	25	26	30	250	01412S	
200	56	29	40	29	10	26	20	428	01422E	
200	56	29	40	29	12	26	20	416	01422F	
200	56	29	40	29	14	26	25	406	01422G	
200	56	29	40	29	15	26	25	446	01422H	
200	56	29	40	29	16	26	25	450	01422I	
200	56	29	40	29	17	26	28	430	01412L	
200	56	29	40	29	18	26	28	426	01412M	

MODEL: VR

M PA

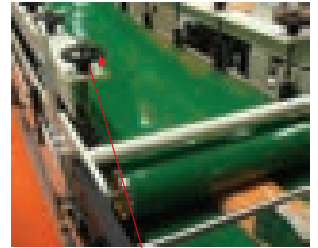
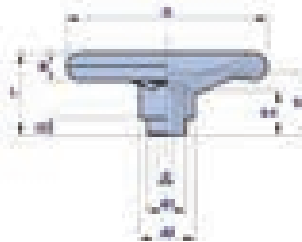

D	L	B	d2	I2	h	d	h1	d1	Gr	Stok Kod Stock Code	
100	45	16	32	10	36	8	27	24	186	01VR10D	10
125	51	17	34	10	39	10	27	24	236	01VR12E	
125	51	17	34	10	39	16	27	24	274	01VR12M	
150	61	21	38	13	50	11	35	28	390	01VR15F	
150	61	21	38	13	50	16	35	28	400	01VR15M	
150	61	21	38	13	50	20	35	28	420	01VR15Q	
175	65	22	43	15	52	11	35	28	520	01VR17F	
175	65	22	43	15	52	16	35	28	570	01VR17M	
175	65	22	43	15	52	20	35	28	572	01VR17Q	
200	83	23	48	18	65	11	47	35	816	01VR20F	
200	83	23	48	18	65	18	47	35	880	01VR20O	
200	83	23	48	18	65	20	47	35	883	01VR20Q	



*Özel üretim yapılır./On request special production is available.

MODEL: THP

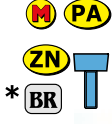

01THP

Öbek Kodu
Group Code

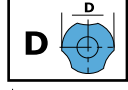

Tutgaç Çapı
Knob Diameter

D

- 20
- 25
- 30
- 40
- 50
- 60

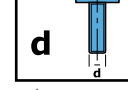

Saplama Çapı
Spindle Diameter

d

- A M4
- B M5
- C M6
- D M8
- E M10
- F M12
- G M14
- H M16



Saplama Boyu
Spindle Length

I

- 10
- 15
- 20
- 25
- 30
- 40
- 50
- 60
- 70

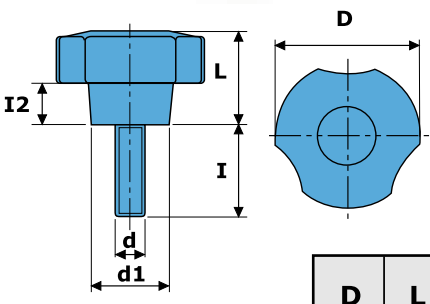

D	L	d1	I2	d	I	Gr	Stok Kod Stock Code	
20	13	13	5	M4	10	4	01THP20A10	100
-	-	-	-	-	-	-	01THP	

MODEL: MD30-AN



Renk/Color	Stok Kod/Stock Code
	01MD305282
	01MD305055
	01MD305284

MODEL: PF

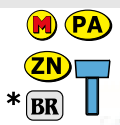

01PF

Öbek Kodu
Group Code

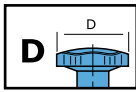

Tutgaç Çapı
Knob Diameter

D

- 2 → 20
- 3 → 30
- 4 → 40
- 5 → 50
- 6 → 60

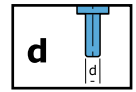

Saplama Çapı
Spindle Diameter

d

- B → M5
- C → M6
- D → M8
- E → M10
- F → M12

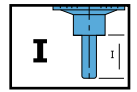

Saplama Boyu
Spindle Length

I

- 10
- 15
- 20
- 25
- 30
- 35
- 40
- 45
- 50
- 60
- 65
- 70

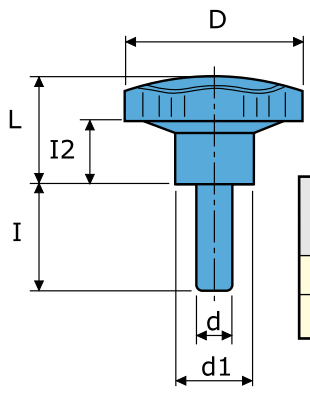

D	L	d1	I2	d	I	Gr	Stok Kod Stock Code	
20	17	13	10	M5	10	9	01PF2B10	100
-	-	-	-	-	-	-	01PF	

*Özel üretim yapılır./On request special production is available.

MODEL: THB

M PA

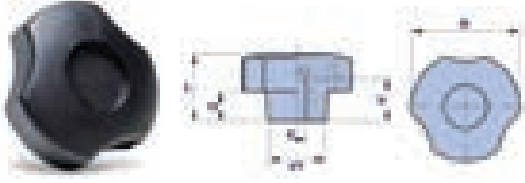

D	L	d1	I2	d	h	Gr	Stok Kod Stock Code	
20	13	13	5	M4	9	5	01THB20A	100
20	13	13	5	M5	9	6	01THB20B	
20	13	13	5	M6	9	5	01THB20C	
25	16	14	6	M4	9	8	01THB25A	
25	16	14	6	M5	9	8	01THB25B	
25	16	14	6	M6	9	8	01THB25C	
25	16	14	6	M8	9	10	01THB25D	
30	19	17	7	M5	11	12	01THB30B	
30	19	17	7	M6	11	12	01THB30C	
30	19	17	7	M8	11	13	01THB30D	
30	19	17	7	M10	11	13	01THB30E	
40	25	21	11	M6	16	22	01THB40C	
40	25	21	11	M8	16	24	01THB40D	
40	25	21	11	M10	16	26	01THB40E	
50	30	24	13	M6	16	38	01THB50C	
50	30	24	13	M8	16	35	01THB50D	
50	30	24	13	M10	16	32	01THB50E	
50	30	24	13	M12	16	29	01THB50F	
60	38	28	17	M8	22	68	01THB60D	
60	38	28	17	M10	22	71	01THB60E	
60	38	28	17	M12	22	75	01THB60F	
60	38	28	17	M14	22	72	01THB60N	
60	38	30	17	M16	22	70	01THB60P	
80	39	30	17	M10	22	95	01THB80E	
80	39	30	17	M12	22	92	01THB80F	
80	39	30	17	M14	22	90	01THB80N	
80	39	30	17	M16	22	86	01THB80P	
80	39	30	17	M20	22	84	01THB80Q	

MODEL: THPB

M PA

***ZN**
BR

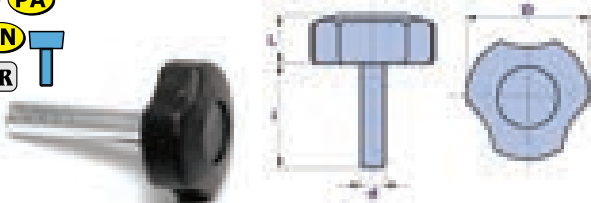

D	L	I	d	Gr	Stok Kod Stock Code	
30	12	10	M6	12	01THPB30C10	100
30	12	16	M6	15	01THPB30C16	
30	12	20	M6	18	01THPB30C20	
30	12	10	M8	17	01THPB30D10	
30	12	16	M8	19	01THPB30D16	
30	12	20	M8	20	01THPB30D20	
30	12	38	M8	25	01THPB30D38	

MODEL: PB

M PA

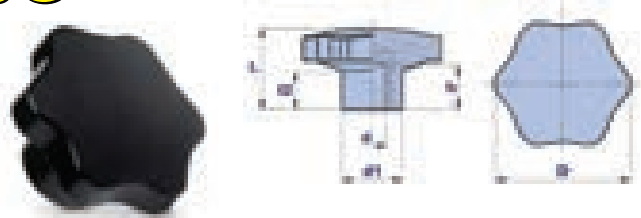

D	L	d1	I2	d	h	Gr	Stok Kod Stock Code	
20	17	13	10	M4	10	5	01PB2A	30
20	17	13	10	M5	10	7	01PB2B	
20	17	13	10	M6	10	7	01PB2C	
30	21	16	12	M5	12	12	01PB3B	
30	21	16	12	M6	12	19	01PB3BC	
30	21	16	12	M8	12	23	01PB3BD	
35	27	18	13	M6	12	11	01PB3C	
35	27	18	13	M8	12	13	01PB3D	
40	27	20	14	M6	14	24	01PB4C	
40	27	20	14	M8	14	26	01PB4D	
40	27	20	14	M10	14	56	01PB4E	
40	27	20	14	M12	14	30	01PB4F	
50	30	22	16	M6	16	40	01PB5C	
50	30	22	16	M8	16	43	01PB5D	
50	30	22	16	M10	16	40	01PB5E	
50	30	22	16	M12	16	37	01PB5F	
60	33	25	15	M8	16	62	01PB6D	
60	33	25	15	M10	16	60	01PB6E	
60	33	25	15	M12	16	57	01PB6F	
70	41	30	19	M8	16	96	01PB7D	
70	41	30	19	M10	16	95	01PB7E	
70	41	30	19	M12	16	95	01PB7F	
70	41	30	19	M14	16	93	01PB7N	
80	44	32	22	M10	20	125	01PB8E	
80	44	32	22	M12	20	125	01PB8F	
80	44	32	22	M14	20	125	01PB8N	
80	44	32	22	M16	20	127	01PB8P	
90	50	35	24	M10	20	185	01PB9E	
90	50	35	24	M12	20	170	01PB9F	
90	50	35	24	M14	20	176	01PB9N	
90	50	35	24	M16	20	190	01PB9P	

MODEL: 200F

M PA

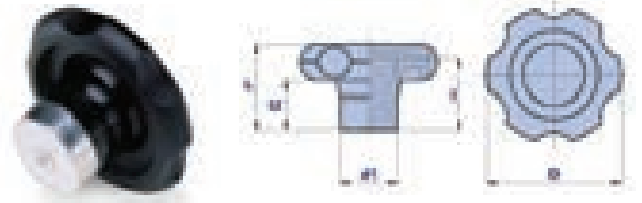

D	L	I2	d1	I	Gr	Stok Kod Stock Code	
52	33	20	22	27	68	01200F1	100
70	42	22	28	35	160	01200F2	
90	50	24	35	40	331	01200F3	

*Özel üretim yapılır./On request special production is available.



ÇAĞRI[®]
ENDÜSTRİ A.Ş.

ALHAN[®]





ÇAĞRI[®]
ENDÜSTRİ A.Ş.

ALHAN[®]

**ALÜMİNYUM PROFİL VE ELEMANLARI
ALUMINIUM PROFILES & COMPONENTS**





ÇAĞRI[®]
ENDÜSTRİ A.Ş.

ALHAN[®]

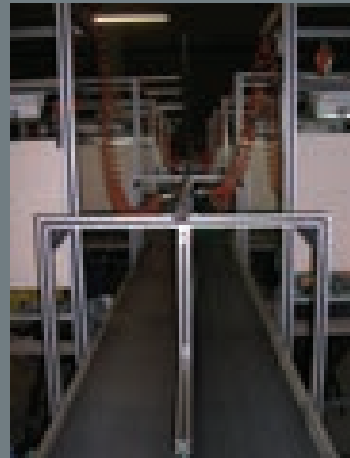
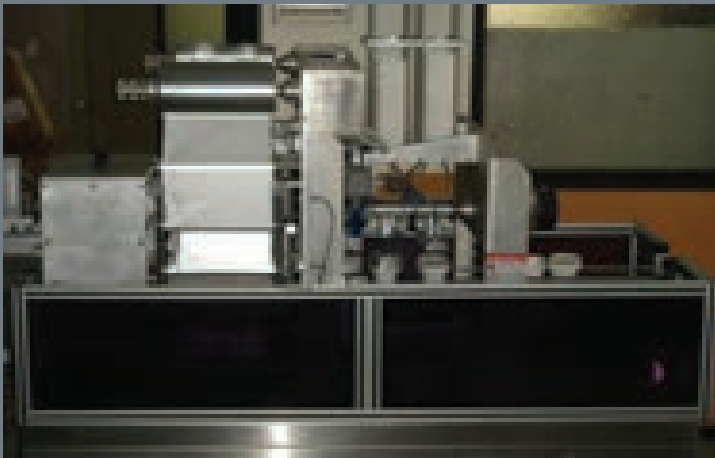
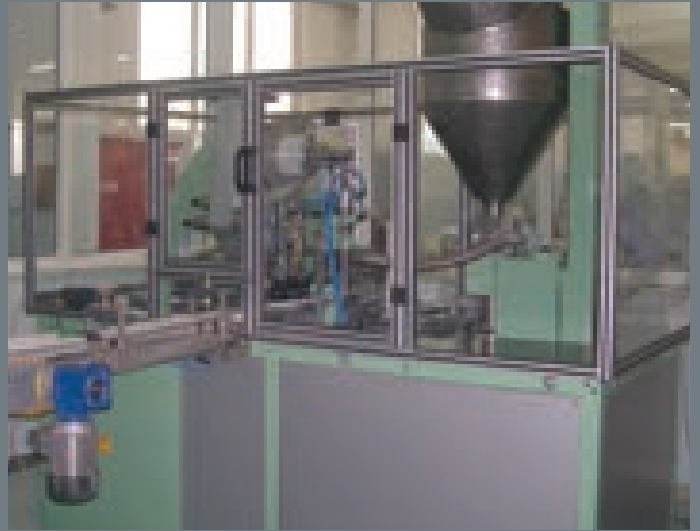
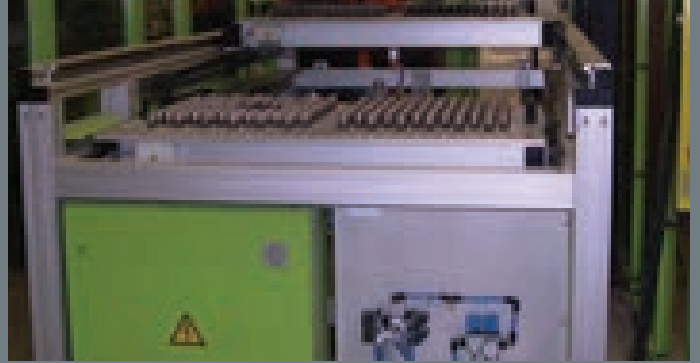
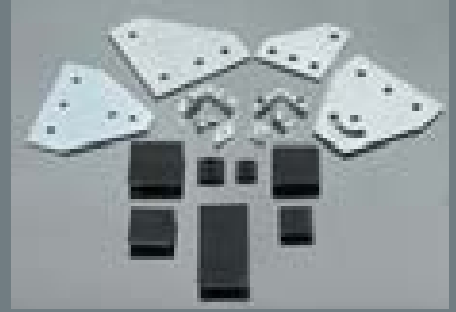
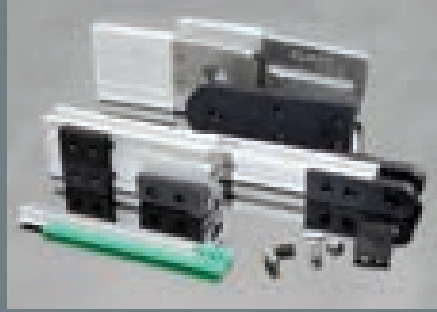
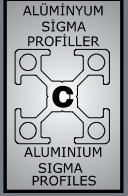



20 x 20 ELOKSALLI SİGMA ALÜMİNYUM PROFİL/20 X 20 SILVER ANODIZED ALUMINIUM PROFILE

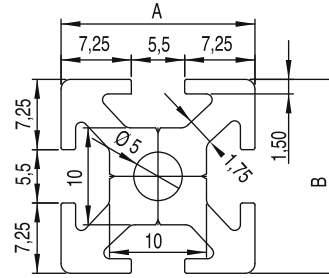
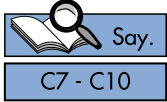

A	B	Kesit Çevresi Section Surroundings (mm)	I	W	Alan/Area (mm ²)	Kg/m	Stok Kod Stock Code	L (m)
20	20	160,5	$I_x=0,63 \text{ cm}^4$ $I_y=0,63 \text{ cm}^4$	$W_x=0,63 \text{ cm}^3$ $W_y=0,63 \text{ cm}^3$	194,98	0,554	765 020 020 765 020 021	3 6

25 x 25 ELOKSALLI SİGMA ALÜMİNYUM PROFİL/25 X 25 SILVER ANODIZED ALUMINIUM PROFILE

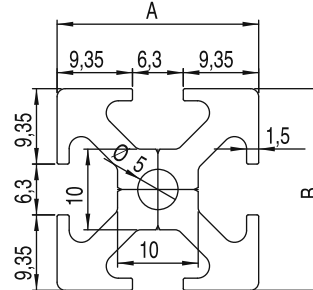
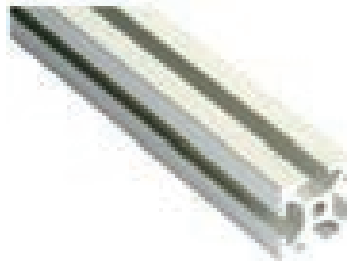

A	B	Kesit Çevresi Section Surroundings (mm)	I	W	Alan/Area (mm ²)	Kg/m	Stok Kod Stock Code	L (m)
25	25	204	$I_x=0,68 \text{ cm}^4$ $I_y=0,68 \text{ cm}^4$	$W_x=1,344 \text{ cm}^3$ $W_y=1,344 \text{ cm}^3$	263,99	0,751	765 025 025 765 025 026	3 6

30 x 30 ELOKSALLI SİGMA ALÜMİNYUM PROFİL/30 X 30 SILVER ANODIZED ALUMINIUM PROFILE

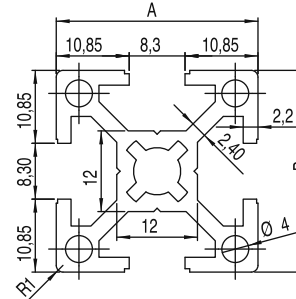
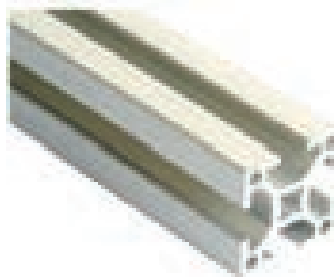

A	B	Kesit Çevresi Section Surroundings (mm)	I	W	Alan/Area (mm ²)	Kg/m	Stok Kod Stock Code	L (m)
30	30	239	$I_x=2,963 \text{ cm}^4$ $I_y=2,963 \text{ cm}^4$	$W_x=1,975 \text{ cm}^3$ $W_y=1,975 \text{ cm}^3$	329,15	0,937	765 030 030 765 030 031	3 6

*Özel üretim yapılır./On request special production is available.

50x50 ELOKSALLI SİGMA ALÜMİNYUM PROFİL/50x50 SILVER ANODIZED ALUMINIUM PROFILE

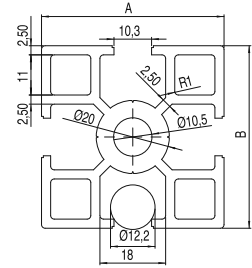
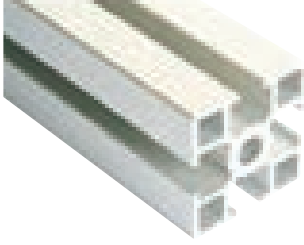

A	B	Kesit Çevresi Section Surroundings(mm)	I	W	Alan/Area (mm ²)	Kg/m	Stok Kod Stock Code	L (m)
50	50	375	$I_x=20,58\text{cm}^4$ $I_y=20,58\text{cm}^4$	$W_x=8,232\text{cm}^3$ $W_y=8,232\text{cm}^3$	886,27	2,521	765 050 050 765 050 051	3 6

25x150 ELOKSALLI KONVEYÖR YAN ŞASE ALÜMİNYUM PROFİL/25x150 SILVER ANODIZED ALUMINIUM PROFILE

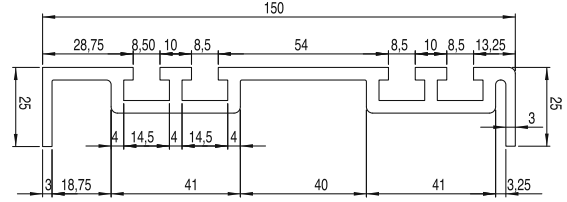

Kesit Çevresi Section Surroundings(mm)	I	W	Alan/Area (mm ²)	Kg/m	Stok Kod Stock Code	L (m)
560	$I_x=3,454\text{cm}^4$ $I_y=244,716\text{cm}^4$	$W_x=0,196\text{cm}^3$ $W_y=3,155\text{cm}^3$	1070,17	3,045	765 025 150 765 025 151	3 6

85X75 ELOKSALLI SİGMA ALÜMİNYUM PROFİL/85X75 SILVER ANODIZED ALUMINIUM PROFILE

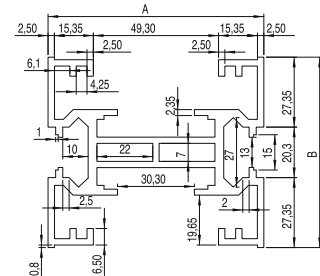

A	B	Kesit Çevresi Section Surroundings(mm)	I	W	Alan/Area (mm ²)	Kg/m	Stok Kod Stock Code	L (m)
85	75	208	$I_x=5,17\text{cm}^4$ $I_y=1,19\text{cm}^4$	$W_x=1,71\text{cm}^3$ $W_y=1,71\text{cm}^3$	1332	3,597	765 085 075 765 085 076	3 6

BAKLAVA DİLİMLİ KANAL SOMUNU/NUT FOR SIGMA PROFILE

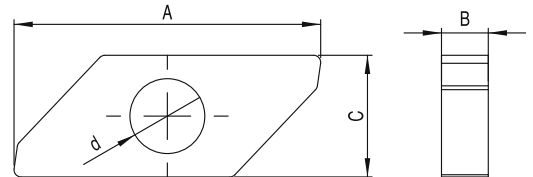

A	B	C	d		Kg	Stok Kod Stock Code	
33	5	13	M8	Çinko Kaplama Saç Zinc Plated Sheet Metal	0,008	766 011 004	250
33	4	13	M6		0,009	766 011 005	
33	4	13	M5		0,010	766 011 006	

*Özel üretim yapılır./On request special production is available.



*Özel üretim yapılır./On request special production is available.

40mm C PROFİL İÇİN ALÜMİNYUM PROFİL/SILVER ANODIZED ALUMINIUM PROFILE FOR GUIDES

M **AL** **SS**

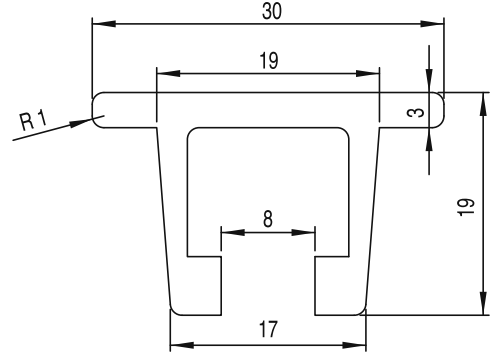

M	Kesit Çevresi Section Surroundings (mm)	Alan/Area (mm ²)	Kg/m	Stok Kod Stock Code	L (m)
Alüminyum	299	118,372	0,455	206 APC 040 AL	3
		118,372	0,455	206 APC 041 AL	6
		118,372	1.420	206 APC 042 SS	3

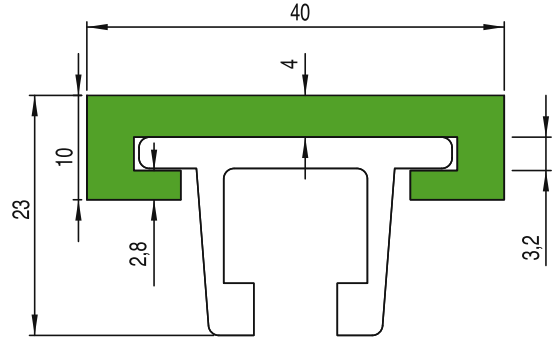

M	Kesit Çevresi Section Surroundings (mm)	Alan/Area (mm ²)	Kg/m	Stok Kod Stock Code	L (m)
ALPOLEN® 1000	239	118,372	0,213	206 AGC 040	3
				206 AGC 041	6

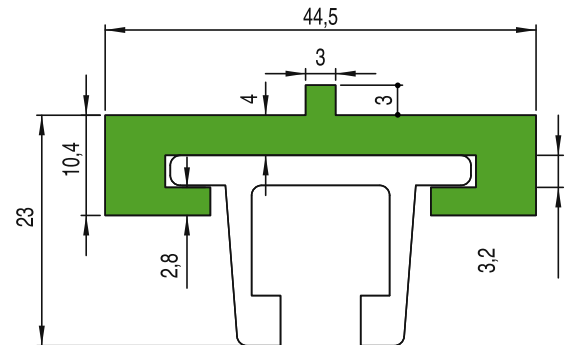
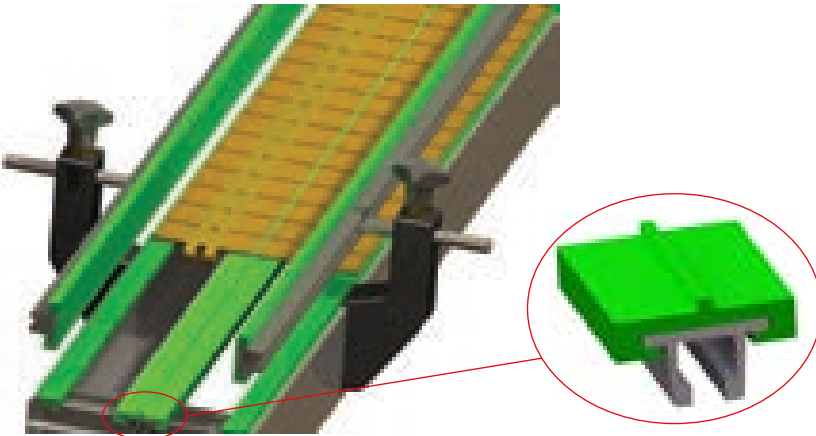

M	Kesit Çevresi Section Surroundings (mm)	Alan/Area (mm ²)	Kg/m	Stok Kod Stock Code	L (m)
ALPOLEN® 1000	239	118,372	0,224	265 BSC 040	3
				265 BSC 041	6

*Özel üretim yapılır./On request special production is available.

106 x 120 ALÜMİNYUM PROFİL MONTAJ HATTI İÇİN/106 x 120 ASSEMBLY LINE ALUMINIUM PROFILE



Say. D4



765 106 120

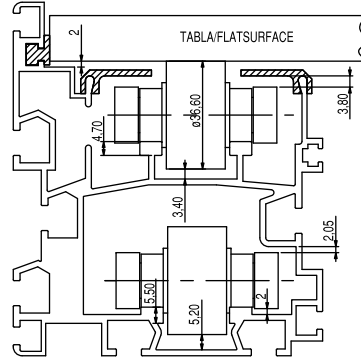

765 000 002

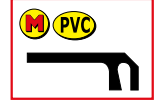

766 016 033

AL

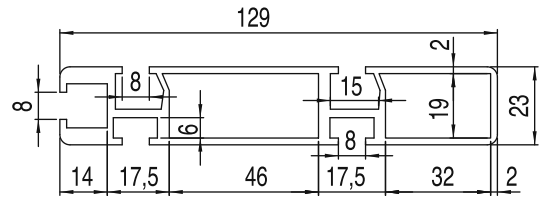

Kesit Çevresi Section Surroundings (mm)	I	W	Alan/Area (mm ²)	Kg/m	Stok Kod Stock Code	L (m)
425	$I_x=22,018 \text{ cm}^4$ $I_y=104,556 \text{ cm}^4$	$W_x=9,68 \text{ cm}^3$ $W_y=19,125 \text{ cm}^3$	1340,30	2,295	765 023 129 765 023 130	3 6

25X105 KONVEYÖR YAN ŞASE ALÜMİNYUM PROFİL ELOKSALLI/25X105 STRUCTURAL SILVER ANODIZED ALUMINIUM PROFILE

AL

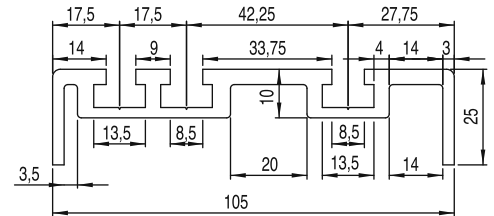
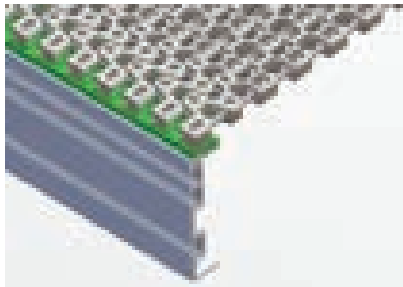

Kesit Çevresi Section Surroundings (mm)	I	W	Alan/Area (mm ²)	Kg/m	Stok Kod Stock Code	L (m)
428	$I_x=2,42 \text{ cm}^4$ $I_y=87,133 \text{ cm}^4$	$W_x=0,133 \text{ cm}^3$ $W_y=1,6 \text{ cm}^3$	750,61	2,136	765 025 105 765 025 106	3 6

25X115 KONVEYÖR YAN ŞASE ALÜMİNYUM PROFİL ELOKSALLI/25X115 STRUCTURAL SILVER ANODIZED ALUMINIUM PROFILE

AL

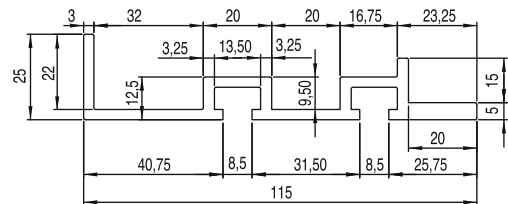
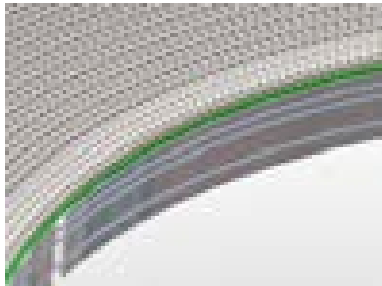

Kesit Çevresi Section Surroundings (mm)	I	W	Alan/Area (mm ²)	Kg/m	Stok Kod Stock Code	L (m)
381,28	$I_x=1,909 \text{ cm}^4$ $I_y=78,568 \text{ cm}^4$	$W_x=0,1 \text{ cm}^3$ $W_y=1,27 \text{ cm}^3$	611,5	1,785	765 025 115 765 025 116	3 6

*Özel üretim yapılır./On request special production is available.

50X88 KONVEYÖR YAN ŞASE ALÜMİNYUM PROFİL ELOKSALLI/50X88 STRUCTURAL SILVER ANODIZED ALUMINIUM PROFILE

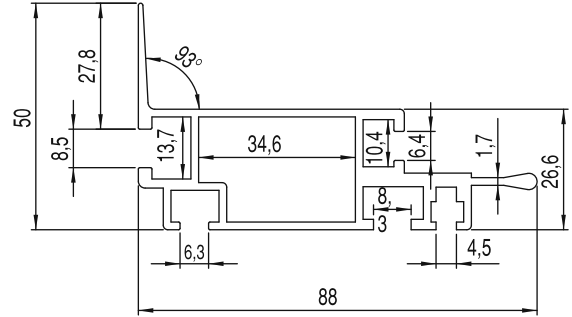
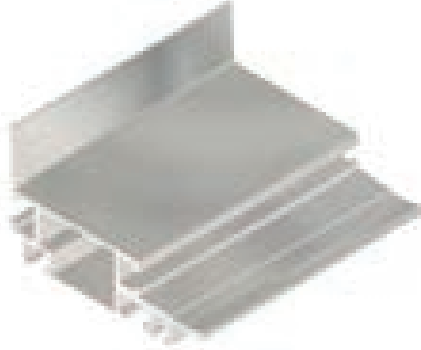

Kesit Çevresi Section Surroundings (mm)	I	W	Alan/Area (mm ²)	Kg/m	Stok Kod Stock Code	L (m)
410	$I_x=5,988 \text{ cm}^4$ $I_y=35,252 \text{ cm}^4$	$W_x=0,419 \text{ cm}^3$ $W_y=1,09 \text{ cm}^3$	532,35	1,514	765 050 088 765 050 089	3 6

50X118 KONVEYÖR YAN ŞASE ALÜMİNYUM PROFİL ELOKSALLI/50X118 STRUCTURAL SILVER ANODIZED ALUMINIUM PROFILE

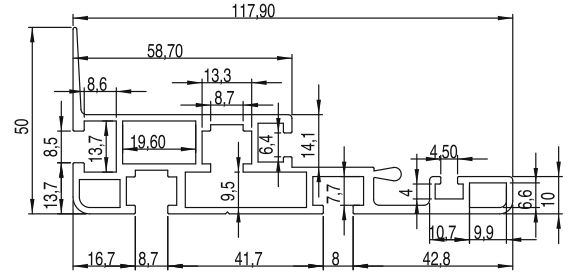
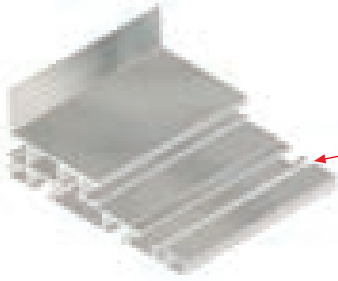

Kesit Çevresi Section Surroundings(mm)	I	W	Alan/Area (mm ²)	Kg/m	Stok Kod Stock Code	L (m)
501	$I_x=8,238 \text{ cm}^4$ $I_y=94,324 \text{ cm}^4$	$W_x=0,678 \text{ cm}^3$ $W_y=1,918 \text{ cm}^3$	784,04	2,231	765 025 117 765 025 118	3 6

45X165 AĞIR TİP ALÜMİNYUM YAN ŞASE PROFİL ELOKSALLI/45X165 STRUCTURAL SILVER ANODOZİD ALUMINIUM PROFILE

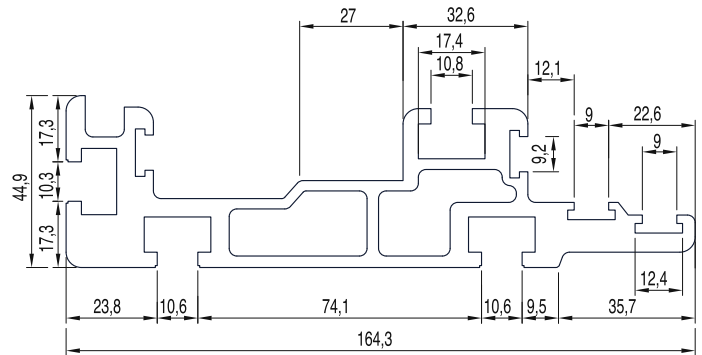
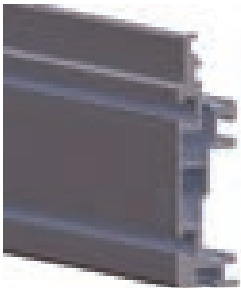

Kesit Çevresi Section Surroundings(mm)	I	W	Alan/Area (mm ²)	Kg/m	Stok Kod Stock Code	L (m)
501	$I_x=12,456 \text{ cm}^4$ $I_y=124,358 \text{ cm}^4$	$W_x=0,923 \text{ cm}^3$ $W_y=2,375 \text{ cm}^3$	1991,61	5,667	765 045 165 765 045 166	3 6

*Özel üretim yapılır./On request special production is available.

BAYRAK KÖŞE BAĞLANTI (75X75)/CORNER CONNECTION (75X75)

M ZN

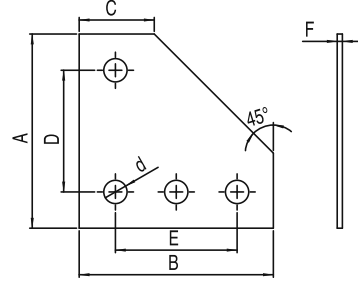
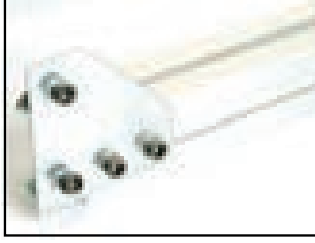

A	B	C	D	E	F	d	M	Kg	Stok Kod Stock Code	
75	75	29	47	47	2	9	Çinko Kaplama Sac Zinc Plated Sheet Metal	0,065	766 013 070	25

BAYRAK KÖŞE BAĞLANTI (110X110)/CORNER CONNECTION (110X110)

M ZN

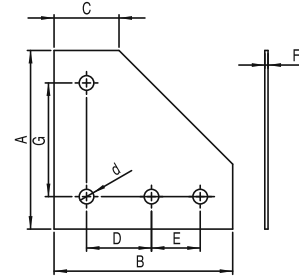

A	B	C	D	E	F	G	d	M	Kg	Stok Kod Stock Code	
110	110	40	40	30	2	70	M9	Çinko Kaplama Sac Zinc Plated Sheet Metal	0,145	766 013 111	25

BAYRAK "T" BAĞLANTI AÇI AYARLI/"T" FLAT CONNECTION (ANGLED)

M ZN

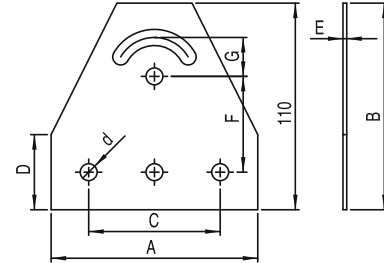
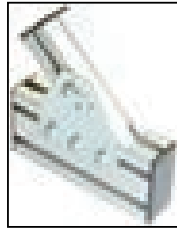

A	B	C	D	E	F	G	d	M	Kg	Stok Kod Stock Code	
110	110	80	40	2	51	20,5	M9	Çinko Kaplama Sac Zinc Plated Sheet Metal	0,140	766 013 145	25

BAYRAK "T" BAĞLANTI (110X110)/"T" CONNECTION (110X110)

M ZN

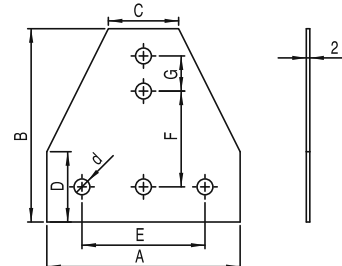
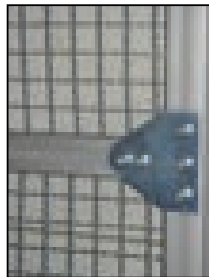
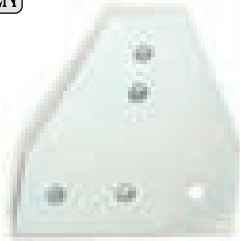



A	B	C	D	E	F	G	d	M	Kg	Stok Kod Stock Code	
110	110	40	40	61	59	30	M9	Çinko Kaplama Sac Zinc Plated Sheet Metal	0,150	766 013 112	25

*Özel üretim yapılır./On request special production is available.

KÖŞE BAĞLANTI 90 DERECE (ÜST-ALT)/SIMPLE SIDE ATTACHMENT

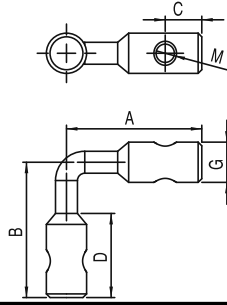
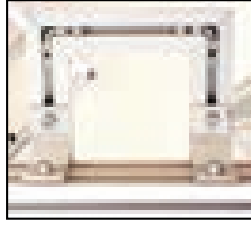
M **ZN**





	A	B	C	D	E	F	G	M	Kg	Stok Kod Stock Code	
30 x 30	19	19	12	20	M5	ø9	ø6,3	ZN	0,025	766 011 010	200
40 x 40	36	36	12,5	22	M6	ø13	ø8,0		0,050	766 012 012	
45 x 45	36	36	12,5	25	M5	ø11	ø5,5		0,036	766 012 014	

KÖŞE BAĞLANTI 90 DERECE (SAĞ-SOL)/SIMPLE FRONT ATTACHMENT

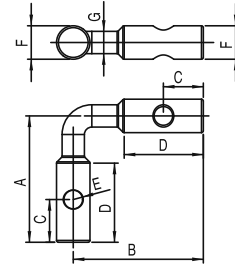
M **ZN**





	A	B	C	D	E	F	G	M	Kg	Stok Kod Stock Code	
30 x 30	19	19	12	20	M5	ø9	ø6,3	ZN	0,025	766 011 011	200
40 x 40	36	36	12,5	22	M6	ø13	ø8,0		0,050	766 011 013	
45 x 45	36	36	12,5	25	M5	ø11	ø5,5		0,036	766 112 015	

ALÜMİNYUM PROFİL ÇEKTİRME PİMİ / ALUMINIUM PROFILE DRAW-PIN

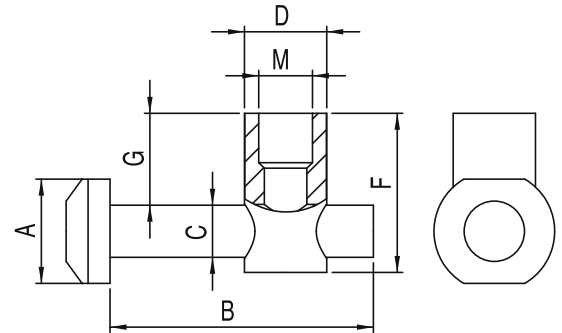
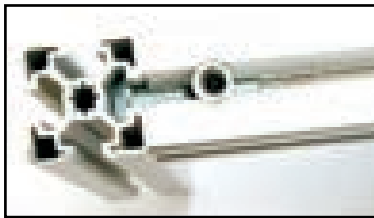
M **AL**



	A	B	C	D	F	G	M	Kg	Stok Kod Stock Code	M	
30x30 / 40x40	16	32	6	15	29	11	10	0,025	766 011 001	ZN	150
45 x 45	19	48	10	15	29	16	10	0,070	766 011 002		

*Özel üretim yapılır./On request special production is available.

KARE KANAL SOMUNLARI / NUT



1

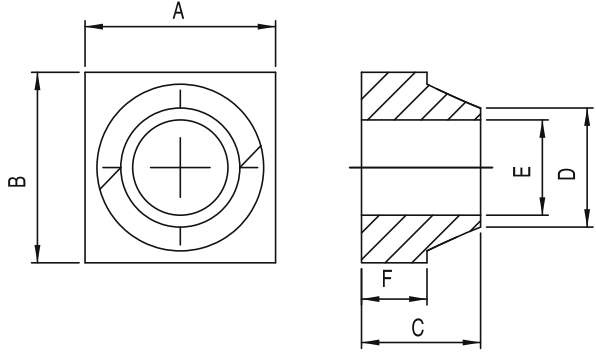

2

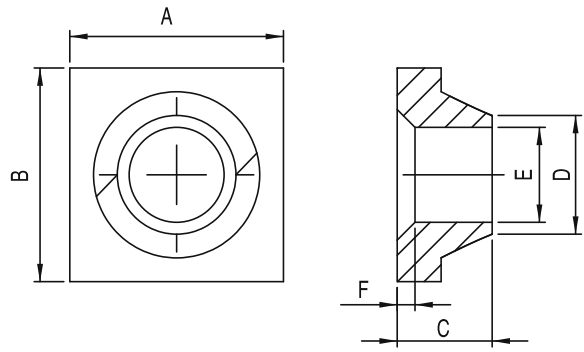

A	B	C	D	E	F	Kullanılan Profil For Profiles	M	Stok Kod Stock Code	
10	10	6	8	M5	1,7	20 x 20	Çinko Kaplı Çelik Zinc Plated Steel	766 015 001	100
12	12	6	8	M6	1,7	25 x 25		766 015 002	
16	16	6,5	9	M5	1,7	30 x 30		766 015 003	
16	16	8	12	M8	4	40 x 40		766 015 004	
18	18	8	12	M8	4	45 x 45		766 015 005	
16	16	10	12	M8	3	50 x 50		766 015 006	
18	18	6	12	M8	3	40 x 80		766 015 007	
16	16	8	12	M8	3	45 x 90		766 015 008	

YAYLI SOMUNLAR/ARC NUT



G1	G2	h	H	L	M	Kullanılan Profil For Profiles	M	Stok Kod Stock Code	
8	13	1	8	20	5	30 x 30	Çinko Kaplı Çelik Zinc Plated Steel	766 010 012	300
8	13	1	8	20	6			766 010 013	
8	13	1	8	20	8			766 010 014	

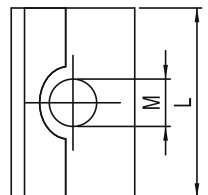
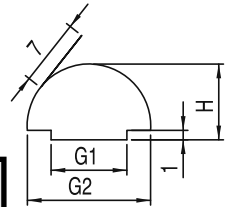

*Özel üretim yapılır./On request special production is available.

(23x129) ALÜMİNYUM GERME PLAKASI TAKIMI/(23X129) ALUMINIUM PROFILE STRECHER PLATE SET

M AL

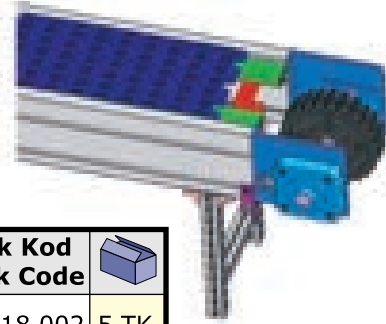

Kg	Stok Kod Stock Code	
1,350	766 018 002	5 TK

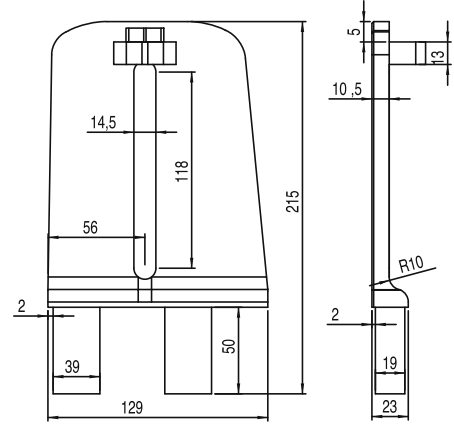

(23x129) ALÜMİNYUM TAHRİK PLAKASI TAKIMI/(23X129) ALUMINIUM PROFILE SUPPORT FOR AXIS AND BEARING PLATE SET

M AL



Kg	Stok Kod Stock Code	
1,650	766 018 001	5 TK

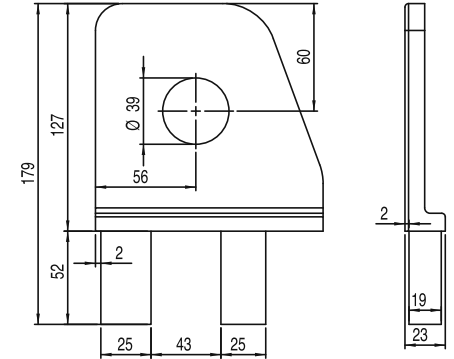

25x150 ALÜMİNYUM GERME PLAKASI TAKIMI/25 x150 ALUMINIUM PROFILE SUPPORT FOR AXIS AND BEARING PLATE SET

M AL



Kg	Stok Kod Stock Code	
2,520	766 018 003	5 TK

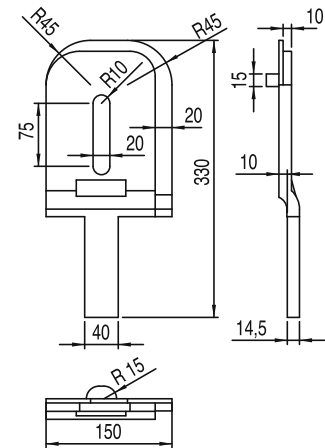

25x150 ALÜMİNYUM TAHRİK PLAKASI/25x150 ALUMINIUM PROFILE SUPPORT FOR AXIS AND BEARING PLATE SET

M AL



Kg	Stok Kod Stock Code	
2,060	766 018 004	5 TK

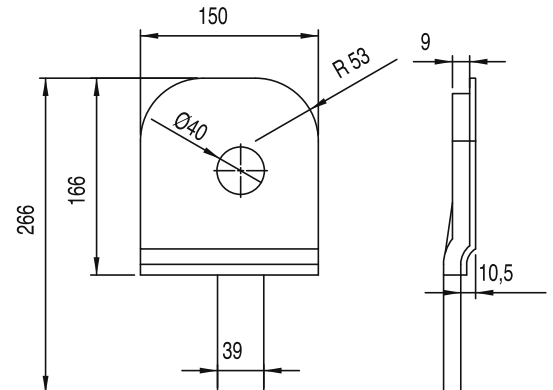

*Özel üretim yapılır./On request special production is available.

(45x45) ALÜMİNYUM PROFİL TAHRİK PLAKASI TAKIMI (SAĞ ve SOL)/(45x45) ALUMINIUM PROFILE SUPPORT FOR AXIS AND BEARING PLATE (RIGHT-LEFT)

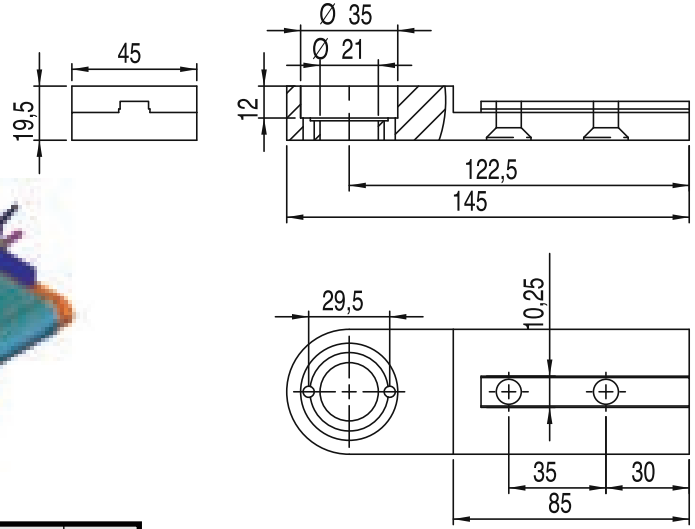
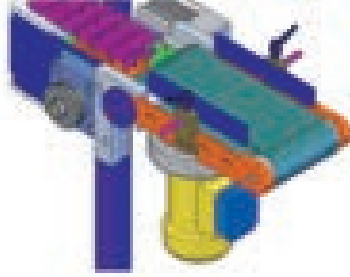

Kg	Stok Kod Stock Code	
0,390	766 018 007	20

(45x45) ALÜMİNYUM PROFİL AVARA PLAKASI TAKIMI (SAĞ ve SOL)/(45x45) ALUMINIUM PROFILE SUPPORT FOR AXIS AND BEARING PLATE (RIGHT-LEFT)



Kg	Stok Kod Stock Code	
0,340	766 018 008	20

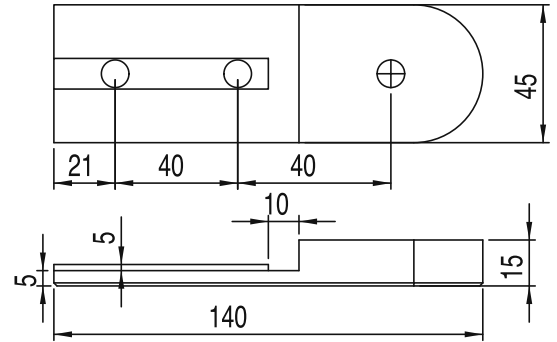
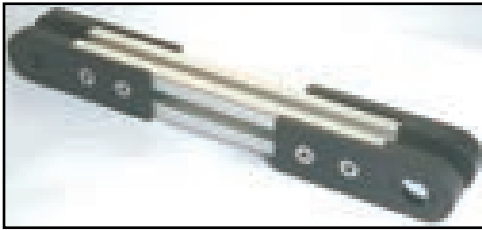

(45x45) ALÜMİNYUM PROFİL AVARA GERDİRME APARATI TAKIMI /(45x45) ALUMINIUM PROFILE SUPPORT FOR AXIS AND BEARING PLATE



Kg	Stok Kod Stock Code	
0,300	766 018 009	20

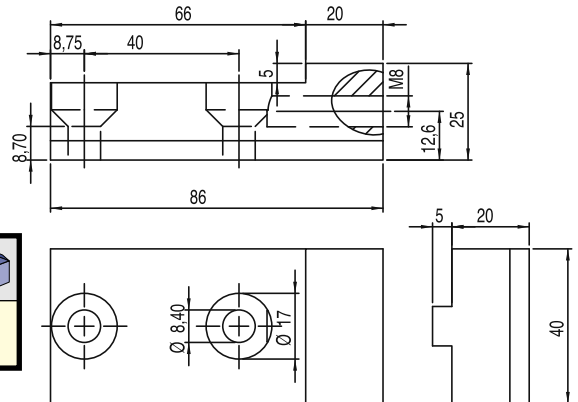

*Özel üretim yapılır./On request special production is available.

(45x90) ALÜMİNYUM AVARA PLAKASI TAKIMI (SAĞ ve SOL)/(45x90) ALUMINIUM STRECHER PLATE (RIGHT-LEFT)



Kg	Stok Kod Stock Code	
2,090	766 019 009	5 TK

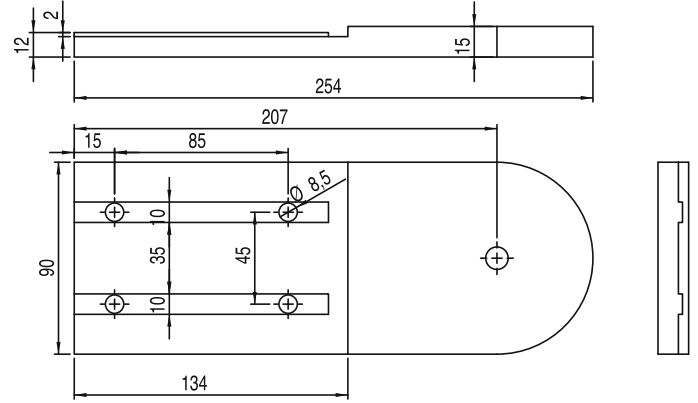

(45x90) ALÜMİNYUM PROFİL TAHRİK PLAKASI TAKIMI (SAĞ ve SOL)/(45x90) ALUMINIUM PROFILE SUPPORT FOR AXIS AND BEARING PLATE

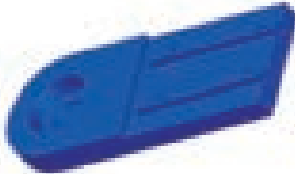

Kg	Stok Kod Stock Code	
1,835	766 019 010	5 TK

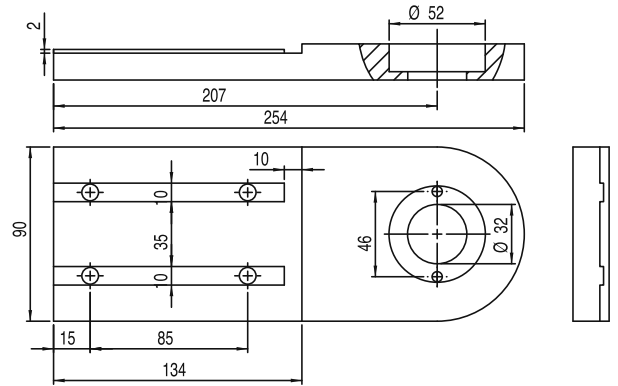

(45x90) ALÜMİNYUM PROFİL AVARA GEDİRME APARATI TAKIMI/(45x90) ALUMINIUM PROFILE SUPPORT FOR AXIS



Kg	Stok Kod Stock Code	
0,460	766 019 011	10 TK

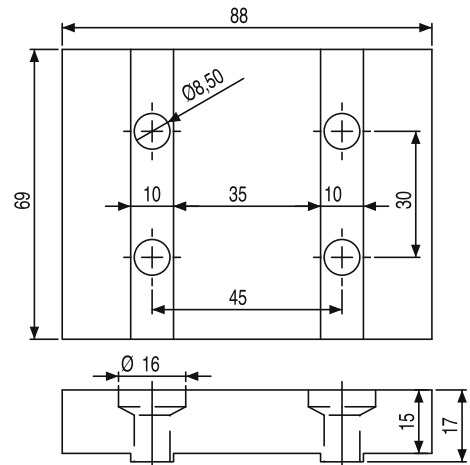



*Özel üretim yapılır./On request special production is available.

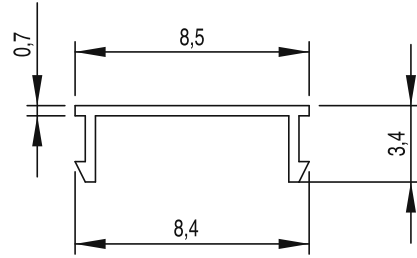
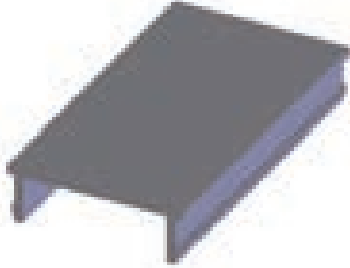

ALÜMİNYUM PROFİL KANAL FİTİLİ (8)/ALUMINIUM STRIP PROFILE (8)

M AL



Kullanıldığı Profiller/For Profile	M	Kg/m	Stok Kod Stock Code	
(30X30) (23X127) (25X105)	PVC Siyah/Black	0,021	766 016 001	3 Metre
(25X115) (50X88) (50X118)	PVC Beyaz/White	0,021	766 016 011	

ALÜMİNYUM PROFİL KANAL FİTİLİ (10)/ALUMINIUM STRIP PROFILE (10)

M AL

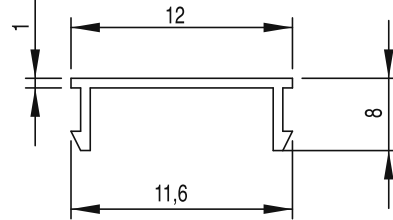
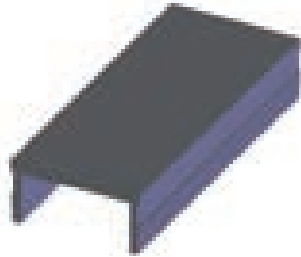

Kullanıldığı Profiller/For Profile	M	Kg/m	Stok Kod Stock Code	
(45X45) (45X90) (50X50)	PVC Siyah/Black	0,034	766 016 002	3 Metre
	PVC Beyaz/White	0,034	766 016 012	

ALÜMİNYUM PROFİL KANAL FİTİLİ (10)/ALUMINIUM STRIP PROFILE (10)

M AL

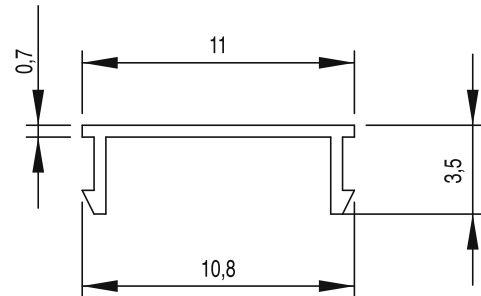
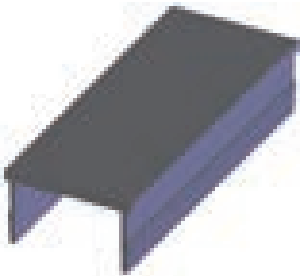

Kullanıldığı Profiller/For Profile	M	Kg/m	Stok Kod Stock Code	
(40X40) (45X90) (50X50)	PVC Siyah/Black	0,034	766 016 003	3 Metre
	PVC Beyaz/White	0,034	766 016 013	

*Özel üretim yapılır./On request special production is available.

20x20 PLASTİK PROFİL KAPAĞI/20X20 PLASTIC PROFILE COVER

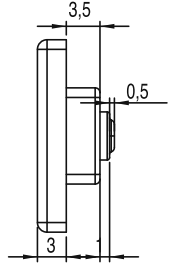
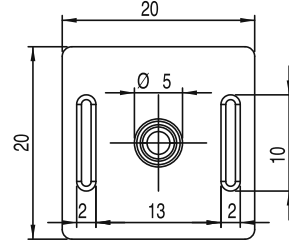

Kg	Stok Kod Stock Code	M	
0,002	766 014 020	Güçlendirilmiş Polyamid Reinforced Polyamide (PA6)	200

25x25 PLASTİK PROFİL KAPAĞI/25X25 PLASTIC PROFILE COVER

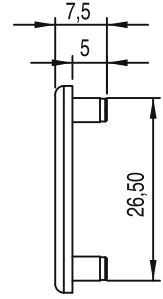
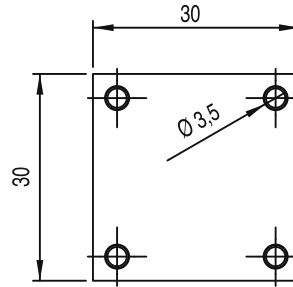

A	B	C	D	E	F	G	Kg	Stok Kod Stock Code	M	
25	25	19	5	3	7	9,5	0,003	766 014 025	Güçlendirilmiş Polyamid Reinforced Polyamide (PA6)	150

ALÜMİNYUM PROFİL KAPAĞI/ALUMINIUM PROFILE COVER



	Kg	Stok Kod Stock Code	M	
30 X 30	0,003	766 014 030	Güçlendirilmiş Polyamid Reinforced Polyamide (PA6)	150
40 X 40	0,008	766 014 040		150
45 X 45	0,011	766 014 045		120
50 X 50	0,013	766 014 050		100

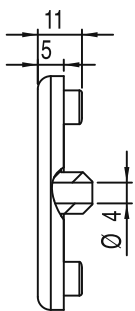
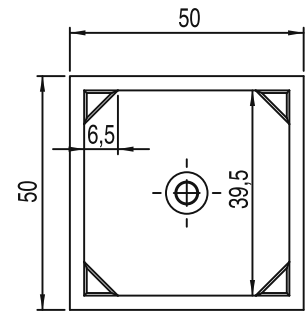

45x90 ALÜMİNYUM PROFİL KAPAĞI/45X90 ALUMINIUM PROFILE COVER



Kg	Stok Kod Stock Code	M	
0,022	766 014 590	Güçlendirilmiş Polyamid Reinforced Polyamide (PA6)	100

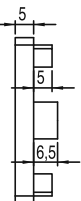
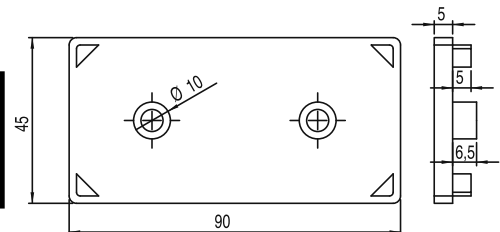

*Özel üretim yapılır./On request special production is available.

PLASTİK KÖŞE BAĞLANTI (30X30)/SIDE CONNECTION (PLASTIC)

M PA



M	A	Kg	Stok Kodu Stock Code	
Güçlendirilmiş Polyamid PA6 Reinforced Polyamide	10	0,03	766 211 010	120
	8	0,03	766 111 008	120

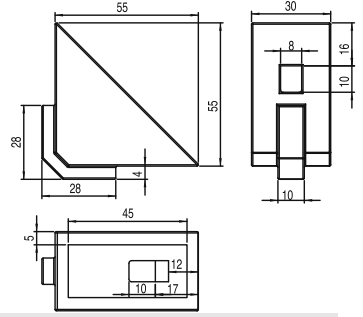

PLASTİK KÖŞE BAĞLANTI (45X45)/SIDE CONNECTION (PLASTIC)

M PA

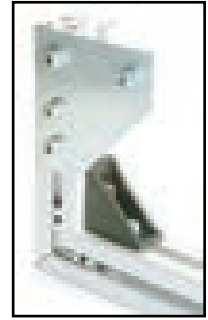
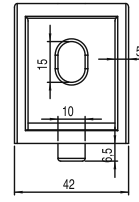
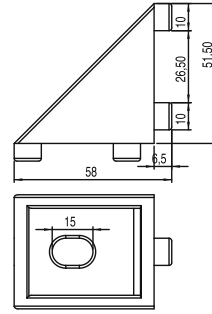
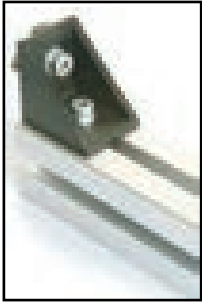

M	Kg	Stok Kodu Stock Code	
Güçlendirilmiş Polyamid PA6 Reinforced Polyamide	0,040	766 311 010	80

ZAMAK KÖŞE BAĞLANTI/BRACKET

M ZA

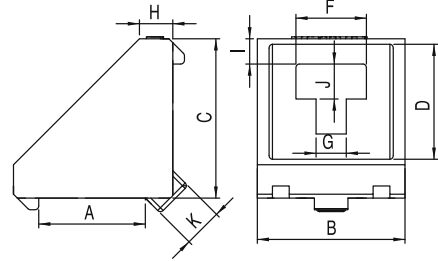

	A	B	C	D	E	F	G	H	I	J	K	M	Kg	Stok Kodu Stock Code	
40 x 40	31	38	41	29,5	30	19,5	9	8,5	5,5	9	10	ZA	0,14	766 011 015	80
45 x 45	31	44	41	29,5	37	21	9	8,5	5,5	9	10		0,15	766 011 016	

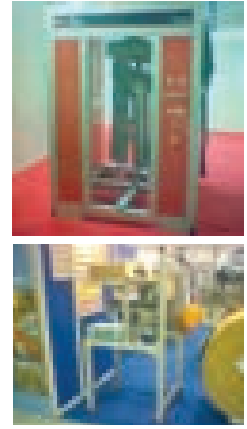
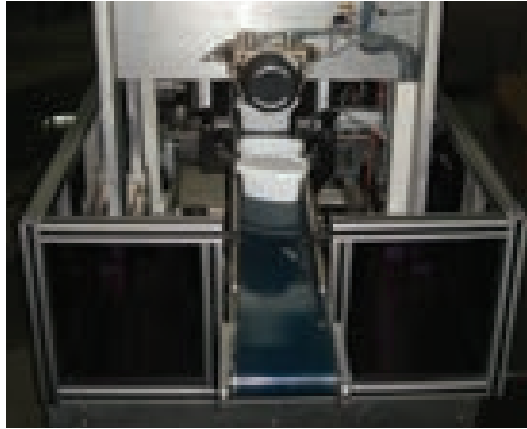

*Özel üretim yapılır./On request special production is available.

RULOLU KONVEYÖRLER İÇİN RULO TUTUCU/ROLL HOLDER FOR ROLLER CONVEYOR

M PA

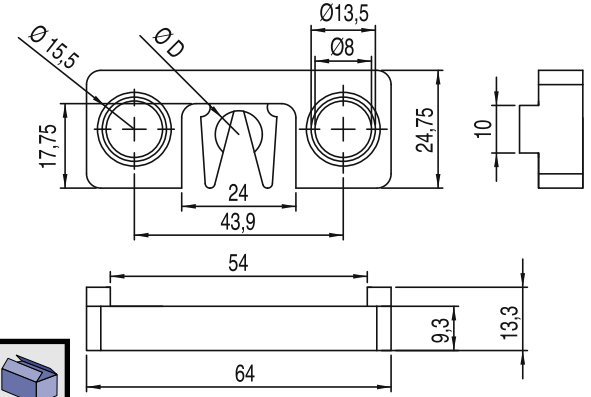

Kullanılan Profil For Profiles	øD	M	Kg	Stok Kodu Stock Code	
40 x 40 - 45 x 45	8	Güçlendirilmiş Polyamid Reinforced Polyamide	0,10	766 RUT 008	50
45 x 90 - 50 x 50	10			766 RUT 010	
	12			766 RUT 012	

SİGMA PROFİL AYAK İÇİN PLASTİK BAĞLANTI/SIDE SUPPORT

M PA

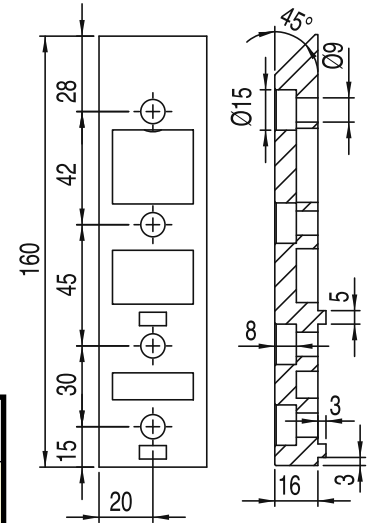
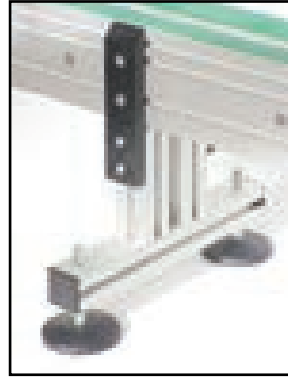

Kullanılan Profil For Profiles	L	L1	L2	L3	M	Kg	Stok Kodu Stock Code	
Sigma	160	46	42	28	Güçlendirilmiş Polyamid Reinforced Polyamide	0,10	766 SBP 001	75

ZAMAK KÖŞE BAĞLANTI 30x30/BRACKET

M AL

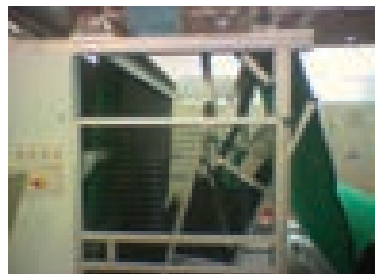
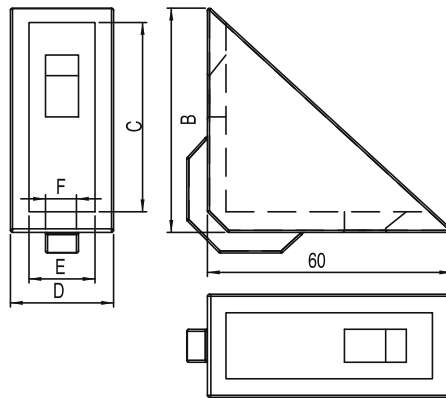

A	B	C	D	E	F	G	M	Kg	Stok Kodu Stock Code	
60	55	46	25	19	8	27	Alüminyum/Aluminium	0,12	766 011 003	80
60	55	46	25	19	10	27		0,12	766 011 012	80

*Özel üretim yapılır./On request special production is available.



ÇAĞRI[®]
ENDÜSTRİ A.Ş.

ALHAN[®]

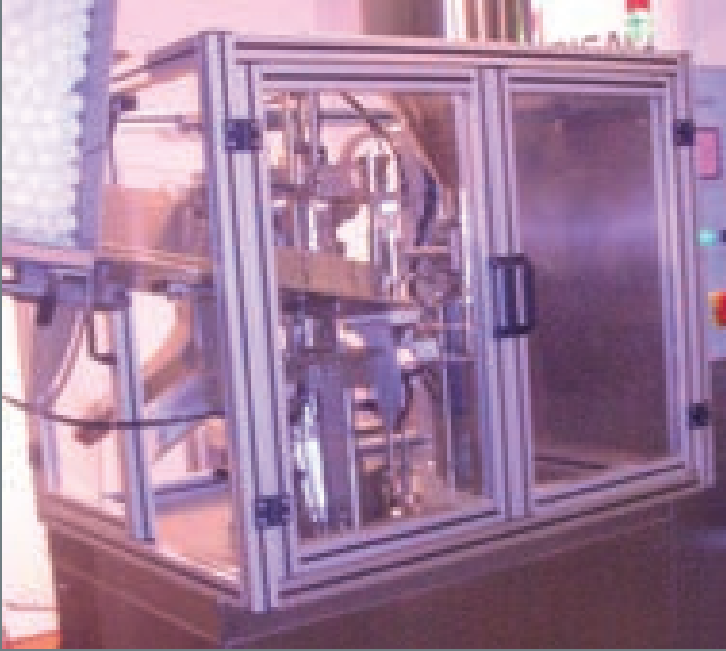
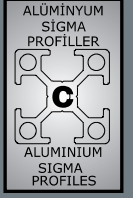



ÇAĞRI[®]
ENDÜSTRİ A.Ş.

ALHAN[®]

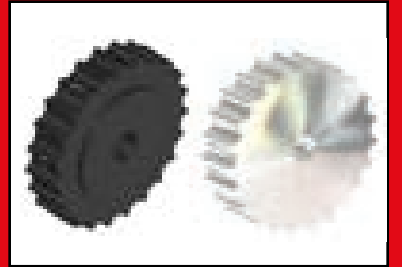
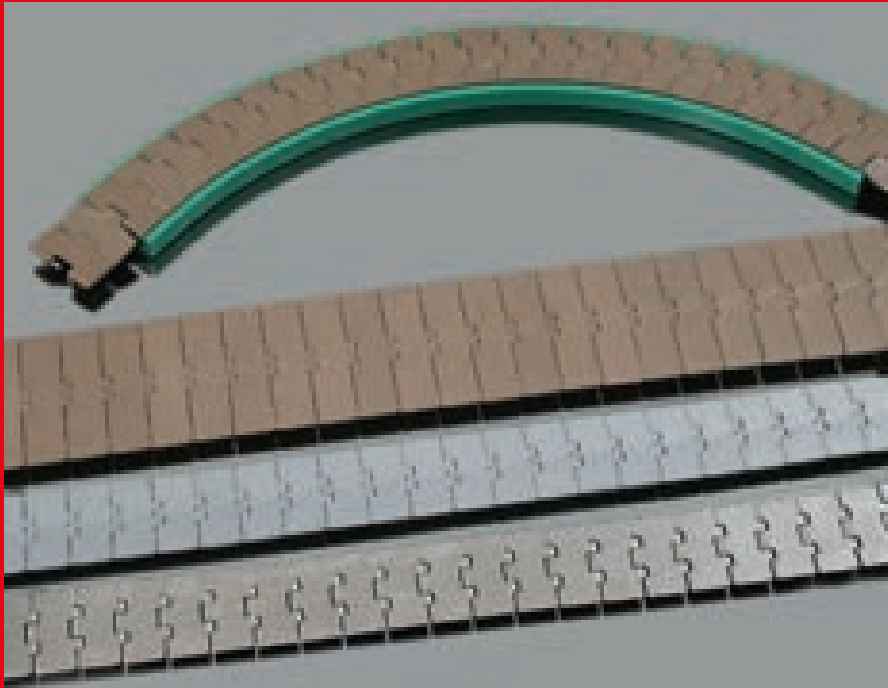
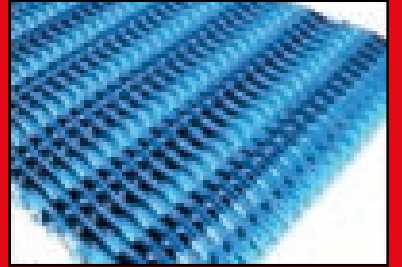
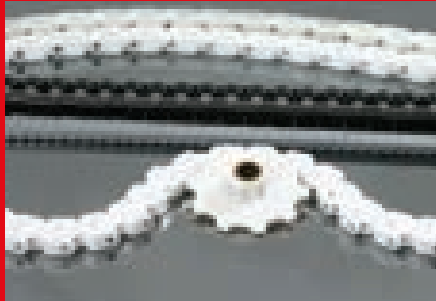

**Düşük Sürtünmeli Asetal/Low Friction Acetal (LF)**

Termoplastik grubundan olan bu malzeme düşük sürtünme katsayısı ve yüksek gerilme değerlerine sahiptir. Dönüşlü ve düz konveyör bantlarında kullanılan bu malzemenin gıdaya uygunluk belgesi bulunmaktadır.

This is a thermoplastic material with special additives providing low coefficients and high tensile strength. This material's specific components make it ideally suited for use in curved-route chains. Material with certificate FDA.

Asetal/Acetal(D)

Oldukça yüksek mekanik özelliklere sahiptir. İçerik olarak herhangi bir katkı maddesi bulunmamakla birlikte gıdaya uygunluk sertifikası bulunmaktadır.

This thermoplastic has extremely good mechanical properties. It is used without any special additives. Material with certificate FDA.

Güçlendirilmiş Polipropilen/Reinforced Polypropylene (PP+FV)

Cam elyaf katkılı polipropilendir. Kimyasallara karşı dayanımı yüksektir.

Fibre-glass reinforced polypropylene. This material is highly resistant to chemical agents.

Polyamid/Polyamide(PA6)

Yüksek gerilme özelliğine sahip olan bu malzemenin ses azaltıcı özelliği bulunmaktadır.

This material has high tenacity and good noise absorption polyamide.

Güçlendirilmiş Polyamid/Reinforced Polyamide

Cam elyaf katkılı olan bu malzemenin mekanik ve ısıl özellikleri artırılmıştır.

Polyamide variant with mechanical and thermal properties improved.

Alpolen®UHMW

Yüksek moleküler ağırlığa sahip olan alpolen düşük sürtünme katsayısı ile sürtünme profilleri ve zincir kızıkları elemanlarında kullanılmaktadır. Gıdaya uygunluk sertifikası bulunmaktadır.

The ultra high molecular weight alpolen is the material more used in friction applications in view of its piece-quality relation. It can be used in sliding guides and friction profiles.

PBT

Normal şartlar altında su geçirgenliği neredeyse sıfır olan bu malzemenin mekanik ve ısıl özellikleri de oldukça yüksektir. Daha çok rulman yataklarında kullanılmaktadır.

It has high water absorption furthermore good mechanical and thermal properties.

Katalogtaki ürünlerin tasarımları değişikliğe uğrayabilir ve değişiklikten doğabilecek sorunlardan firmamız sorumlu değildir. In catalogue, our product's design will be changed and as a result of this we have no response.

**PASLANMAZ BANT MALZEMELERİ VE ÖZELLİKLERİ/STAINLESS STEEL CHAIN PROPERTIES****A INOX 18/8 (%18 KROM, %8 NİKEL) AISI 304 (SSS)**

Austenit ve magnetik olmayan AISI 304 paslanmaz çelik (%18 krom, %8 nikel), zor koşullara uygun, yüksek dirençli, kimyasal etkilere ve korozyona karşı mükemmel direnç gösterir. Kusursuz mekanik ve karakteristik ömrüne sahiptir. Gıda ve şişeleme sektöründe kullanıma uygundur.

Chrome-nickel, austenitic AISI 304 stainless steel slats (18% Chrome - 8% Nickel), work hardened for high resistance - shiny with a roughness of Ra < 0,5 microns.

Chrome-nickel, austenitic stainless steel pins and guide shoes (18% Chrome - 8% Nickel), work hardened for high resistance.

Max. Dayanıklılık/Max Resistance: 10000 N

Çalışma Yüğü/Working Load : 5500 N (düzgün doğrusal/linear)

Max. Dayanıklılık/Max Resistance: 9400 N

Çalışma Yüğü/Working Load : 5500 N (dönüştü/rounding)

Sertlik/Hardness: 28-30 HRC Pürüzlülük/Roughness <0,3 micron

B INOX (%17 KROM) AISI 430 (SSC)

Demire bağlı, AISI 430 paslanmaz çelik, soğuk çalışmada zor koşullara uygun, korozyona karşı dayanımı çok iyi, düşük sürtünmeli, mükemmel yüzey tamamlayıcı, konveyör ürünlerinde sürtünmedeki kalitesi onaylı özellikle şişeleme endüstrisinde kullanılır.

Ferritic, AISI 430 stainless steel slats, work hardened, with shiny surface having low roughness.

Chrome-nickel, austenitic stainless steel pins (18% Chrome - 8% Nickel), work hardened for high resistance.

Max. Dayanıklılık/Max Resistance: 7600 N

Çalışma Yüğü / Working Load: 4950 N

Sertlik/Hardness: 18-20 HRC

Pürüzlülük / Roughness <0,3 micron

C HARD INOX (%17 KROM, %2 NİKEL) HI

Özel, zor koşullara uygun, krom-nikel, yüksek dayanım ve korozyona dayanıklı, paslanmaz çelik, mükemmel mekanik özelliklere sahip, çok düşük yüzey pürüzlülüğünden dolayı özel bir kayganlığa sahiptir.

Special, chrome-nickel, stainless steel slats, work hardened for high resistance, with shiny surface having a roughness of Ra <0,3 microns.

Chrome-nickel, austenitic stainless steel pins and guide shoes (18% Chrome - 8% Nickel), work hardened for high resistance.

Max. Dayanıklılık/Max Resistance: 10000 N

Çalışma Yüğü/Working Load : 5500 N (düzgün doğrusal/linear)

Max. Dayanıklılık/Max Resistance: 9400 N

Çalışma Yüğü/Working Load : 5500 N (dönüştü/rounding)

Sertlik/Hardness: 30-32 HRC Pürüzlülük/Roughness <0,3 micron

D KARBON ÇELİĞİ/CARBON STEEL (43 HRC)

Yüzeyinde ve çekirdek sertliğinde 43 HRC içeren ısıtma işlemi karbon çeliğidir. Özellikle aşırı çalışma yüklerinde çok uygundur ve yüksek aşınma direncine sahiptir. Cam, seramik ve genel üretim endüstrisi konveyör sistemlerinde kullanılır.

Heat-treated carbon steel slats, with a surface and core hardness of 43 HRC.

Case hardened carbon steel pins.

Max. Dayanıklılık/Max Resistance: 12000 N

Çalışma Yüğü/Working Load : 6000 N (düzgün doğrusal/linear)

Max. Dayanıklılık/Max Resistance: 11000 N

Çalışma Yüğü/Working Load : 6000 N (dönüştü/rounding)

E AISI 316 (%17 Cr, %11,5 Ni, %2,5 Mo)

AISI 316 mükemmel asit dayanımı sayesinde, asitli uygulamalarda son derece başarılıdır. Bizim zincirlerimizde güçlendirilmiş polipropilen malzeme ile kullanılır. Austenitik paslanmaz ailesine aittir.

Stainless steel variant with superior acid resistance Used in some of our chains in polypropylene + glass fiber.

Gerilim/ Tensile : 510 - 710 Nt/mm²

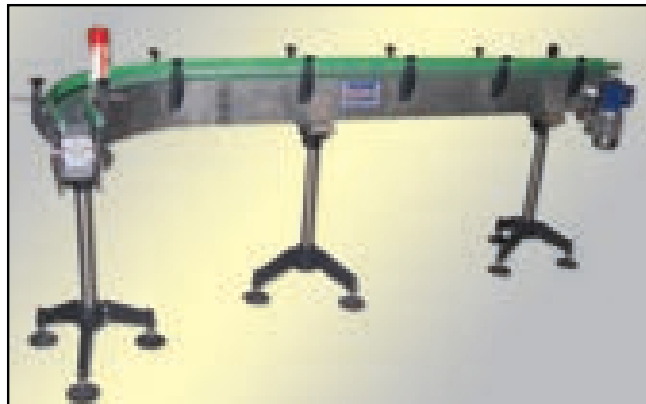

815 DÜZGÜN DOĞRUSAL PASLANMAZ BANTLAR (AISI 304) (AISI 430) / PLATE CHAINS (AISI 304) (AISI 430)

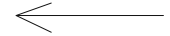
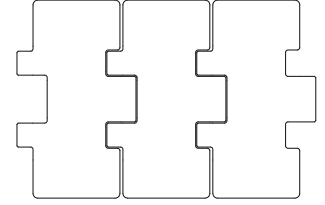
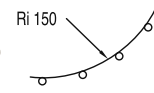
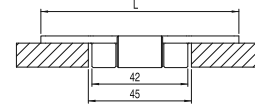
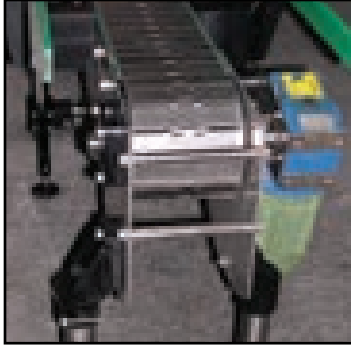

mm							
P	PIN	L	M	Kg/m	Stok Kod Stock Code	Metre/Meter (m)	Feet (ft)
38,1	Paslanmaz Çelik Stainless Steel AISI 304	82,6	Paslanmaz Çelik (AISI 304) Stainless Steel (AISI 304)	2,65	815 304 082	3,048	10
		88,9		2,70	815 304 088		
		101,6		3,00	815 304 101		
		114,3		3,30	815 304 114		
		152,4		4,20	815 304 152		
		190,5		5,10	815 304 190		
		82,6		Paslanmaz Çelik (AISI 430) Stainless Steel (AISI 430)	2,65		
		88,9	2,70	815 430 088			
		101,6	3,00	815 430 101			
		114,3	3,30	815 430 114			
		152,4	Paslanmaz Çelik (AISI 316*) Stainless Steel (AISI 316*)	4,20	815 430 152		
		190,5	5,10	815 430 190			

*Özel üretim yapılır. / On request by manufactured. E AISI 316 → 815 316 ... C HARD INOX → 815 OHI ...

810 PASLANMAZ ÇELİK BANT/PLATE CHAINS

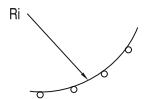
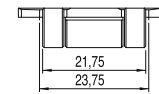
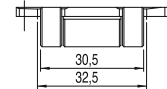
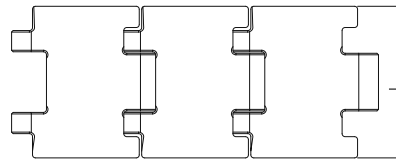



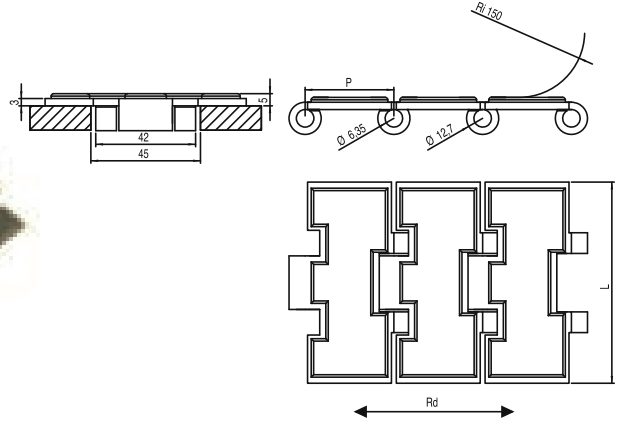
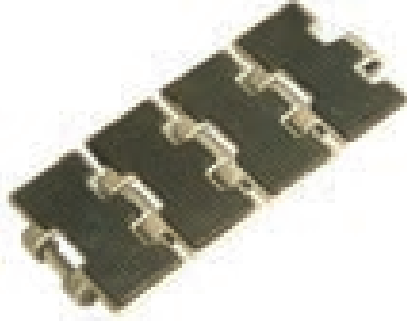

mm								
Ri	PIN	P	L	M	Kg/m	Stok Kod Stock Code	Metre/Meter (m)	Feet (ft)
75	Paslanmaz Çelik Stainless Steel AISI 304	38,1	31,8	Paslanmaz Çelik (AISI 304) Stainless Steel (AISI 304)	1,10	810 304 031	3,048	10
75			44,5		1,30	810 304 044		
90			50		1,60	810 304 050		
75			Paslanmaz Çelik (AISI 430) Stainless Steel (AISI 430)	31,8	1,10	810 430 031		
75				44,5	1,30	810 430 044		
90				50	1,60	810 430 050		
75			Paslanmaz Çelik (HI) Stainless Steel (HI)	31,8	1,10	810 OHI 031		
75				44,5	1,30	810 OHI 044		
90				50	1,60	810 OHI 050		

*Özel üretim yapılır./On request special production is available.

815 G KAUCUK KAPLI PASLANMAZ KULAKSIZ BANT (AISI 304)/PLATE CHAINS WITH RUBBER TOP



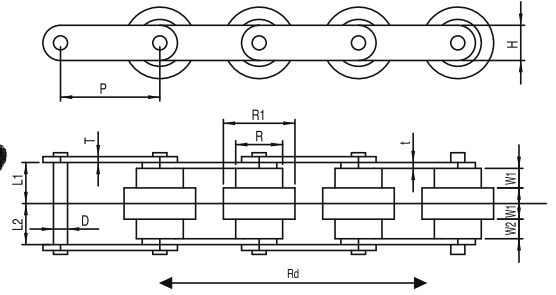
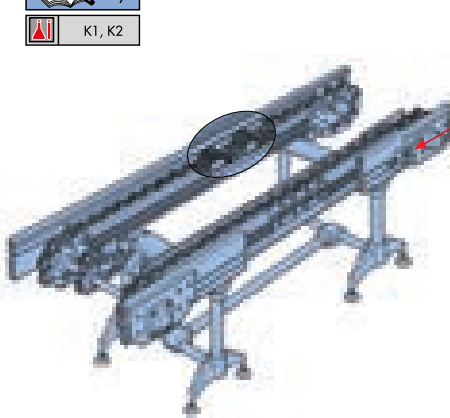

mm								
Ri	P	L	 	PIN	Kg/m	Stok Kod Stock Code	Metre/Meter (m)	Feet (ft)
150	38,1	82,6	Paslanmaz Çelik Stainless Steel (AISI 304)   Say.2	Paslanmaz Çelik Stainless Steel AISI 304	2,65	815 OHI G82	3,048	10

808 MAKARALI ZİNCİR BANTI/ROLLER CHAIN



Uygulama alanları/Applications
-T.V. ve Buzdolabı son montaj hattında
-T.V. and Refrigerator end of the assembly line



mm															
P	R	R1	W1	W2	t	T	H	D	L1	L2	 	Kg/m	Stok Kod Stock Code	Metre/Meter (m)	Feet (ft)
38.10	22.23	36.6	15.5	8.5	3.2	3.2	17.2	5.96	24.5	26.4	Güçlendirilmiş Polyamid Reinforced Polyamide	2,4	808 RUL 038	3.048	10
50.80	28.58	48.0	20.0	15.0	4.0	4.0	23.0	7.94	35.8	38.0		4,3	808 RUL 050	3.048	

PIN: Paslanmaz Çelik/Stainless Steel (AISI 304)



Güçlendirilmiş poliasetal siparişleriniz için lütfen stok kodunun sonuna "G" ekleyiniz.
For request of reinforced polyamide, you can add "G" the end of the code number.

*Özel üretim yapılır./On request special production is available.

805 ÇİFT MENTEŞELİ ÇELİK BANTLAR/DOUBLE HINGES PLATE CHAINS

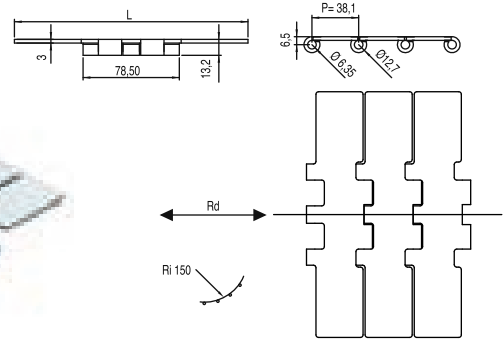
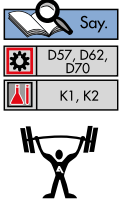

mm							
RM	PIN	L		Kg/m	Stok Kod Stock Code	Metre/Meter (m)	Feet (ft)
-	Paslanmaz Çelik Stainless Steel AISI 304	190,5	Paslanmaz Çelik (HI) Stainless Steel (HI) Say.2	5,80	805 OHI 190	3,048	10
			Paslanmaz Çelik (43 HRC) Stainless Steel (43 HRC) Say.2		805 HRC 190		
			Paslanmaz Çelik (304 AISI) Stainless Steel (304 AISI) Say.2		805 304 190		
			Paslanmaz Çelik (430 AISI) Stainless Steel (430 AISI) Say.2		805 430 190		

881 M DÖNÜŞLÜ PASLANMAZ BANT (MANYETİK)/PLATE CHAINS FOR CURVED CONVEYORS (MAGNETIC)

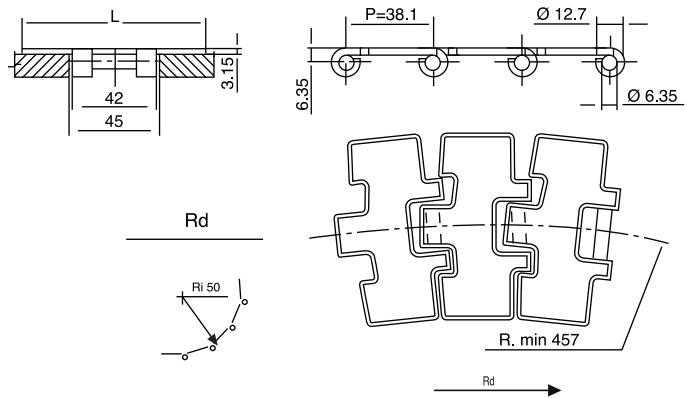

mm							
RM	PIN	L		Kg/m	Stok Kod Stock Code	Metre/Meter (m)	Feet (ft)
457	Özel Paslanmaz Stainless Steel	82,6	Paslanmaz Çelik HI Stainless Steel HI Say.2	2,50	881 OHI M08	3,048	10
457		114,3		3,20	881 OHI M11		
610		190,5		4,90	881 OHI M19		

*Özel üretim yapılır./On request special production is available.

881 TAB-KULAKLI DÖNÜŞLÜ BANT/PLATE CHAINS FOR CURVED CONVEYORS

Say.
D55, D63 D65, D71
K1, K2

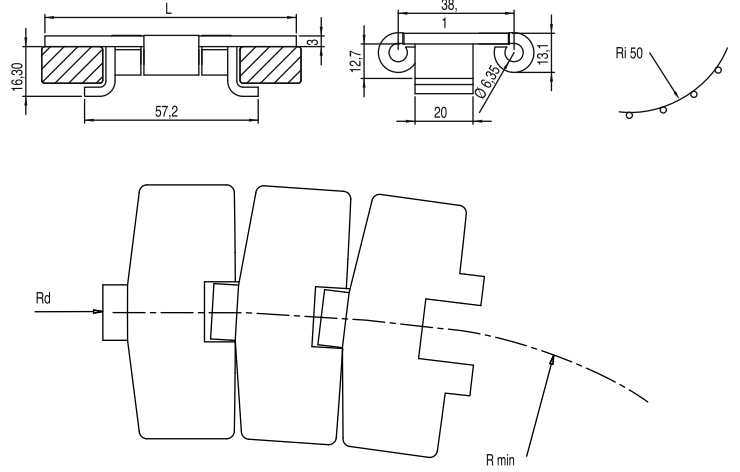

mm							
L	RM		PIN	Kg/m	Stok Kod Stock Code	Metre/Meter (m)	Feet (ft)
82,6	457	Paslanmaz Çelik(AISI 304) Stainless Steel (AISI 304)	Paslanmaz Çelik Stainless Steel AISI 304	3,10	881 304 T08	3.048	10
114,3	550			3,80	881 304 T11		
190,5	610			Say.2	5,50		
82,6	457	Paslanmaz Çelik (HI) Stainless Steel (HI)	Paslanmaz Çelik Stainless Steel AISI 304	3,10	881 OHI T08		
114,3	550			3,80	881 OHI T11		
190,5	610			Say.2	5,50		

881 AÇILI KULAKLI DÖNÜŞLÜ PASLANMAZ BANT (8°)/PLATE CHAINS FOR CURVED CONVEYORS (8°)

Say.
D55, D63 D65, D71
K1, K2

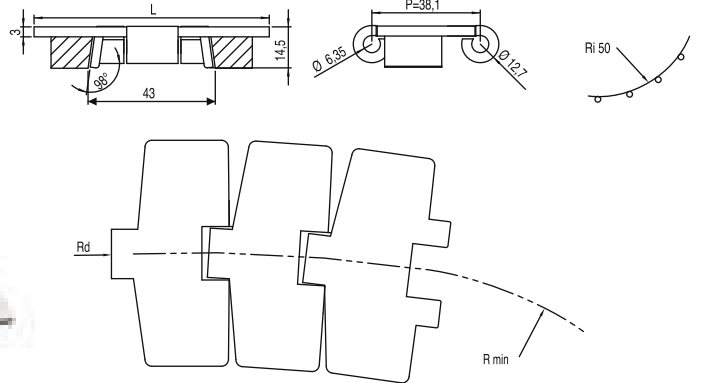

mm							
L	RM		PIN	Kg/m	Stok Kod Stock Code	Metre/Meter (m)	Feet (ft)
82,6	457	Paslanmaz Çelik(AISI 304) Stainless Steel (AISI 304)	Paslanmaz Çelik Stainless Steel AISI 304	3,10	881 304 O08	3.048	10
114,3	550			3,80	881 304 O11		
190,5	610			Say.2	5,50		
82,6	457	Paslanmaz Çelik (HI) Stainless Steel (HI)	Paslanmaz Çelik Stainless Steel AISI 304	3,10	881 OHI O08		
114,3	550			3,80	881 OHI O11		
190,5	610			Say.2	5,50		

*Özel üretim yapılır./On request special production is available.

PASLANMAZ BANT SEÇİMİ/CHOICE OF STAINLESS STEEL CHAIN
Semboller/Symbols

F_t	: Tahrik bölümündeki bant kuvveti/Chain tension at headshaft (N)
F_0	: Dönüş tahrik bölümündeki bant kuvveti/Chain tension on return track (N)
F_1, F_2, \dots	: Toplam yüklemesi/Sum of all loads (N)
W_c	: Bant ağırlığı/Chain weight (Kg/m)
W_m	: Taşınacak malzeme ağırlığı/Conveyed product weight (Kg/m)
L	: Yatay konveyör uzunluğu/Horizontal conveyor length (meters)
L_1, L_2, \dots	: Tahrikli mesafe/Conveyor track length (meters)
H	: Konveyör (çıkış) yüksekliği/Vertical conveyor elevation (meters)
L_s	: Kesiti alınmış olan konveyör uzunluğu Conveyor length of the section where accumulation occurs (meters)
L_{1s}, L_{2s}, \dots	: Kesiti alınmış olan konveyör uzunluğu Conveyor length of the section where accumulation occurs (meters)
R	: Dönüş yarıçapı/Curve radius (meters)
α	: Eğim açısı/Bending angle (degrees)
K	: Uzunluk faktörü/Length factor (tablo/table D)
T	: Dönüş faktörü/Curve factor (tablo/table E)
f_1	: Bant ile yataklama profili arasındaki sürtünme faktörü Friction factor between chain and wear strips (tablo/table A)
f_2	: Bant ile taşınacak malzeme arasındaki sürtünme faktörü Friction factor between chain and conveyed products (tablo/table A)
f_p	: Çalıştırma faktörü/Start up factor (tablo/table B)
S	: Kayma faktörü/Slippage factor (tablo/table C)
9.81	: Yer çekimi ivmesi/Gravity acceleration (m/s ²)

Bant malzemesi/Chain materials:
Karbon çeliği ve paslanmaz çeliği/Carbon steel and stainless steel

A	f_1		f_2		
	Bant ile yataklama profili arasındaki sürtünme faktörü Friction factor between chain and wear strips		Bant ile taşınacak malzeme arasındaki sürtünme faktörü Friction factor between chain and conveyed products		
Yağlama durumu Lubrication used	Çelik Steel	Yüksek yoğunluklu polietilen High density polyeth.	Plastik plastic	Metal Metal	Cam, seramik Glass, ceramic
Kuru/Dry	0,50	0,20	0,30	0,45	0,45
Su/Water	0,40	0,15	0,25	0,40	0,40
Sabunlu su/Soapy water	0,20	0,12	0,15	0,20	0,25
Yağ/Oil	0,20	0,08	-	0,15	0,20

B	Çalıştırma faktörü Start up factor
Saatteki çalıştırılma Start ups per hour	f_p
0	1,0
5	1,4
10	1,7
15	1,8
20	1,9
25	2,0

D	K	T			
		Dönüş faktörü/ Curve factor			
Eğim açısı Bending angle	Uzunluk faktörü Length factor	Çelik yataklama profili Steel wear strips		Yüksek yoğunluklu polietilen yataklama profili High density polyeth. wear strips	
Derece/Degrees α		Kuru/Dry	Yağlı/Lubricated	Kuru/Dry	Yağlı/Lubricated
15	0,25	1,20	1,05	1,10	1,05
30	0,52	1,30	1,10	1,20	1,10
45	0,79	1,40	1,20	1,30	1,20
60	1,05	1,60	1,30	1,50	1,25
90	1,57	2,00	1,50	1,80	1,35
120	2,09	2,50	1,70	2,20	1,50
150	2,62	3,10	1,90	2,70	1,75
180	3,14	3,50	2,10	3,00	1,90

C	Kayma faktörü Slippage factor
Kayma zamanı oranı Slippage time percentage	S
0	0
10	0,5
20	0,7
30	0,8
40	0,9
50 >	1,0

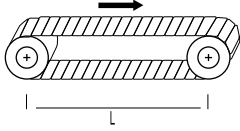
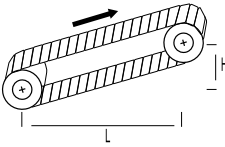
PASLANMAZ BANT SEÇİMİ/CHOICE OF STAINLESS STEEL CHAIN
**Yatay Konveyör
Horizontal conveyor**

**Eğimli Konveyör
Inclined conveyor**

**Doğrusal bant kullanılan konveyörlerde F_t 'nin bulunması
Conveyors with straight running chains**

$$F_t = (2W_c + W_m) \times L \times f_1 \times f_p \times 9,81$$

$$F_t = [(2W_c + W_m) \times L \times f_1 \times f_p + L_s \times W_m \times f_2 \times S] \times 9,81$$

$$F_t = [(2W_c + W_m) \times L \times f_1 \times f_p + (W_c + W_m) \times H] \times 9,81$$

$$F_t = [(2W_c + W_m) \times L \times f_1 \times f_p + (W_c + W_m) \times H] \times 9,81$$

Eşitliklerin sonucunda/As a result of equations

$$F_t = [(2W_c + W_m) \times L \times f_1 \times f_p + (W_c + W_m) \times H + L_s \times W_m \times f_2 \times S] \times 9,81$$

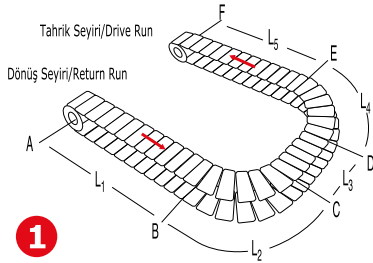
**Dönüşlü bant kullanılan konveyörlerde F_t 'nin bulunması 1
Conveyors with sidelflexing chains 1**

Tahrik bölümündeki bant kuvvetlerinin toplamı sonuçundaki eşitlik toplam yüklemeyi verecektir.
In this case the calculation of the chain tension at headshaft is carried out as the sum of successive loads

$$L_2 = K(\alpha_2) \times R_2$$

$$L_4 = K(\alpha_4) \times R_4$$

Dönüş Seyiri/Return Run 2

$$FE \quad F_5 = W_c \times L_5 \times f_1$$

$$FD \quad F_4 = [F_5 + W_c \times L_4 \times f_1] \times T(\alpha_4)$$

$$FC \quad F_3 = F_4 + W_c \times L_3 \times f_1$$

$$FB \quad F_2 = [F_3 + W_c \times L_2 \times f_1] \times T(\alpha_2)$$

$$FA \quad F_0 = F_1 + f_p \times 9,81$$

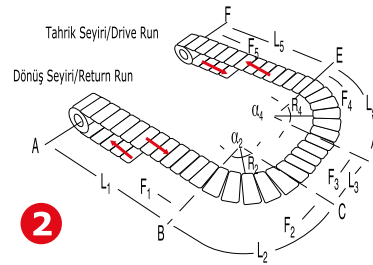

$$F_0 = \{ [(L_5 + L_4) \times W_c \times f_1 \times T(\alpha_4) + (L_3 + L_2) \times W_c \times f_1] \times T(\alpha_4) + L_1 \times W_c \times f_1 \} \times f_p \times 9,81$$

Tahrik Seyiri/Drive Run 3

$$AB \quad F_1 = F_0 + (W_c + W_m) \times L_1 \times f_1 + f_p \times 9,81$$

$$AC \quad F_2 = [F_1 + (W_c + W_m) \times L_2 \times f_1 + f_p \times 9,81] \times T(\alpha_2)$$

$$AD \quad F_3 = F_2 + (W_c + W_m) \times L_3 \times f_1 + f_p \times 9,81$$

$$AE \quad F_4 = [F_3 + (W_c + W_m) \times L_4 \times f_1 + f_p \times 9,81] \times T(\alpha_4)$$

$$AF \quad F_5 = F_4 + (W_c + W_m) \times L_5 \times f_1 + f_p \times 9,81$$

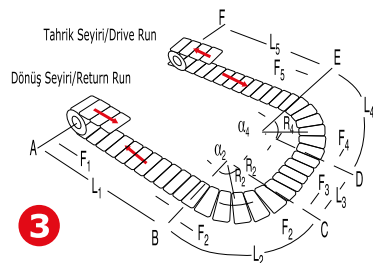

$$AB \quad F_1 = F_0 + [(W_c + W_m) \times L_1 \times f_1 \times f_p + L_{1S} \times W_m \times f_2 \times S] \times 9,81$$

$$AC \quad F_2 = \{ F_1 + [(W_c + W_m) \times L_2 \times f_1 \times f_p + L_{2S} \times W_m \times f_2 \times S] \} \times T(\alpha_2)$$

$$AD \quad F_3 = F_2 + [(W_c + W_m) \times L_3 \times f_1 \times f_p + L_{3S} \times W_m \times f_2 \times S] \times 9,81$$

$$AE \quad F_4 = \{ F_3 + [(W_c + W_m) \times L_4 \times f_1 \times f_p + L_{4S} \times W_m \times f_2 \times S] \} \times T(\alpha_4)$$

$$AF \quad F_5 = F_4 + [(W_c + W_m) \times L_5 \times f_1 \times f_p + L_{5S} \times W_m \times f_2 \times S] \times 9,81$$

**PASLANMAZ BANT SEÇİMİ/CHOICE OF STAINLESS STEEL CHAIN****Güç/Power**

Tahrik dişlisi için gerekli olan güç formülü/The driven sprocket is required the following power:

$$P = \frac{F_t \times v}{6 \times 10^4}$$

P= Güç/Power (kW), F_t =Tahrik dişlisindeki kuvvet/Chain tension at headshaft on the chain (N),
v= Hız/Speed (m/min)

ÖRNEK/EXAMPLE

815 model bant kullanılmış olup taşıma hattında şişe taşınacaktır. Şişelerin her birinin ağırlığı 1,5 kg olup aralarında 20'şer cm (metre başına 5 şişe) boşluk bulunmaktadır. Taşıma hattı saatte 10 kez durup tekrar çalışmaktadır. Konveyördeki ürünlerin birikme mesafesi 8 m.'dir.

The 815 chain, dry-operating, conveys glass bottles. Each bottle weights 1,5 Kg and they are placed on the chain at 20 cm intervals (5 bottles per metre). The stops and restarts 10 times per hour. There is accumulation of the 20% operating time and on a length of 8 metres.

Amaçlar/Aims:

Bant kontrolü/Chain checking:

Tahrik mil için gerekli olan güç/Calculation of the power needed by the shaft.

Çalışma bilgileri/Start up data:

L : Konveyör uzunluğu/Conveyor length = 12 m

W_c : Bant ağırlığı/Chain weight = 2,6 kg/m

W_m : Taşınacak malzeme ağırlığı/Conveyed product weight = 7,5 kg/m

f_1 : Sürtünme faktörü/Friction factor = 0,20

Tablo/Table A: Bant-polietilen yataklama/chain-polyethylene wear strip)

v : Hız/Speed = 45 m/dk (m/min)

f_p : Çalıştırma faktörü/Start up factor = 1,7

S Kayma oranı/Slippage factor= 0,7 (tablo/table C)

L_s : Birikim mesafesi/Length with accumulation = 8m

F_2 : Sürtünme faktörü/Friction factor =0,45 (tablo/table A: bant-cam şişe/chain-glass bottle)

: Kayma zamanı oranı/Slippage time percentage = %20

Tahrik milindeki hesaplanan bant kuvveti/Calculation of the chain tension at headshaft (F_t)

$$F_t = [(2W_c + W_m) \times L \times f_1 \times f_p + L_s \times W_m \times f_2 \times S] \times 9,81$$
$$= [(2 \times 2,6 + 7,5) \times 12 \times 0,20 \times 1,7 + 8 \times 7,5 \times 0,45 \times 0,70] \times 9,81$$
$$= 693,72 \text{ N}$$

Hesaplanan hız ve uzunluk oranı/Calculation of the speed/Length ratio (v/L)

$$v/L = 45/12$$

$$= 3,75 \text{ (m/dk/m) dk:min}$$

Müsade edilen çalışma yüklemesi grafiğinin gösterdiği gibi mal seçimi uygun olup hız oranı 1300 Newton'dur. The allowable working load diagram shows that the maximum chain tension at headshaft available for that chain and for that speed ratio is 1300 N.

Hesaplanan güç/Calculation of power (P)

$$P = \frac{F_t \times v}{6 \times 10^4} = \frac{693,72 \times 45}{6 \times 10^4} = 0,520 \text{ kW}$$



PASLANMAZ BANT SEÇİMİ/CHOICE OF STAINLESS STEEL CHAIN

Yapılan değerlendirmeler sonucunda tahrik milindeki bant kuvveti ile bu bantın hız/uzunluk oranı bulunduğundan sonra bu oran aşağıda bulunan grafikteki 4 bant kuvveti ile eğride kesiştirilerek bu kesişim noktasını karşılık gelen bant modeli seçilir.

Having evaluated the chain tension at headshaft which the chain is subject to, and calculated the speed/length of the conveyor ratio, the two values are stated in 4. The chain suitable for the one whose curve is immediately above the intersection of the two values.

4

Doğrusal bantlar için müsaade edilen yüklem değerlerini gösteren grafik
Straight running chains allowable working load diagram

F_t = Tahrik milindeki bant kuvveti/Chain tension at headshafts (N)

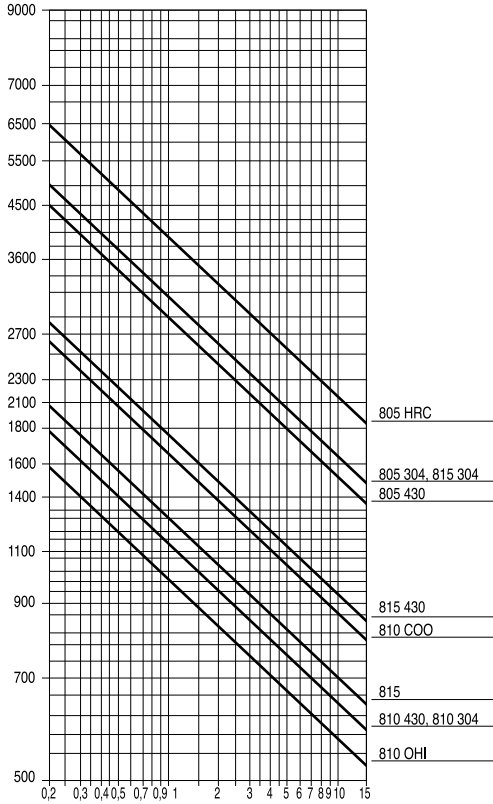

O: Hız-Uzunluk oranı = $\frac{\text{Hız/Speed (m/1')}}{\text{Uzunluk/Length (m)}}$

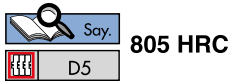

805 HRC

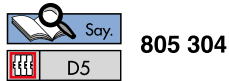

805 304

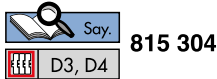

815 304

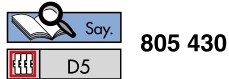

805 430

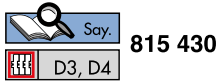

815 430

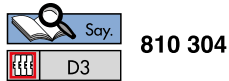

810 304

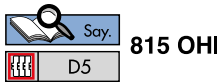

815 OHI

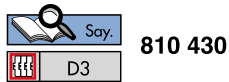

810 430

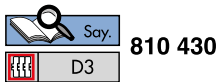

810 430

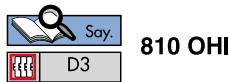

810 OHI

Dönüşlü bantlar için müsaade edilen yüklem değerlerini gösteren grafik
Sideflexing chains allowable working load diagram

F_t = Tahrik milindeki bant kuvveti/Chain tension at headshafts (N)

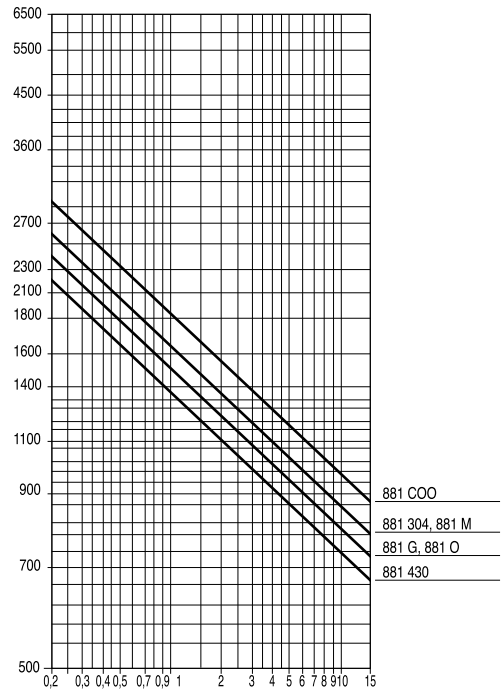

O: Hız-Uzunluk oranı = $\frac{\text{Hız/Speed (m/1')}}{\text{Uzunluk/Length (m)}}$

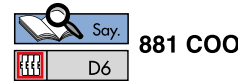

881 COO

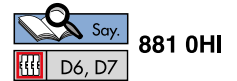

881 OHI



881 M

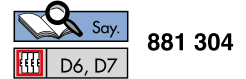

881 304



820 DÜZGÜN DOĞRUSAL BAKLA BANT/STRAIGHT PLATE CHAINS

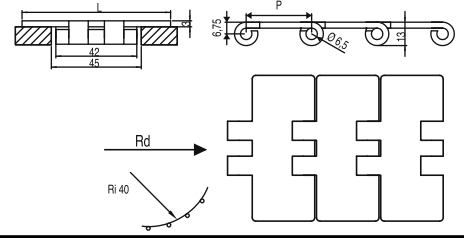
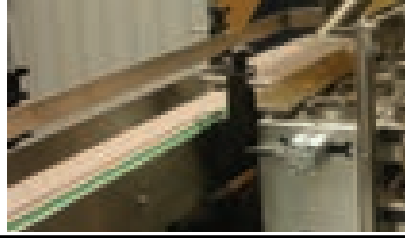
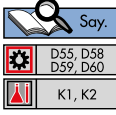

mm											
RM	P	L	M	PIN	Kg/m	Stok Kod Stock Code	PIN	Kg/m	Stok Kod Stock Code	Metre/Meter (m)	Feet (ft)
-	36,4	82,6		Paslanmaz Çelik Stainless Steel AISI 304	0,83	820 B00 082	PP6.6	0,64	820 BPA 082	3,048	10
		101,6			0,95	820 B00 101		0,75	820 BPA 101		
		114,3			1,03	820 B00 114		0,85	820 BPA 114		
		152,4			1,25	820 B00 152		0,95	820 BPA 152		
		190,5			1,47	820 B00 190		1,05	820 BPA 190		
		Beyaz Asetal White Acetal			Plastik Plastic						

mm											
RM	P	L	M	PIN	Kg/m	Stok Kod Stock Code	PIN	Kg/m	Stok Kod Stock Code	Metre/Meter (m)	Feet (ft)
-	36,4	82,6		Paslanmaz Çelik Stainless Steel AISI 304	0,83	820 G00 082	PP6.6	0,64	820 GPA 082	3,048	10
		88,9			0,87	820 G00 088		0,64	820 GPA 088		
		101,6			0,95	820 G00 101		0,75	820 GPA 101		
		114,3			1,03	820 G00 114		0,85	820 GPA 114		
		152,4			1,25	820 G00 152		0,95	820 GPA 152		
		190,5			1,47	820 G00 190		1,05	820 GPA 190		
Gri Asetal Grey Acetal (D)	Plastik Plastic										



mm											
RM	P	L	M	PIN	Kg/m	Stok Kod Stock Code	PIN	Kg/m	Stok Kod Stock Code	Metre/Meter (m)	Feet (ft)
-	36,4	82,6		Paslanmaz Çelik Stainless Steel AISI 304	0,83	820 K00 082	PP6.6	0,64	820 KPA 082	3,048	10
		88,9			0,87	820 K00 088		0,64	820 KPA 088		
		101,6			0,95	820 K00 101		0,75	820 KPA 101		
		114,3			1,03	820 K00 114		0,85	820 KPA 114		
		152,4			1,25	820 K00 152		0,95	820 KPA 152		
		190,5			1,47	820 K00 190		1,05	820 KPA 190		
Kahverengi Asetal Brown Acetal (LF)	Plastik Plastic										

mm											
RM	P	L	M	PIN	Kg/m	Stok Kod Stock Code	PIN	Kg/m	Stok Kod Stock Code	Metre/Meter (m)	Feet (ft)
-	36,4	82,6		Paslanmaz Çelik Stainless Steel AISI 304	0,83	820 S00 082	PP6.6	0,64	820 SPA 082	3,048	10
		88,9			0,87	820 S00 088		0,64	820 SPA 088		
		101,6			0,95	820 S00 101		0,75	820 SPA 101		
		114,3			1,03	820 S00 114		0,85	820 SPA 114		
		152,4			1,25	820 S00 152		0,95	820 SPA 152		
		190,5			1,47	820 S00 190		1,05	820 SPA 190		
Siyah Asetal Black Acetal Antistatik Antistatic	Plastik Plastic										

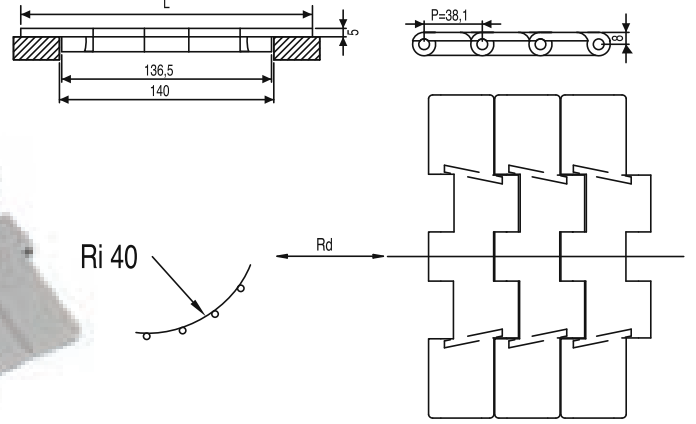

mm											
RM	P	L	M	PIN	Kg/m	Stok Kod Stock Code	PIN	Kg/m	Stok Kod Stock Code	Metre/Meter (m)	Feet (ft)
-	36,4	82,6		Paslanmaz Çelik Stainless Steel AISI 316	0,83	820 YPP 082	PP6.6	0,64	820 YPP 082	3,048	10
		88,9			0,87	820 YPP 088		0,64	820 YPP 088		
		114,3			1,03	820 YPP 114		0,75	820 YPP 114		
		82,6			1,10	820 316 082		0,85	820 316 082		
		88,9			1,14	820 316 088		0,95	820 316 088		
		114,3			1,30	820 316 114		1,05	820 316 114		
Yeşil Polipropilen Green Polypropylene	Plastik/Plastic										

*Özel üretim yapılır./On request special production is available.



821 DÜZGÜN DOĞRUSAL AĞIR TİP ÇİFT MENTEŞELİ ASETAL BAKLA BANT (BOO-T)/DOUBLE HINGES CHAINS

mm								
RM	P	L		PIN	Kg/m	Stok Kod Stock Code	Metre/Meter (m)	Feet (ft)
-	38,1	190,5		Paslanmaz Çelik Stainless Steel AISI 304	2,5	821 B00 190	3,048	10
		254,0			2,95	821 B00 254		
		304,8			3,25	821 B00 304		



821 DÜZGÜN DOĞRUSAL AĞIR TİP ÇİFT MENTEŞELİ ASETAL BAKLA BANT (GOO-T)/DOUBLE HINGES CHAINS

mm								
RM	P	L		PIN	Kg/m	Stok Kod Stock Code	Metre/Meter (m)	Feet (ft)
-	38,1	190,5		Paslanmaz Çelik Stainless Steel AISI 304	2,5	821 G00 190	3,048	10
		254,0			2,95	821 G00 254		
		304,8			3,25	821 G00 304		

821 DÜZGÜN DOĞRUSAL AĞIR TİP ÇİFT MENTEŞELİ ASETAL BAKLA BANT (KOO-T)/DOUBLE HINGES CHAINS

mm								
RM	P	L		PIN	Kg/m	Stok Kod Stock Code	Metre/Meter (m)	Feet (ft)
-	38,1	190,5		Paslanmaz Çelik Stainless Steel AISI 304	2,5	821 K00 190	3,048	10
		254,0			2,95	821 K00 254		
		304,8			3,25	821 K00 304		

821 DÜZGÜN DOĞRUSAL AĞIR TİP ÇİFT MENTEŞELİ ASETAL BAKLA BANT (SOO-T)/DOUBLE HINGES CHAINS

mm								
RM	P	L		PIN	Kg/m	Stok Kod Stock Code	Metre/Meter (m)	Feet (ft)
-	38,1	190,5		Paslanmaz Çelik Stainless Steel AISI 304	2,5	821 S00 190	3,048	10
		254,0			2,95	821 S00 254		
		304,8			3,25	821 S00 304		

*Özel üretim yapılır./On request special production is available.

821 BPM BONCUK MAKARALI DÜZGÜN DOĞRUSAL BANTLAR/STRAIGHT ROLLER CHAINS

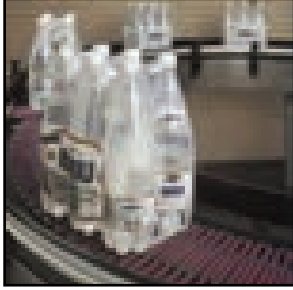
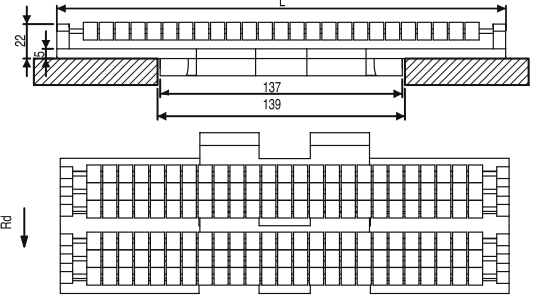
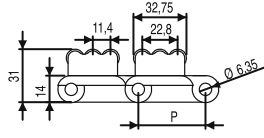

mm							
L	P		PIN	Kg/m	Stok Kod Stock Code	Metre/Meter (m)	Feet (ft)
190,5	38,1	Poliasetal Polyacetal	Paslanmaz Çelik Stainless Steel (AISI 304)	2,71	821 BPM 190	3,048	10
254,0				3,06	821 BPM 254		
304,8				3,39	821 BPM 304		

882 TAB BPM BONCUK MAKARALI DÖNÜŞLÜ BANTLAR/CURVE ROLLER CHAINS

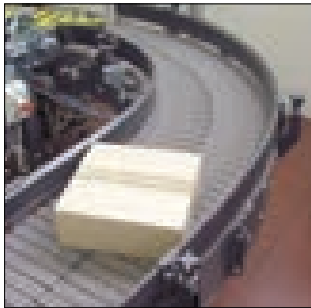
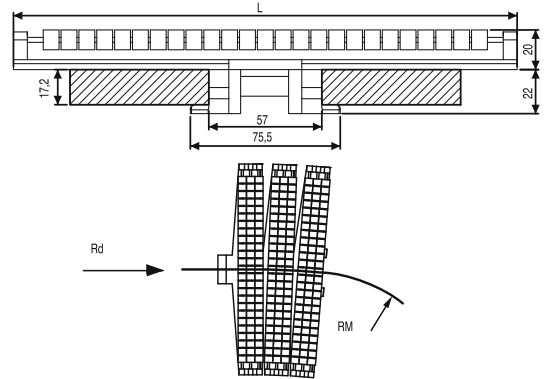
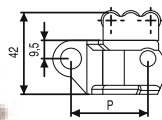

mm.							
L	P		PIN	Kg/m	Stok Kod Stock Code	Metre/Meter (m)	Feet (ft)
114,3	38,1	Poliasetal Polyacetal	Paslanmaz Çelik Stainless Steel (AISI 304)	2,44	882 BPT 114	3,048	10
190,5				2,51	882 BPT 190		
254,0				2,97	882 BPT 254		
304,8				3,53	882 BPT 304		

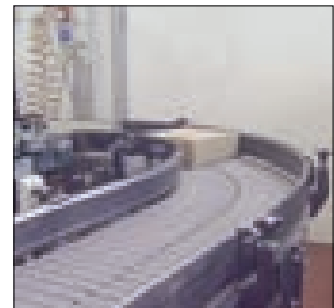
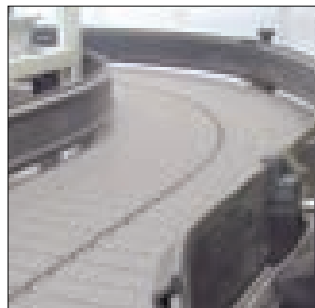

*Özel üretim yapılır./On request special production is available.

880M TIRNAKSIZ MANYETİK DÖNÜŞLÜ BANT/MAGNETIC SIDEFLEXING CHAIN FOR CURVED CONVEYORS

Say.	
D61, D63 D64	
K1, K2	

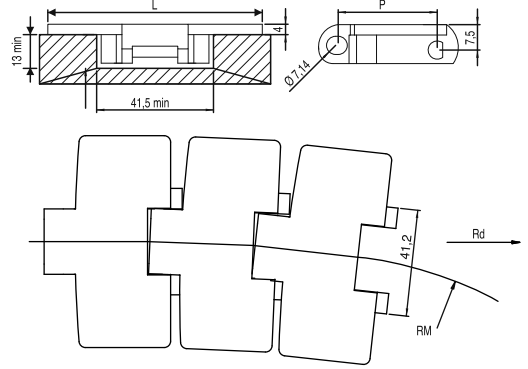
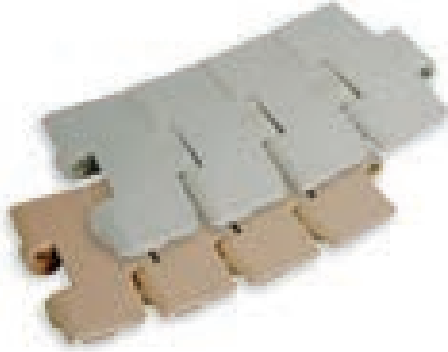

P	L	RM	M	PIN	Kg/m	Stok Kod Stock Code	Metre/Meter (m)	
38,1	82,6	457	Gri Asetal (D) Grey Acetal	Paslanmaz Çelik Stainless Steel AISI 430	1,04	880 TGT 082	3.048	10
	114,3	550			1,21	880 TGT 114		
	82,6	457	Siyah Asetal Black Acetal		1,04	880 TST 082		
	114,3	550			1,21	880 TST 114		
	82,6	457	Kahverengi Asetal Brown Acetal (LF)		1,04	880 TKT 082		
	114,3	550			1,21	880 TKT 114		
	82,6	457	Beyaz Asetal White Acetal		1,04	880 TBT 082		
	114,3	550			1,21	880 TBT 114		

880 TAB-KULAKLI DÖNÜŞLÜ BANT (TGO-T)/PLATE CURVED FOR CURVED CONVEYORS

Say.	
D61, D63 D64	
K1, K2	

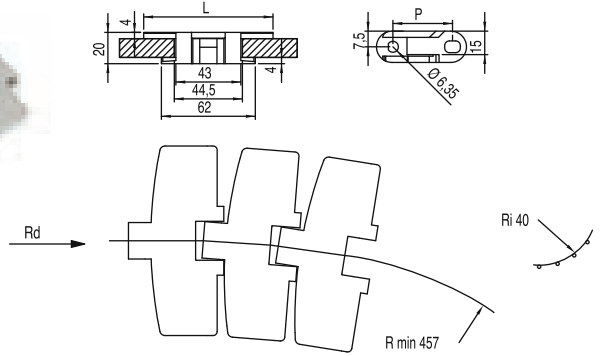
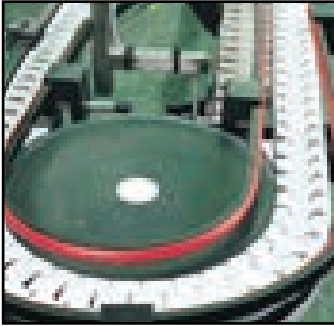

P	L	RM	M	PIN	Kg/m	Stok Kod Stock Code	PIN	Kg/m	Stok Kod Stock Code	Metre/Meter (m)	
38,1	82,6	457	Gri Asetal (D) Grey Acetal	Paslanmaz Çelik Stainless Steel AISI 304	1,04	880 TBG 082	Plastik Plastic		880 TPG 082	3.048	10
	114,3	550			1,21	880 TBG 114			880 TPG 114		
	82,6	457	Siyah Asetal Black Acetal		1,04	880 TBS 082			880 TPS 082		
	114,3	550			1,21	880 TBS 114			880 TPS 114		
	82,6	457	Kahverengi Asetal Brown Acetal (LF)		1,04	880 TBK 082			880 TPK 082		
	114,3	550			1,21	880 TBK 114			880 TPK 114		
	82,6	457	Beyaz Asetal White Acetal		1,04	880 TBB 082			880 TPB 082		
	114,3	550			1,21	880 TBB 114			880 TPB 114		

*Özel üretim yapılır./On request special production is available.





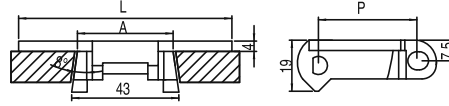
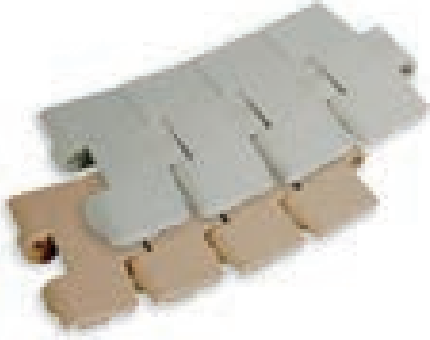

880 TIRNAKLI DÖNÜŞLÜ BANT/SIDEFLEXING CHAIN FOR CURVED CONVEYORS

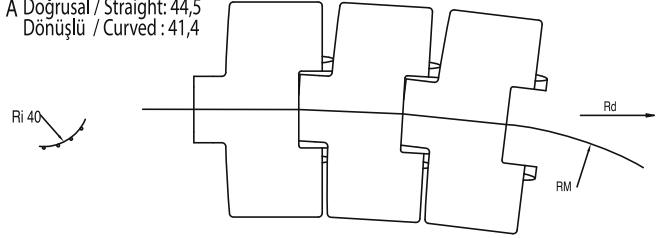
 Sayı.
 D61, D63 D64
 K1, K2



A Doğrusal / Straight: 44,5
Dönüşlü / Curved: 41,4



mm									
P	L	RM		PIN	Kg/m	Stok Kod Stock Code	Metre/Meter (m)	Feet (ft)	
38,1	82,6	457	Gri Asetal (D) Grey Acetal		Paslanmaz Çelik Stainless Steel AISI 304	1,04 880 TGO 082	3.048	10	
	114,3	550				1,21 880 TGO 114			
	82,6	457	Siyah Asetal Black Acetal		Paslanmaz Çelik Stainless Steel AISI 304	1,04 880 TSO 082			
	114,3	550				1,21 880 TSO 114			
	82,6	457	Kahverengi Asetal Brown Acetal (LF)		Paslanmaz Çelik Stainless Steel AISI 304	1,04 880 TKO 082			
	114,3	550				1,21 880 TKO 114			
	82,6	457	Beyaz Asetal White Acetal		Paslanmaz Çelik Stainless Steel AISI 304	1,04 880 TBO 082			
	114,3	550				1,21 880 TBO 114			

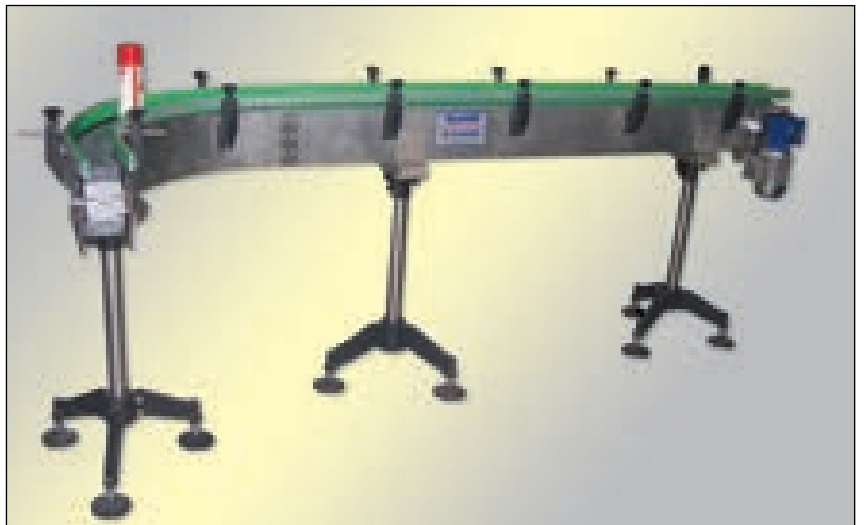
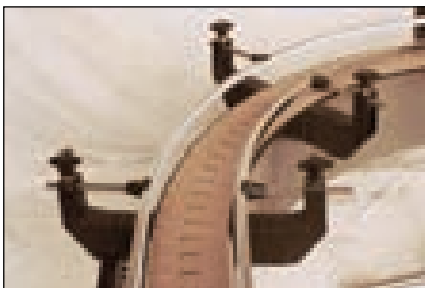
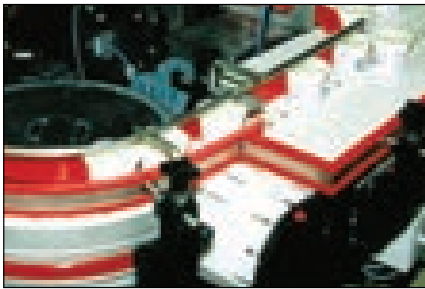
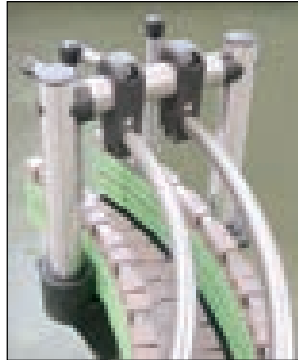
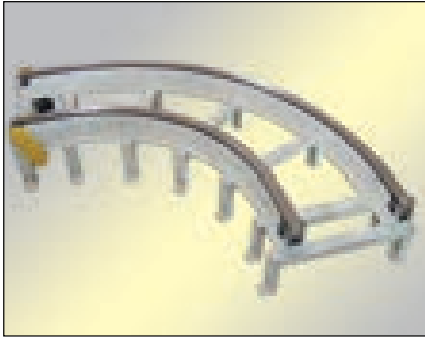

*Özel üretim yapılır./On request special production is available.

871 DÜZGÜN DOĞRUSAL ASETAL BAKLA BANT/PLATE CHAINS

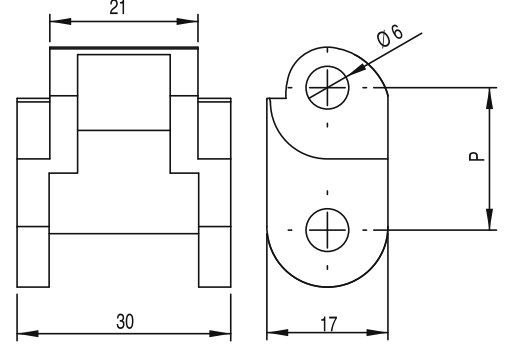

mm								
P	M	PIN	Kg/m	Stok Kod Stock Code	Metre/Meter (m)	Feet (ft)		
20	POM Beyaz Asetal White Acetal	Paslanmaz Çelik Stainless Steel AISI 304	0,65	871 B00 030	3,048	10		
20	POM Kahverengi Asetal Brown Acetal		0,65	871 K00 030				
20	POM Siyah Asetal Black Acetal		0,65	871 S00 030				

882 TAB KULAKLI DÖNÜŞLÜ BANT/PLATE CHAINS FOR CURVED CONVEYORS

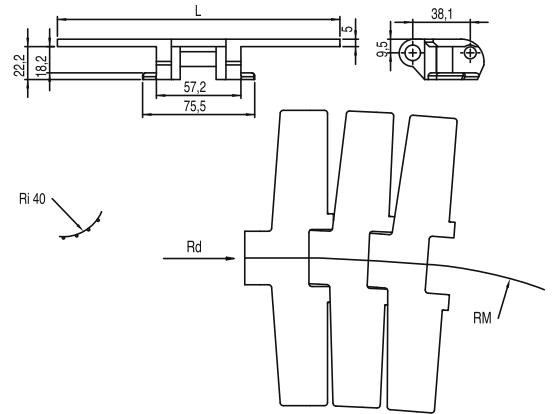
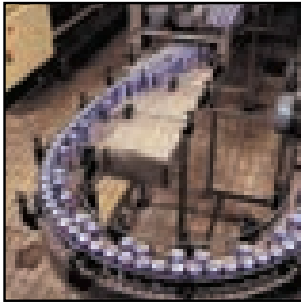

mm									
RM	L	P	M	PIN	Kg/m	Stok Kod Stock Code	Metre/Meter (m)	Feet (ft)	
610	190,5	38,1	Asetal Acetal	Paslanmaz Çelik Stainless Steel AISI 304	2,43	882 TBK 190	3,048	10	
610	254					Gri/Grey (D)			882 TBG 190
610	304,8								882 TBK 254
					2,87	882 TBG 254			
					3,41	882 TBK 304			
						882 TBG 304			

*Özel üretim yapılır./On request special production is available.

843 ASETAL ZİNCİR BANT/PLATE TOP CHAINS WITH BASE ROLLER CHAINS

K1, K2

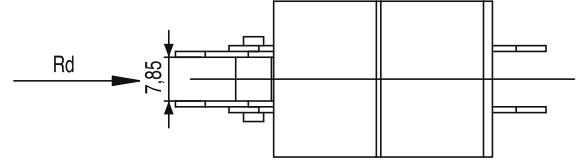
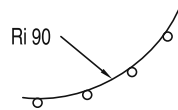
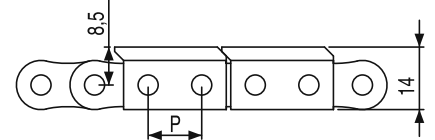
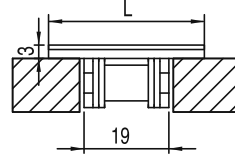

mm							
P (mm)	L	RM	M	Kg/m	Stok Kod Stock Code	Metre/Meter (m)	Feet (ft)
12,7 (1/2")	34,9	-	Gri Asetal Grey Acetal	0,90	843 G00 034	3,048	10
	50,8		(D)	0,98	843 G00 050		
	82,6		(D)	1,10	843 G00 082		
	34,9	-	Kahverengi Asetal Brown Acetal	0,90	843 K00 034		
	50,8		(LF)	0,98	843 K00 050		
	82,6		(LF)	1,10	843 K00 082		
	34,9	-	Beyaz Asetal White Acetal	0,90	843 B00 034		
	50,8			0,98	843 B00 050		
	82,6			1,10	843 B00 082		
	34,9	-	Siyah Asetal Black Acetal	0,90	843 S00 034		
	50,8			0,98	843 S00 050		
	82,6			1,10	843 S00 082		

854 KULAKLI KASA TAŞIMA BANTI/CRATE CONVEYOR CHAINS

Say.

*

K1, K2

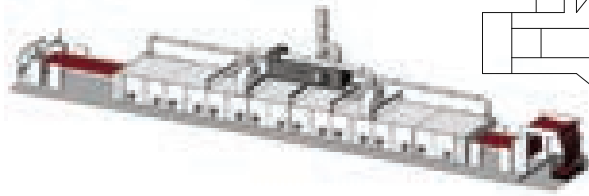
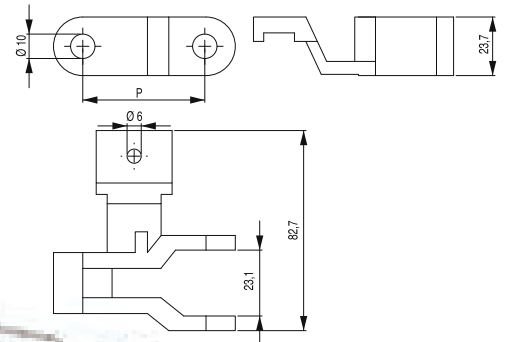
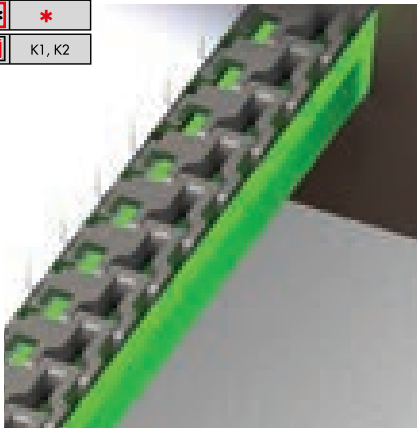

mm							
P	RM	M	PIN	Kg/m	Stok Kod Stock Code	Metre/Meter (m)	Feet (ft)
49,5	-	Güçlendirilmiş Polyamid Siyah Reinforced Polyamide Black		0,041	854 SOO PA6	3.048	10
			Paslanmaz Çelik Stainless Steel AISI 304		854 GOO MOS		

*Özel üretim yapılır./On request special production is available.

863 ASETAL ZİNCİR BANT/PLATE TOP CHAINS WITH BASE ROLLER CHAINS

K1, K2

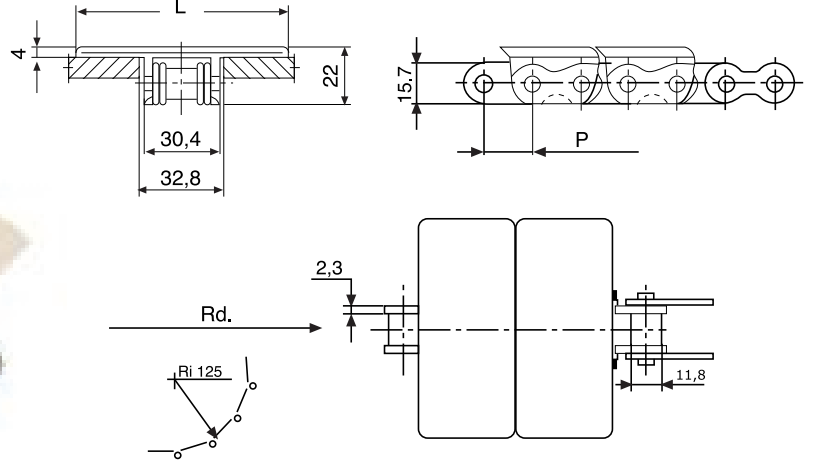
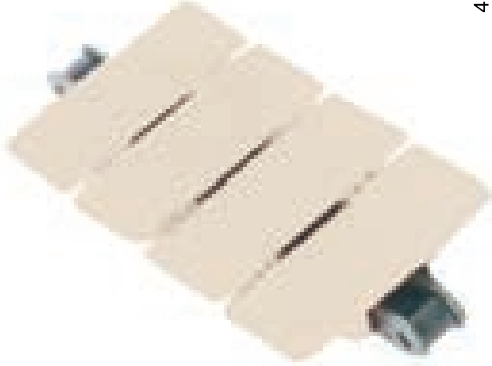

mm									
P	L	RM	M	Zincir/Roller Chain	Kg/m	Stok Kod Stock Code	Metre/Meter (m)	Feet (ft)	
19,05 (3/4")	114,3	-	Gri Asetal Grey Acetal (D)	Paslanmaz Çelik Stainless Steel AISI 304	2,23	863 G00 114	3,048	10	
	152,4				2,53	863 G00 152			
	190,5				2,68	863 G00 190			
	114,3	-	Kahverengi Asetal Brown Acetal (LF)		2,23	863 K00 114			
	152,4				2,53	863 K00 152			
	190,5				2,68	863 K00 190			
	114,3	-	Beyaz Asetal White Acetal		2,23	863 B00 114			
	152,4				2,53	863 B00 152			
	190,5				2,68	863 B00 190			
	114,3	-	Siyah Asetal Black Acetal		2,23	863 S00 114			
	152,4				2,53	863 S00 152			
	190,5				2,68	863 S00 190			



*Özel üretim yapılır./On request special production is available.

1843 ASETAL ZİNCİR BANT/PLATE TOP CHAINS WITH BASE ROLLER CHAINS

K1, K2

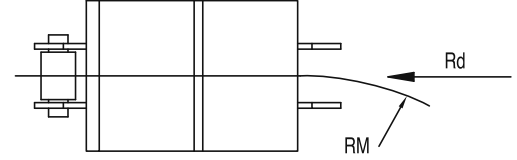
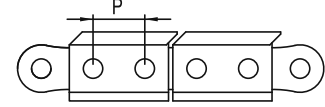
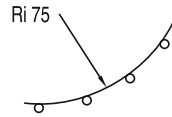
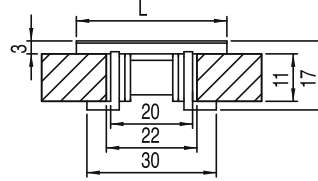

mm								
P	L	RM	(M)	Zincir/Roller Chain	Kg/m	Stok Kod Stock Code	Metre/Meter (m)	Feet (ft)
12,7	31,8	350	Gri Asetal Grey Acetal (D)	Paslanmaz Çelik Stainless Steel AISI 304	0,90	184 3G0 031	3,048	10
	82,6				1,10	184 3G0 082		
	31,8		Kahverengi Asetal Brown Acetal (LF)		0,90	184 3K0 031		
	82,6				1,10	184 3K0 082		

1873 ASETAL ZİNCİR BANT/PLATE TOP CHAINS WITH BASE ROLLER CHAINS

K1, K2

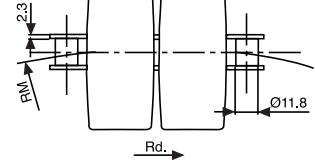
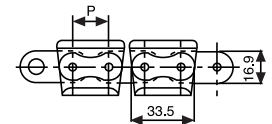
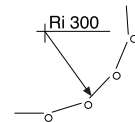
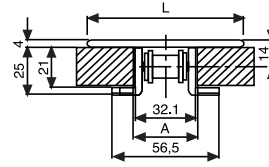

mm								
P	L	RM	(M)	Zincir/Roller Chain	Kg/m	Stok Kod Stock Code	Metre/Meter (m)	Feet (ft)
19,05	57,2	356	Gri Asetal Grey Acetal (D)	Paslanmaz Çelik Stainless Steel AISI 304	2,00	187 3G0 057	3,048	10
	82,6	356			2,10	187 3G0 082		
	114,3	356			2,30	187 3G0 114		
	152,4	457			2,40	187 3G0 152		
	190,5	457			2,60	187 3G0 190		
	254,0	457			2,80	187 3G0 254		
	304,8	610			3,00	187 3G0 304		
19,05	57,2	356	Kahverengi Asetal Brown Acetal (LF)		2,00	187 3K0 057		
	82,6	356			2,10	187 3K0 082		
	114,3	356			2,30	187 3K0 114		
	152,4	457			2,40	187 3K0 152		
	190,5	457			2,60	187 3K0 190		
	254,0	457			2,80	187 3K0 254		
	304,8	610			3,00	187 3K0 304		

*Özel üretim yapılır./On request special production is available.

BONCUK MAKARALI BANT/SIDEFLEXING CHAIN FOR CURVED CONVEYORS

Say.	
E30	
K1, K2	

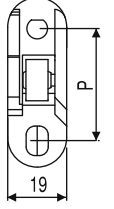
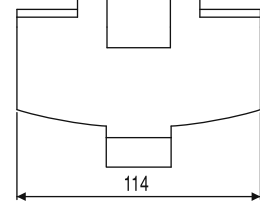
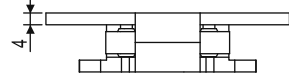
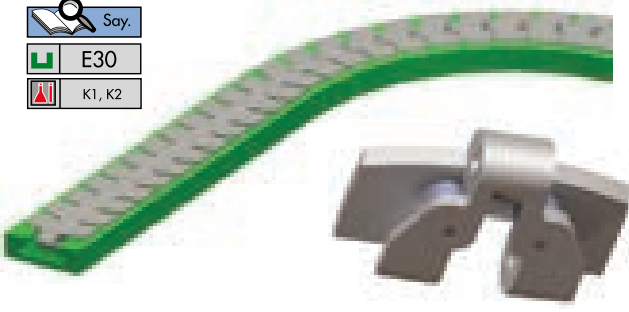

P	RM	M	Genişlik Width	PIN	Kg/m ²	Stok Kod Stock Code	
38,1	650	POM	114	SS	1,50	885 SKM 114	3.048

YARASA BANT (DÜZ KULAKLI)/PLAIN CHAINS

Say.	
E30	
K1, K2	
D57	

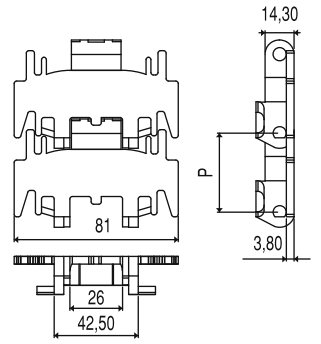

P	RM	M	Genişlik Width	PIN	Kg/m	Stok Kod Stock Code	
38,1	250	POM	81	PA	0,69	880 TBP 082	3.048
				SS	0,89	880 TBO 082	

YARASA BANT (SİLİNDİR KULAKLI)/PLAIN CHAINS

Say.	
E30	
K1, K2	
D57	

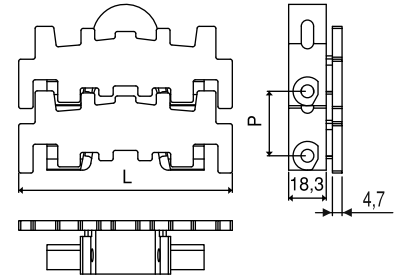

P	RM	M	L	PIN	Kg/m	Stok Kod Stock Code	
34	300	POM	82	SS	0,995	881 KBO 082	3.048
	650		104		1,250	881 KBO 104	

*Özel üretim yapılır./On request special production is available.

863 3 TIRNAKLI KAUÇUK BANT/RUBBER CHAINS

K1, K2

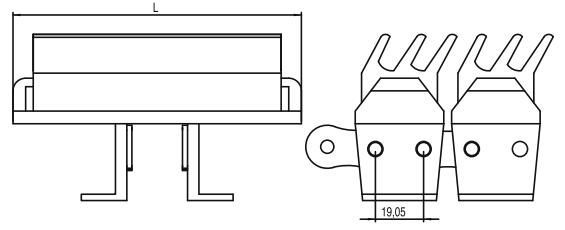

Diğer ölçüler talep üzerine karşılır
Another different dimensions made of request

mm										
RM	PIN	P	L			Kg/m	Stok Kod Stock Code	Metre/Meter (m)	Feet (ft)	
381	-	3/4" (19.05)	114,3	POM	(GRİ/GREY) (SİYAH/BLACK)	KAUÇUK RUBBER	0,126	863 GKO 114 863 SKO 114	3,048	10

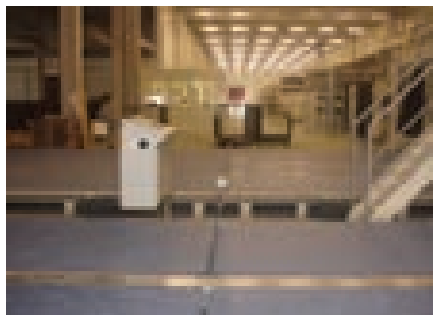
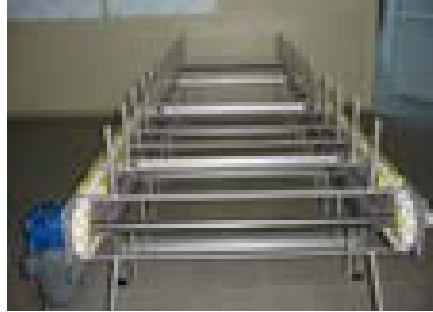

*Özel üretim yapılır./On request special production is available.

857 KASA TAŞIMA BANTI/CRATE CHAINS

Say.	
D22	
K1, K2	
E29	



Yeni
New

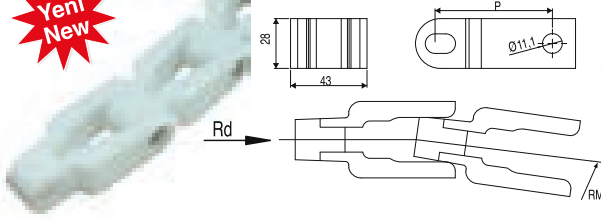

mm		(POM: Poliasetal/Polyacetal)					
RM	PIN	P	M	Kg/m	Stok Kod Stock Code	Metre/Meter (m)	Feet (ft)
650	Paslanmaz Çelik Stainless Steel AISI 304	63,5	POM Beyaz/White	1,530	857 B00 POM	3,048	10
		63,5	POM Siyah/Black	1,530	857 S00 POM		

858 KULAKLI KASA TAŞIMA BANTI/CRATE CHAINS

Say.	
D22	
K1, K2	
E29	



Yeni
New

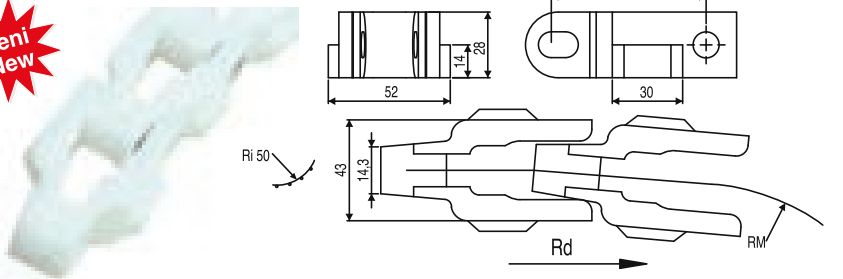

mm		(PA6 : Polyamid/Polyamide POM: Poliasetal/Polyacetal)					
RM	PIN	P	M	Kg/m	Stok Kod Stock Code	Metre/Meter (m)	Feet (ft)
650	Paslanmaz Çelik Stainless Steel AISI 304	63,5	POM Beyaz/White	1,560	858 B00 POM	3,048	10
		63,5	POM Siyah/Black	1,560	858 S00 POM		

857-858 KASA TAŞIMA BANTI DİŞLİSİ/SPROCKET FOR 857-858 CRATE CHAINS

Say.	
D22	
K1, K2	

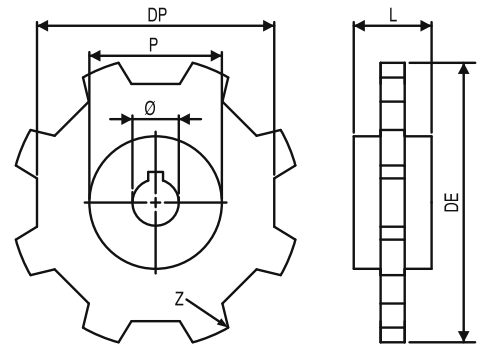

mm													(PA6 : Polyamid/Polyamide)	
Tahrik Drive	DE	DP	P	Ø	Stok Kod Stock Code		L	Avara Idler	DE	DP	P	Ø	Stok Kod Stock Code	
Z8	170	140	100	25-30	380 D.. K08	10	42	Z8	170	140	100	20-25-30	380 D.. T08	
Z10	207	177	100	25-30	380 D.. K10	10	42	Z10	207	177	100	20-25-30	380 D.. T10	
Z12	250	218	100	25-30	380 D.. K12	10	42	Z12	250	218	100	20-25-30	380 D.. T12	

*Özel üretim yapılır./On request special production is available.

860 - KULAKLI (KARDENİK) OMURGALI BANT/CARDANIC CHAINS

Say.	
D68, D70	
K1, K2	

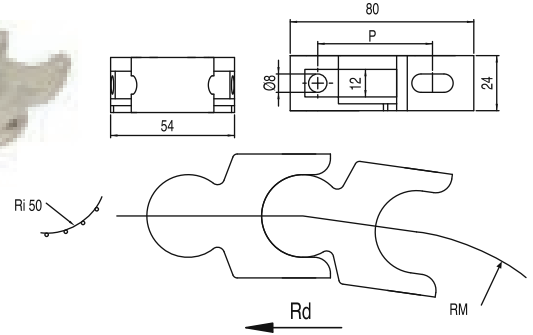

mm								
P	RM		PIN	Kg/m	Stok Kod Stock Code	Metre/Meter (m)	Feet (ft)	
50	150	Beyaz Poliasetal/White Polyacetal		Paslanmaz Çelik Stainless Steel AISI 304	1,400	860 BOO 058	3.048	10
50	150	Siyah Poliasetal/Black Polyacetal			1,400	860 SOO 058		

865 - KULAKSIZ (KARDENİK) OMURGALI BANT/CARDANIC CHAINS

Say.	
D68, D70	
K1, K2	

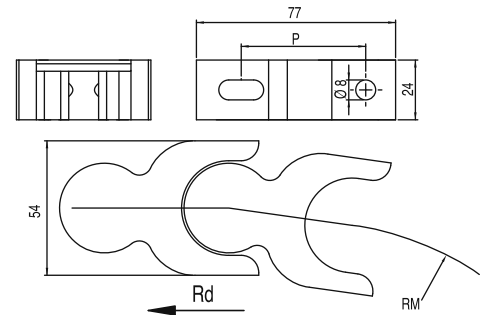

mm								
P	RM		PIN	Kg/m	Stok Kod Stock Code	Metre/Meter (m)	Feet (ft)	
50	150	Beyaz Poliasetal/White Polyacetal		Paslanmaz Çelik Stainless Steel AISI 304	1,380	865 BOO 058	3.048	10
50	150	Siyah Poliasetal/Black Polyacetal			1,380	865 SOO 058		

! (*) P = Hatve/Pitch=50 mm P01=50 mm x 1 = 50 mm = D → Stok kod/Stock code 867 XXX P01*
 (*) P = Hatve/Pitch=50 mm P02=50 mm x 2 = 100 mm = D → Stok kod/Stock code 867 XXX P02*

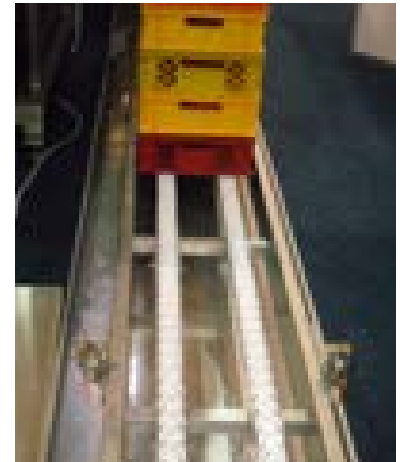
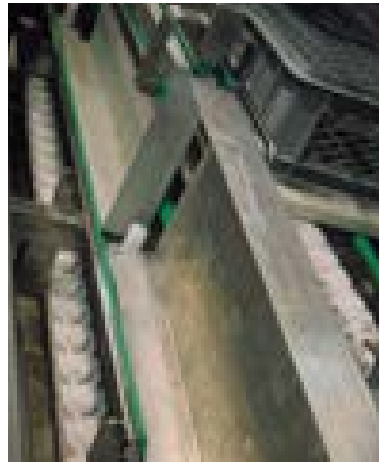
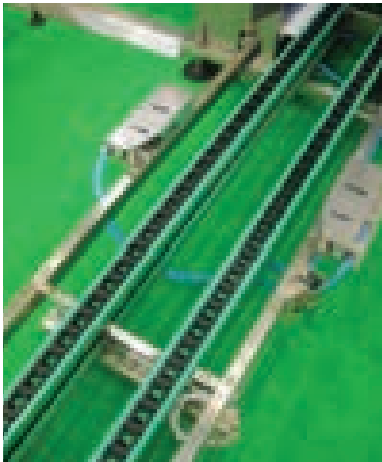

*Özel üretim yapılır./On request special production is available.

870 - KULAKSIZ (KARDENİK) OMURGALI BANT/CARDANIC CHAINS

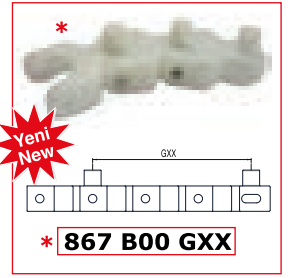
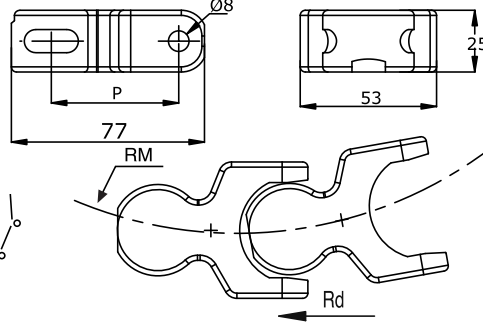
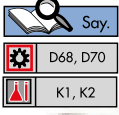

mm							
P	RM	M	PIN	Kg/m	Stok Kod Stock Code	Metre/Meter (m)	Feet (ft)
50	150	Beyaz Poliasetal/White Polyacetal	Paslanmaz Çelik Stainless Steel	1,380	870 B00 058	3.048	10
50	150	Siyah Poliasetal/Black Polyacetal	AISI 304	1,380	870 S00 058		

875 - KULAKSIZ (KARDENİK) OMURGALI BANT/CARDANIC CHAINS

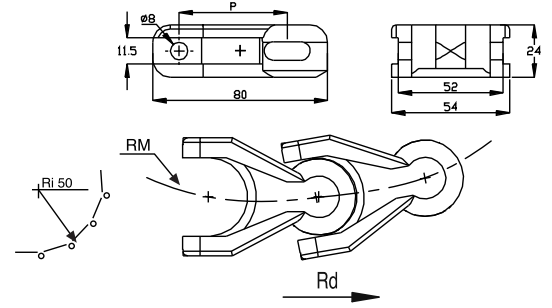
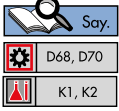

mm							
P	RM	M	PIN	Kg/m	Stok Kod Stock Code	Metre/Meter (m)	Feet (ft)
50	150	Beyaz Poliasetal/White Polyacetal	Paslanmaz Çelik Stainless Steel	1,380	875 B00 058	3.048	10
50	150	Siyah Poliasetal/Black Polyacetal	AISI 304	1,380	875 S00 058		



*Özel üretim yapılır./On request special production is available.

TEKNİK BİLGİ/TECHNICAL INFORMATION

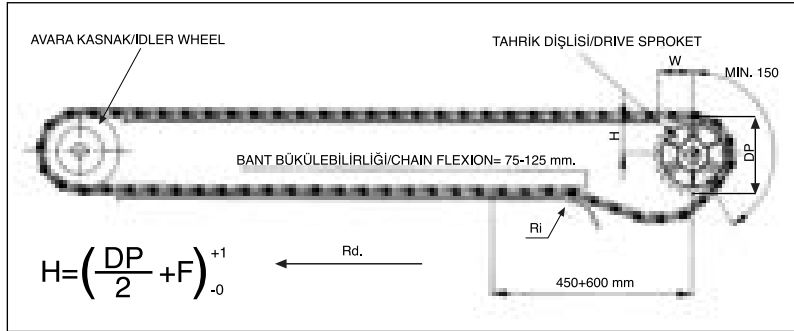

	F	W
400	7,80	35
500	-12,00	50
515	3,90	25
600	-18,50	85
610	-14,00	65
805	3,90	38
810	3,90	38
815	3,90	38
820	3,90	38
821	3,90	38
843	5,95	25
863	10,30	38
880	4,00	38
881	3,90	38
882	5,00	38
1873	9,50	38

TEKNİK BİLGİ/TECHNICAL INFORMATION

Tahrik Dişlisi (tek parça)/Drive Sprocket

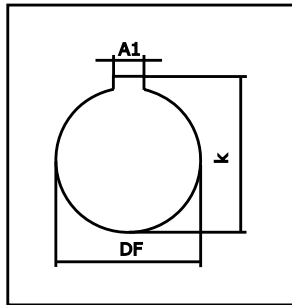

DF	A1	K
25 ^{+0,021} ₋₀	8 ^{+0,036} ₋₀	28,3 ^{+0,02} ₋₀
30 ^{+0,021} ₋₀	8 ^{+0,036} ₋₀	33,3 ^{+0,02} ₋₀
35 ^{+0,025} ₋₀	10 ^{+0,036} ₋₀	38,3 ^{+0,02} ₋₀
40 ^{+0,025} ₋₀	12 ^{+0,043} ₋₀	43,3 ^{+0,02} ₋₀
45 ^{+0,025} ₋₀	14 ^{+0,043} ₋₀	48,3 ^{+0,02} ₋₀
50 ^{+0,028} ₋₀	14 ^{+0,043} ₋₀	53,8 ^{+0,02} ₋₀

Avaya Kasnak/Idler Wheel

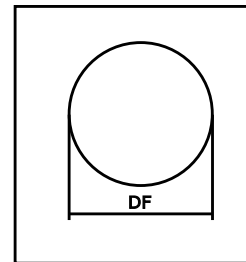

DF
25 ^{+0,2} _{+0,4}
30 ^{+0,2} _{+0,4}
35 ^{+0,2} _{+0,4}
40 ^{+0,2} _{+0,4}
45 ^{+0,2} _{+0,4}
50 ^{+0,2} _{+0,4}

Tahrik Dişlisi (iki parça)/Split Sprocket

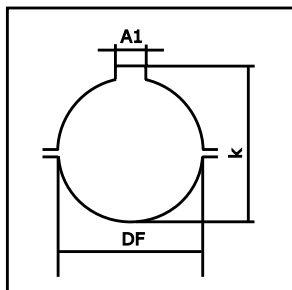

DF	A1	K
25 ^{-0,022} _{-0,074}	8 ^{+0,036} ₋₀	28,3 ^{+0,02} ₋₀
30 ^{-0,021} _{-0,074}	8 ^{+0,036} ₋₀	33,3 ^{+0,02} ₋₀
35 ^{-0,026} _{-0,088}	10 ^{+0,036} ₋₀	38,3 ^{+0,02} ₋₀
40 ^{-0,026} _{-0,088}	12 ^{+0,043} ₋₀	43,3 ^{+0,02} ₋₀
45 ^{-0,026} _{-0,088}	14 ^{+0,043} ₋₀	48,3 ^{+0,02} ₋₀
50 ^{-0,026} _{-0,088}	14 ^{+0,043} ₋₀	53,8 ^{+0,02} ₋₀

ÇALIŞMA SICAKLIKLARI/WORKING TEMPERATURE (°C)

	EN DÜŞÜK DAYANIM SICAKLIĞI MINIMUM TEMPERATURE	EN YÜKSEK DAYANIM SICAKLIĞI MAXIMUM TEMPERATURE	
		KURU ORTAM SICAKLIĞI DRY ENVIRONMENT	ISLAK ORTAM SICAKLIĞI WET ENVIRONMENT
Asetal LF/Acetal LF	-40	+85	+70
Asetal D/Acetal D	-40	+85	+70
Güçlendirilmiş Polipropilen/Reinforced Polypropylene	+5	+105	+105
Polyamid/Polyamide (PA6)	-5	+80	+90
Güçlendirilmiş Polyamid/Reinforced Polyamide (PA6)	-10	+120	+120
Polietilen 1000/UHMW-PE ALPOLEN® 1000	-40	+80	+70
430 Kalite Paslanmaz Çelik/AISI 430 SSC	-40	+260	+120
304 Kalite Paslanmaz Çelik/AISI 304 SSS	-40	+400	+120
Karbonca Zenginleştirilmiş Çelik/Treated Steel (S)	-40	+180	+120

DAYANIM YÜKÜ/MAX. BREAKING LOADS

	M	Newtons
815	SSS SSC	10200 10400
805	SSS SSC	1900 1900
810	SSS SSC	4500 4500
815	SSS	10400
820	LF	3200
821	LF	6500
880	LF	5200
881	SSS SSC	10000 9500
882	LF	8000
900	D	4000
450	AW	1500
400	AW	6500
550	LF	6500
600	AW	8000
610	AW	8000
1700	AW	6500



Yapılan ARGE'ler sonucunda;

*Antistatik Malzemeler
*Yüksek Sıcaklıklar

*Ultraviyole Dirençli Işınlar gibi koşullar,kullanılan hammaddede sonuçlarını etkileyerek teknik verilerde sapmalara yol açabilir.

Our constantly developing engineering department,in collaboration with the leading raw materials suppliers,offers our clients the possibility of specific solutions to suit their particular application needs.

*Antistatic Material.
*High Temperatures.
*Ultraviolet Ray Resistant.

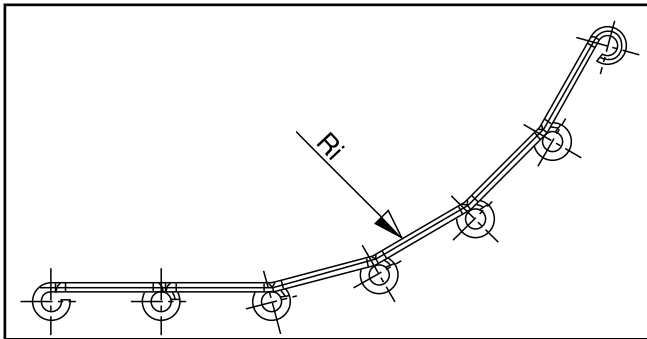
KULLANILABİLİR DÖNÜŞ ARALIKLARI/BACK BEND RADIUS

	Ri
400	300
450	150
515	75
550	50
805	150
810	75
815	150
843	90
863	125
900	0
881	50
882	50
1873	250
1873G	100

945-946 HASIR BANT / 945-946 MODULER CONVEYOR BELTS

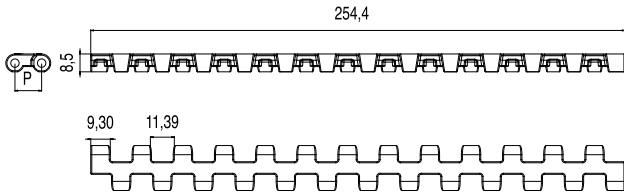
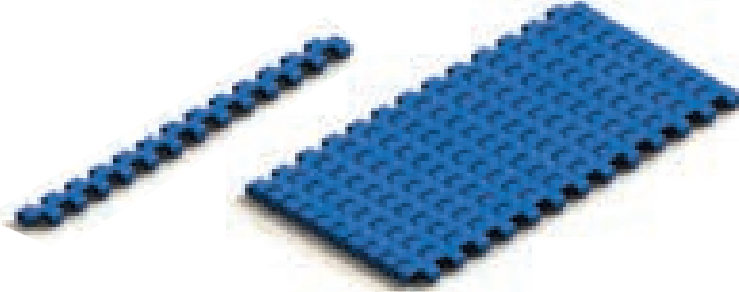

P	RM	M		PIN	Bant Dayanımı Chain Strength (N/m)	Kg/m ²	Stok Kod Stock Code	
12,7	-	PP	254,4	PP	8500	4,5	945 G01 K06	m
				PA	10000	4,5	946 G01 K06	
				PP	12500	6	945 G02 K06	
				PA	15000	6	946 G02 K06	

388 HASIR BANT DİŞLİSİ (12,7 mm)/388 MODULER BELTS DRIVING SPROCKETS

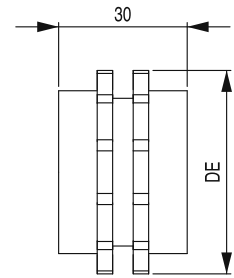
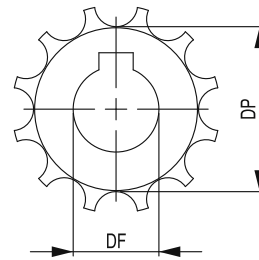

388 DDF T06
388 D15 T06

Z	M	DE	DP	Kg	Stok Kod Stock Code	
6	PA	25,7	18,3	0,035	388 D.. T06	25
8		34	24,4	0,040	388 D.. T08	
25		99	87	0,100	388 D.. T25	15
28		115	103,5	0,132	388 D.. T28	

*Özel üretim yapılır./On request special production is available.

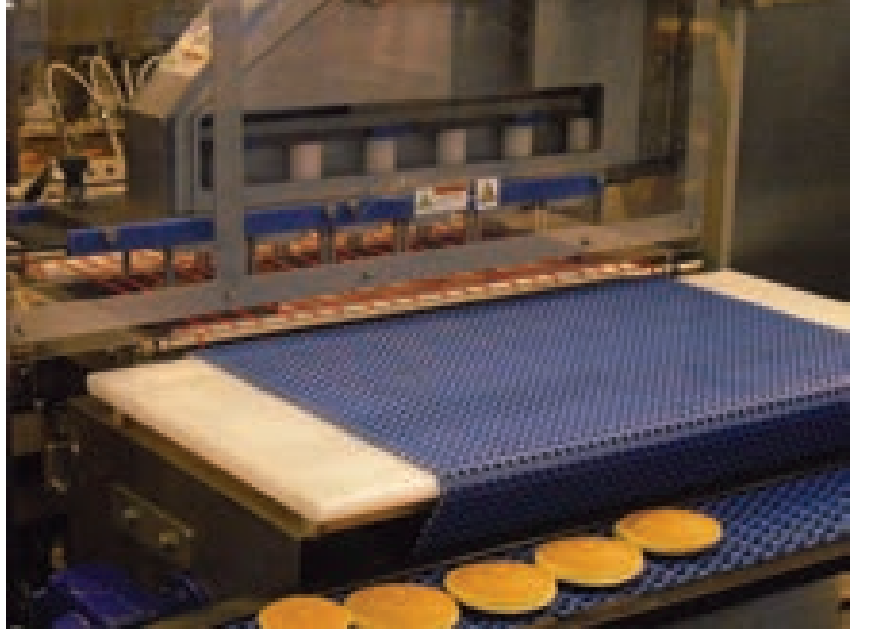

*Özel üretim yapılır./On request special production is available.

MODEL: 927-928/929-930 KAYNAKLI VE KİLİTLİ DÜZ HASIR BANT/WELDED & LOCKED MODULAR CONVEYOR BELTS

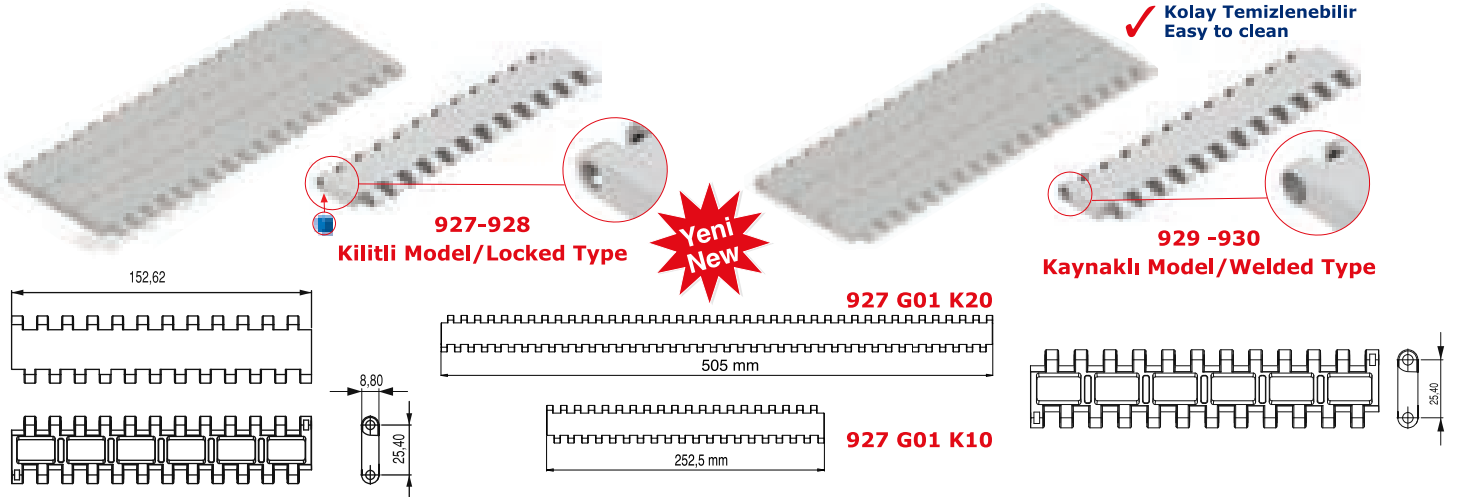

P	RM	M	152,4	PIN	Bant Dayanımı Chain Strength (N/m)	Kg/m ²	Stok Kod Stock Code		m
							Kilitli Model/Locked Type	Kaynaklı Model/Welded Type	
25,4	-	PBT+FR	152,4	SS	35200	9,25	927 GS4 K..	-	m
				ZN	35200	9,20	927 GM4 K..	-	
		PP		PA	21600	5,75	927 G01 K..	929 G01 K..	
				PP	20400	5,50	928 G01 K..	930 G01 K..	
		POM		PA	35200	7,85	927 G02 K..	929 G02 K..	
				PP	34100	7,60	928 G02 K..	930 G02 K..	
		PE		PA	21600	5,75	927 G03 K..	929 G03 K..	
				PP	20400	5,50	928 G03 K..	930 G03 K..	

MODEL: 931-932/933-934 KAYNAKLI VE KİLİTLİ DOĞRUSAL SÜZGEÇLİ HASIR BANT/WELDED & LOCKED LINEAR FILTER CONVEYOR BELTS

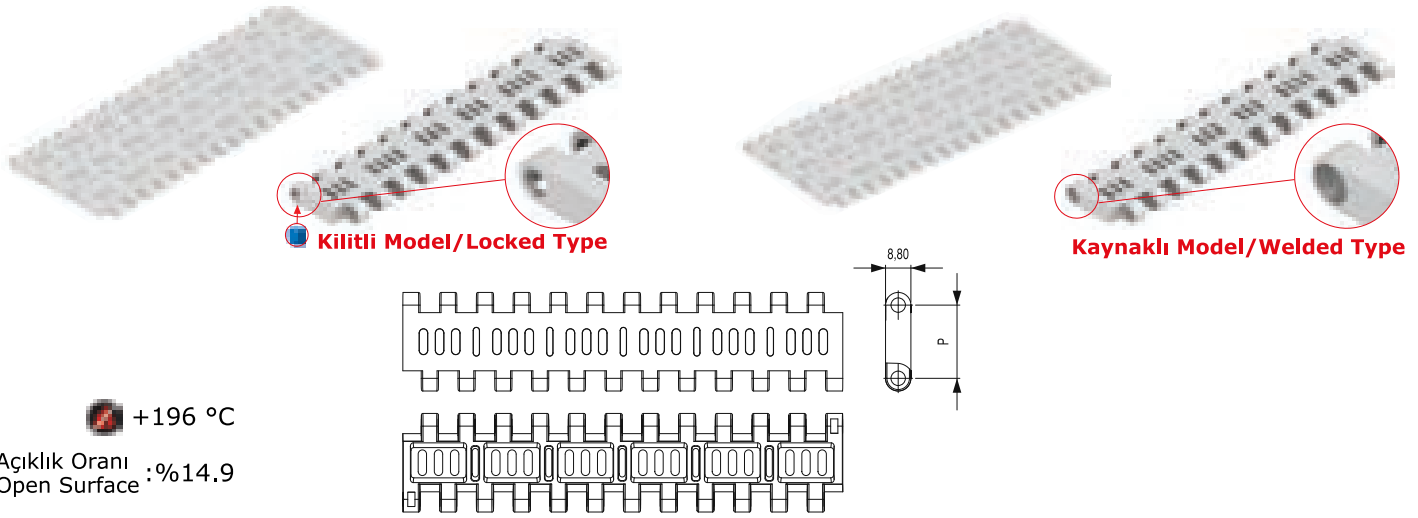

P	RM	M	152,4	PIN	Bant Dayanımı Chain Strength (N/m)	Kg/m ²	Stok Kod Stock Code		m
							Kilitli Model/Locked Type	Kaynaklı Model/Welded Type	
25,4	-	PBT+FR	152,4	SS	35200	9,10	931 GS4 K..	-	m
				ZN	35200	9,05	931 GM4 K..	-	
		PP		PA	21600	5,65	931 G01 K..	933 G01 K..	
				PP	20400	5,40	932 G01 K..	934 G01 K..	
		POM		PA	35200	7,75	931 G02 K..	933 G02 K..	
				PP	34100	7,50	932 G02 K..	934 G02 K..	
		PE		PA	21600	5,65	931 G03 K..	933 G03 K..	
				PP	20400	5,40	932 G03 K..	934 G03 K..	

*933-**934: Detaylı bant genişlikleri ve stok kod bilgilerine

*933-**934: For more belt width and stock code details, you can look



sayfalarından ulaşabilirsiniz. at this pages

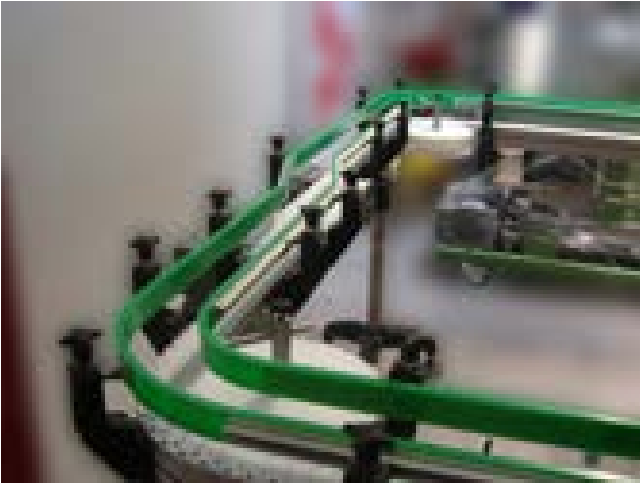
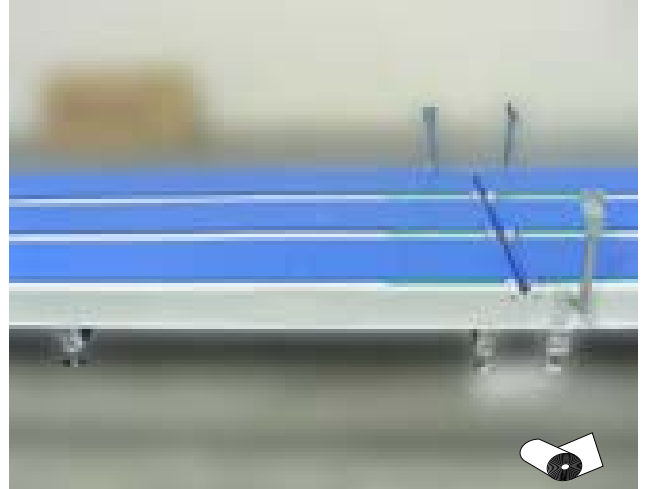
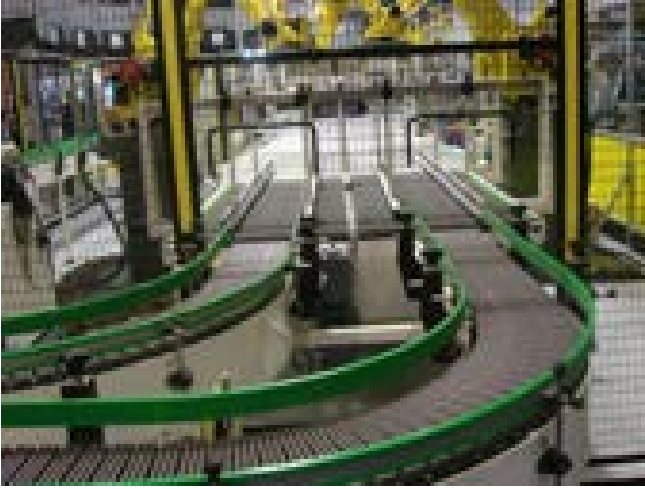

*Özel üretim yapılır./On request special production is available.

MODEL: 935-936 DAİRESEL SÜZGEÇLİ HASIR BANT/935-936 CIRCULAR FILTER CONVEYOR BELTS

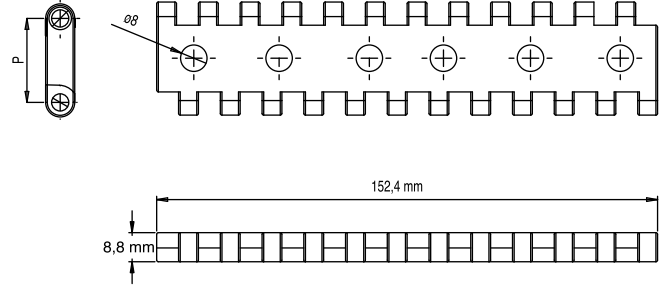
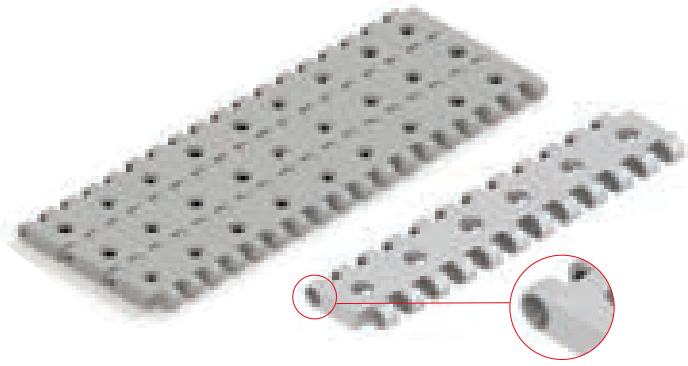

Açıklık Oranı :%9.8
Open Surface

P	RM	M		PIN	Bant Dayanımı Chain Strength (N/m)	Kg/m ²	Stok Kod Stock Code Kaynaklı Model	
25,4	-	PP	152,4	PA	21600	5,75	935 G01 K06*	m
				PP	20400	5,50	936 G01 K06**	
				PA	35200	7,85	935 G02 K06*	
				PP	34100	7,60	936 G02 K06**	
				PA	21600	5,75	935 G03 K06*	
				PP	20400	5,50	936 G03 K06**	

*935-**936: Detaylı bant genişlikleri ve stok kod bilgilerine

*935-**936: For more belt width and stock code details, you can look



sayfalarından ulaşabilirsiniz.
at this pages

MODEL: 937-938 KAYNAKLI PİMLİ HASIR TAŞIMA BANT TARAKLI GÖTÜRÜCÜ/CLEAT FOR MODULAR CONVEYOR BELTS WITH WELDED PIN

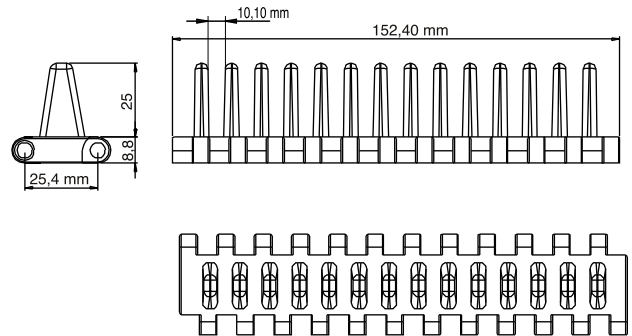
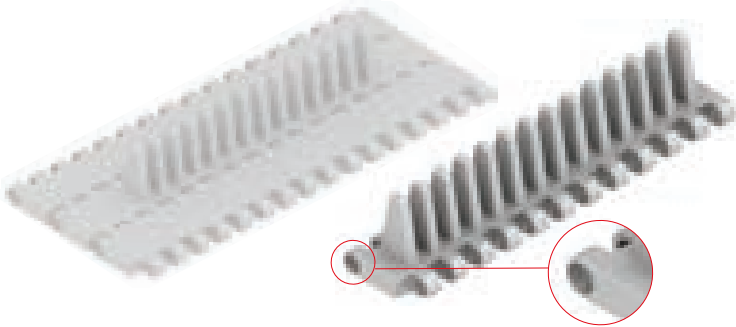

P	RM	M		PIN	Bant Dayanımı Chain Strength (N/m)	Kg/m ²	Stok Kod Stock Code Kaynaklı Model	
25,4	-	PP	152,4	PA	21600	5,65	937 G01 K06*	m
				PP	20400	5,40	938 G01 K06**	
				PA	35200	7,75	937 G02 K06*	
				PP	34100	7,50	938 G02 K06**	
				PA	21600	5,65	937 G03 K06*	
				PP	20400	5,40	938 G03 K06**	

*937-**938: Detaylı bant genişlikleri ve stok kod bilgilerine

*937-**938: For more belt width and stock code details, you can look



sayfalarından ulaşabilirsiniz.
at this pages

*Özel üretim yapılır./On request special production is available.



MODEL: 939-940/941-942 KAYNAKLI PİMLİ HASIR TAŞIMA BANT GÖTÜRÜCÜ/CLEAT FOR MODULAR CONVEYOR BELTS WITH WELDED PIN

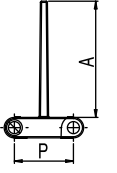
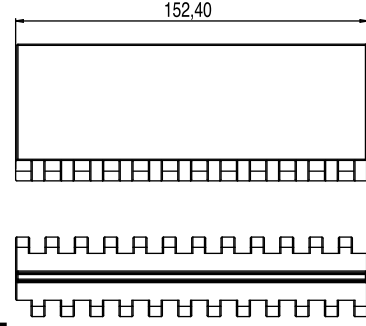

A	P	M	RRRRRRRRRRRR TTTTTTTTTTTTTTTT	Stok Kod Stock Code	
25	25,4	PA6.6	152,4	939 G04 T01	100
		PP		939 G01 T01	
		POM		939 G02 T01	
		PE		939 G03 T01	
50	25,4	PA6.6	152,4	939 G04 T02	
		PP		939 G01 T02	
		POM		939 G02 T02	
		PE		939 G03 T02	
75	25,4	PA6.6	152,4	939 G04 T03	
		PP		939 G01 T03	
		POM		939 G02 T03	
		PE		939 G03 T03	
100	25,4	PA6.6	152,4	939 G04 T04	
		PP		939 G01 T04	
		POM		939 G02 T04	
		PE		939 G03 T04	



*939-941**940-942: Detaylı bant genişlikleri ve stok kod bilgilerine

*939-941**940-942: For more belt width and stock code details, you can look



sayfalarından ulaşabilirsiniz. at this pages

381 TAHRİK DİŞLİSİ/SPLIT SPROCKETS (MODEL 928)



928, 931
962, 822

Yeni
New



Yeni
New

DF	DE	DP	Stok Kod/Stock Code	
ø25	97	86	381 D25 Z12	8
40	97	86	381 D40 Z12	
40	120	109	381 D40 Z15	
60	120	109	381 D60 Z15	
40	148	137	381 D40 Z18	
60	148	137	381 D60 Z18	

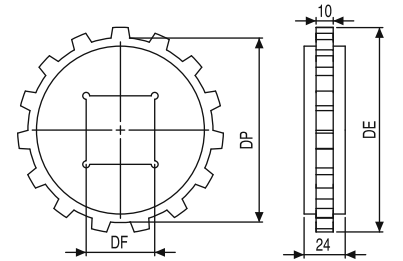

UYARI 1-2/WARNING 1-2→SAYFA C/PAGE C

*Özel üretim yapılır./On request special production is available.

25,4 KOLAY TEMİZLENEBİLİR HASIRBANT/EASY TO CLEAN CONVEYOR BELTS

M

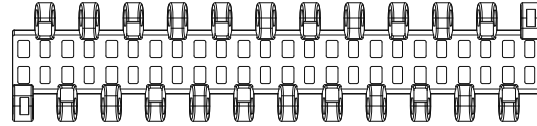
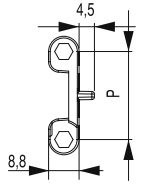
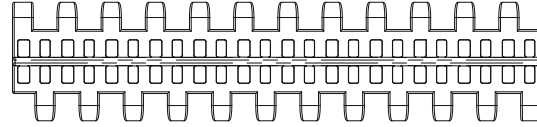

P	M	Yüzey Açıklığı Open Area	Genişlik Width	Kg/m ²	Stok Kod Stock Code
25,4	PP	%20	152,4	4,40	920 B01 K..
25,4	POM	%20	152,4	6,10	920 B02 K..

25,4 BÜYÜK SÜZGEÇLİ KOLAY TEMİZLENEBİLİR HASIRBANT/EASY TO CLEAN CONVEYOR BELTS

M

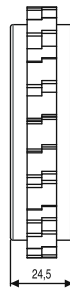
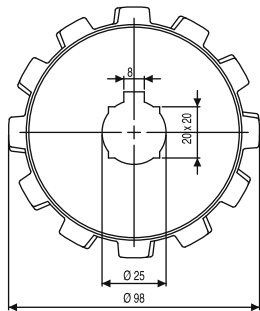
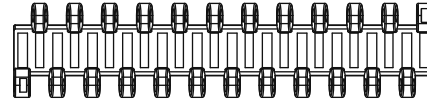
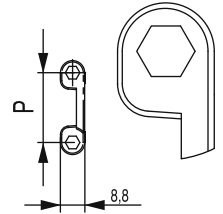
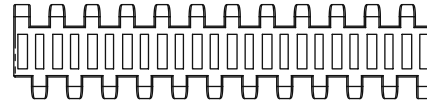

P	M	Yüzey Açıklığı Open Area	Genişlik Width	Kg/m ²	Stok Kod Stock Code
25,4	PP	%26	152,4	3,60	922 B01 K..
25,4	POM	%26	152,4	5,28	922 B02 K..



*Özel üretim yapılır./On request special production is available.



25,4 KÜÇÜK SÜZGEÇLİ KOLAY TEMİZLENEBİLİR HASIRBANT/EASY TO CLEAN CONVEYOR BELTS

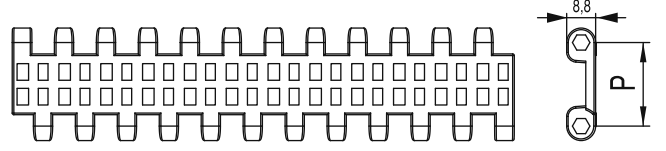
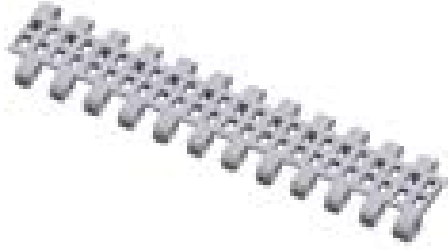

P	M	Yüzey Açıklığı Open Area	Genişlik Width	Kg/m ²	Stok Kod Stock Code
25,4	PP	%20	152,4	3,70	921 B01 K..
	POM	%20	152,4	5,10	921 B02 K..



25,4 KOLAY TEMİZLENEBİLİR HASIRBANT/EASY TO CLEAN CONVEYOR BELTS

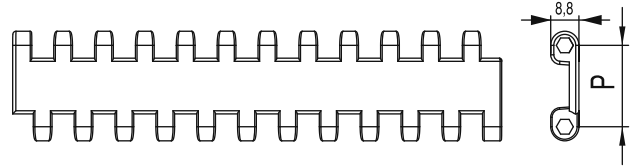

P	M	Yüzey Açıklığı Open Area	Genişlik Width	Kg/m ²	Stok Kod Stock Code
25,4	PP	-	152,4	4,40	923 B01 K..
	POM	-	152,4	5,98	923 B02 K..



*Özel üretim yapılır./On request special production is available.

822 ÇOK MENTEŞELİ BAKLA HASIRBANT/MOLD TO WIDTH

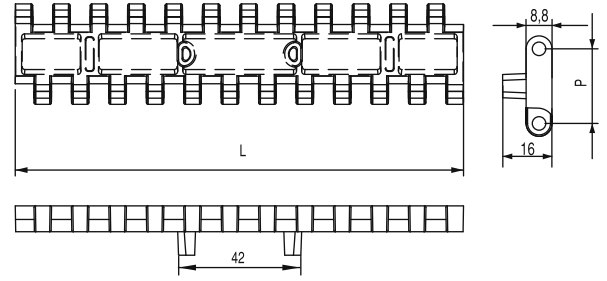
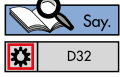

P	M	Bant Geniřliđi Belt Width L mm	PIN	Bant Mukaveti Belt Strength Kg	Çalıřma Sıcaklıđı Temperature Range °C	Kg/m ²	Stok Kod Stock Code	Maliyet Cost
25,4	POM	82,3	Ø 4,6 PA	112	-30 / +85	0,60	822 G02 082	**
	PP		Ø 4,6 PP	58	+1 / +100	0,55	822 G01 082	*
25,4	POM	114,3	Ø 4,6 PA	252	-30 / +85	0,83	822 G02 114	**
	PP		Ø 4,6 PP	120	+1 / +100	0,77	822 G01 114	*
25,4	POM	152,4	Ø 4,6 PA	308	-30 / +85	1,10	822 G02 152	**
	PP		Ø 4,6 PP	160	+1 / +100	1,00	822 G01 152	*
25,4	POM	190,5	Ø 4,6 PA	345	-30 / +85	1,38	822 G02 190	***
	PP		Ø 4,6 PP	185	+1 / +100	1,25	822 G01 190	**
38,1	SS	82,3	Ø 4,6 AISI 304	350	-80 / 425	3,14	SS 815 TAB K325	****
		114,3				3,88	SS 815 TAB K450	****
		190,5				5,87	SS 815 TAB K750	*****

965 IZGARALI (SÜZGEÇLİ) 27.2 mm HASIRBANT/OPEN GRID MODULER CONVEYOR BELT

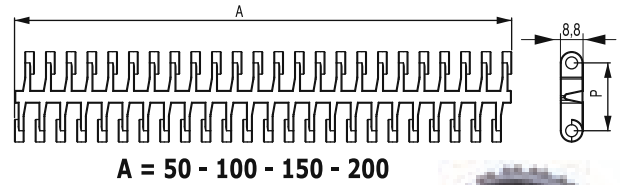
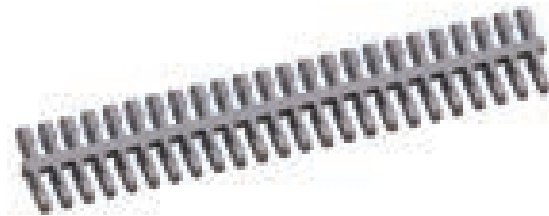

P	M	Yüzey Açıklıđı Open Area	Bant Dayanımı Belt Strength N/m	Kg/m ²	Stok Kod Stock Code
27,2	PP	%38	18.000	3,70	965 B01 K..
27,2	POM	%38	20.000	5,60	965 B02 K..



961 YÜKSELTİLMİŐ IZGARALI (SÜZGEÇLİ) 27.2 mm HASIRBANT/RAISED OPEN GRID MODULER CONVEYOR BELT

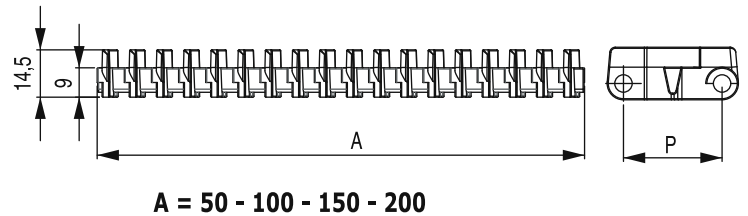
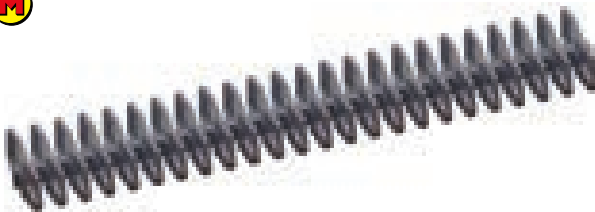

P	M	Yüzey Açıklıđı Open Area	Bant Dayanımı Belt Strength N/m	Kg/m ²	Stok Kod Stock Code
27,2	PP	%38	18.000	5,20	961 B01 K..
27,2	POM	%38	20.000	8,20	961 B02 K..



*Özel üretim yapılır./On request special production is available.

**380 ABD 219
Z19 Ø162**



962 MAZGALLI HASIRBANT/OPEN GRID MODULAR CONVEYOR BELTS

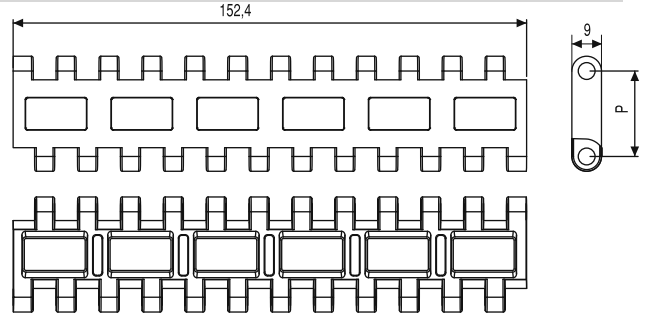
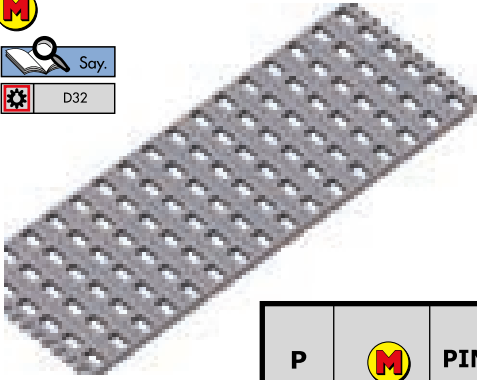
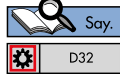

P	M	PIN	Yüzey Açıklığı Open Area	Genişlik Width	Kg/m ²	Stok Kod Stock Code
25,4	PP	PA	%28	152,4	4,95	962 G01 K..
	POM	PA	%28	152,4	6,99	962 G02 K..
	PE	PA	%28	152,4	5,02	962 G03 K..
	PA FR	SS	%28	152,4	10,21	963 GS4 K..
	PA FR	ZN	%28	152,4	10,10	963 GM4 K..
	PA FR	PA	%28	152,4	5,75	963 G04 K..

947 KAUÇUK GÖTÜRÜCÜLÜ HASIRBANT/MINI RIB RUBBER MODULAR CONVEYOR BELTS

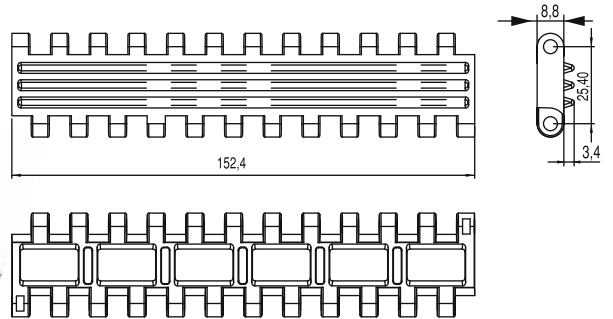
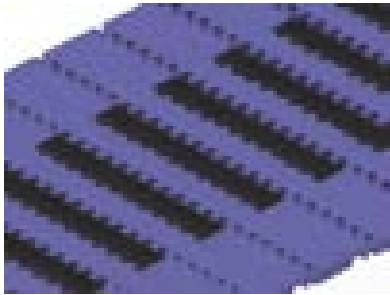

P	Yüzey Açıklığı Open Area	Genişlik Width	Stok Kod Stock Code
25,4	-	152,4	947 S01 K00



*Özel üretim yapılır./On request special production is available.



940 DÖNÜŞLÜ HASIR BANT/SPIRAL CONVEYOR BELTS

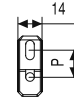
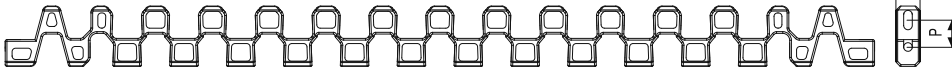
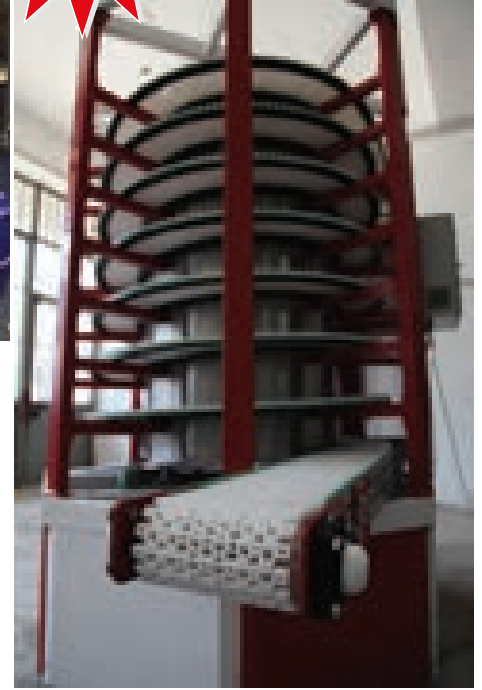
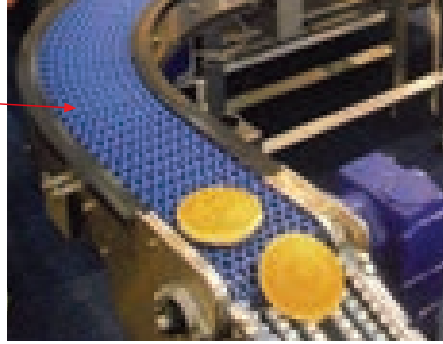
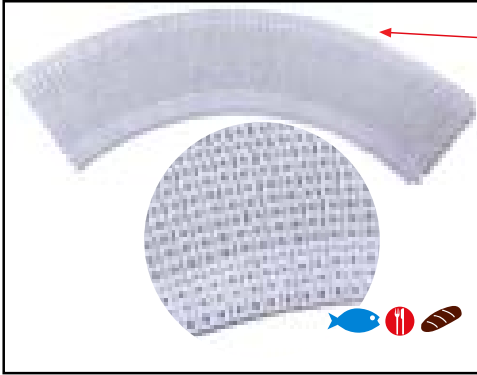
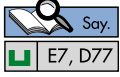

Z=12			
Z	Stok Kod/Stock Code		
12	380 ABB 112	8	
* 18	380 ABB 118		
* 20	380 ABB 120		

Bantın kullandığı endüstri alanları:

The belt is suitable for usage in industries:

- 1-Unlu Mamüller/Bakery
- 2-Bisküvit ve çikolata/Biscuits and chocolate.
- 3-Kahvaltılık mamüller/Snacks
- 4-Mesrubat sektörü
Bottling of juices, water, beer, soft drinks, e.t.c.
- 5-Süt endüstrisi/Milk products
- 6-Konserve endüstrisi/Conservations.
- 7-Meyve ve sebze sektörü
Processing and packaging of fruits and vegetables.
- 8-Et ürünleri/Meat processing.
- 9-Deniz ürünleri/Sea food processing
- 10-İlaç endüstrisi/Pharmaceuticals
- 11-Dondurulmuş gıdalar/Refrigerators

STOK KOD STOCK CODE	BANT GENİŞLİĞİ BELT WIDTH (mm)
940 BO1 K08	210
940 BO1 K10	243
940 BO1 K11	276
940 BO1 K12	309
940 BO1 K13	342
940 BO1 K14	375
940 BO1 K16	408
940 BO1 K17	441
940 BO1 K18	474
940 BO1 K20	507
940 BO1 K21	540
940 BO1 K22	573
940 BO1 K23	606
940 BO1 K25	639
940 BO1 K26	672
940 BO1 K27	705
940 BO1 K29	738
940 BO1 K30	771
940 BO1 K31	804
940 BO1 K33	837
940 BO1 K34	870
940 BO1 K35	903
940 BO1 K36	936
940 BO1 K38	969
940 BO1 K39	1002
940 BO1 K40	1035
* 940 BO1 K..

	M	PP	POM
Renk Colour (2*)		grey / gri 	beyaz / white
Taşıyacağı Yük Strength max (Kg/m)	Doğrusal Straight	1700	2500
	Dönüş Curve	150	210
Sıcaklık Temperature (°C)		+1 +105	-46 +93
Açıklan Open Surface		50%	50%
Adım Pitch (mm) P		25,4	25,4
Ağırlık Weight (Kg/m2)		5,2	7,5
Dişli'den Olan Uzaklık Distances between the sprockets Z12		54,6 mm	54,6 mm
Stok Kod Stock Code		940 B01 K00	940 B02 K00
	br	m ²	m ²

Hoşgörü/Tolerance ± % 0,7

*Özel üretim yapılır./On request special production is available.

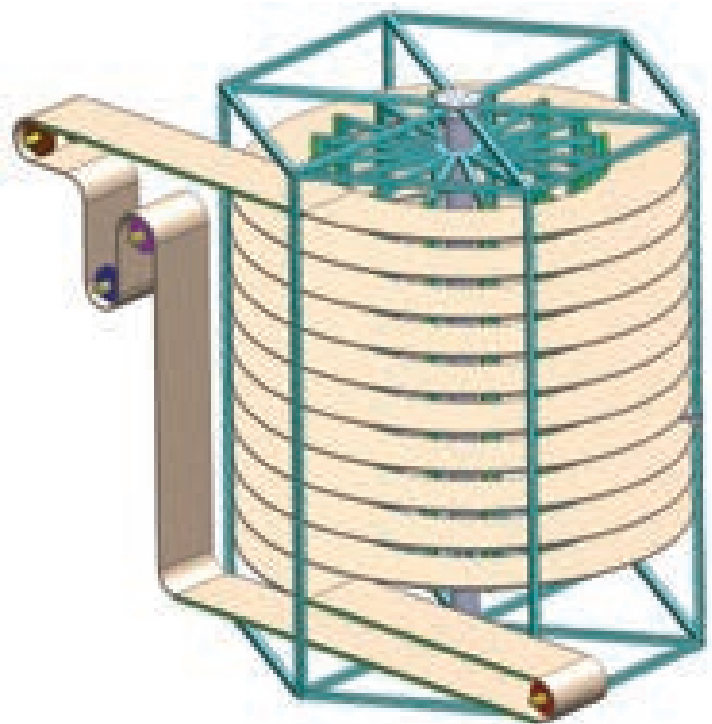
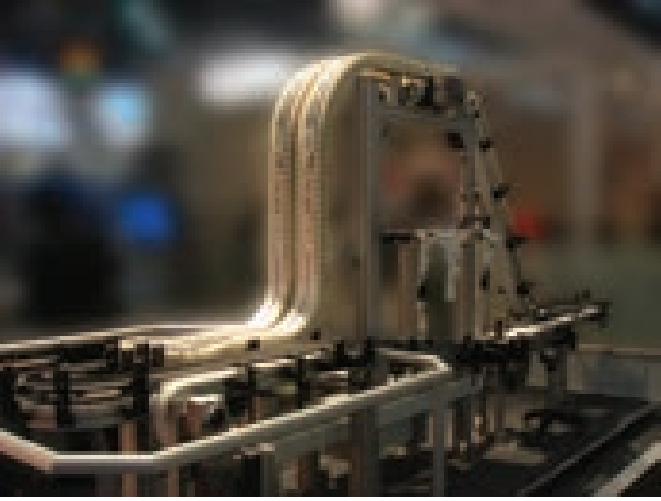

*Özel üretim yapılır./On request special production is available.

832 - 842 IZGARALI (SÜZGEÇ) HASIR BANT/GRID MODULAR CONVEYOR BELTS

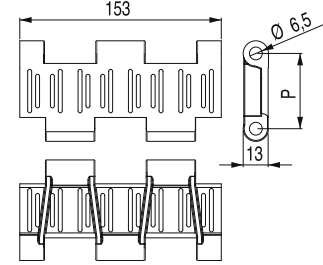

mm							
P	RM		PIN	Bant Dayanımı Chain Strength (N/m)	Kg/m ²	Stok Kod Stock Code	br
38,1	-	 %22 Açıklık (Open Surface)	POM	7850	6.5	832 G03 K06*	m
			PP	6750		842 G03 K06**	
			POM	21500	9	832 G02 K06*	
			PP	17500		842 G02 K06**	
			POM	9500	6	832 G01 K06*	
			PP	8750		842 G01 K06**	
38,1	-	 %22 Açıklık (Open Surface)	POM	7850	6.5	832 M03 K06*	
			PP	6750		842 M03 K06**	
			POM	21500	9	832 M02 K06*	
			PP	17500		842 M02 K06**	
			POM	9500	6	832 M01 K06*	
			PP	8750		842 M01 K06**	
38,1	-	 %22 Açıklık (Open Surface)	POM	7850	6.5	832 B03 K06*	
			PP	6750		842 B03 K06**	
			POM	21500	9	832 B02 K06*	
			PP	17500		842 B02 K06**	
			POM	9500	6	832 B01 K06*	
			PP	8750		842 B01 K06**	

*832-**842: Detaylı bant genişlikleri ve stok kod bilgilerine

*832-**842: For more belt width and stock code details, you can look



sayfalarından ulaşabilirsiniz.
at this page



*Özel üretim yapılır./On request special production is available.



833 SÜRTÜNMELİ HASIR DÜZ TAŞIMA BANTI/FRICTION TOP CHAINS (SPECIAL SERIES)

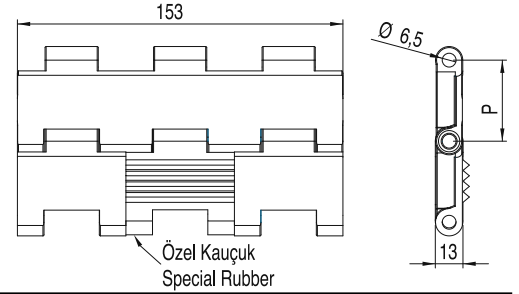
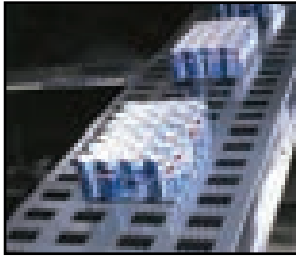

mm								
P	RM		PIN	Bant Dayanımı Chain Strength (N/m)	Kg/m ²	Stok Kod Stock Code	br	
38,1	-		POM	7850	6.5	833 G03 K06*	m	
			PP	6750		843 G03 K06**		
			POM	21500	9	833 G02 K06*		
			PP	17500		843 G02 K06**		
			POM	9500	6	833 G01 K06*		
			PP	8750		843 G01 K06**		
38,1	-		POM	7850	6.5	833 M03 K06*		
			PP	6750		843 M03 K06**		
			POM	21500	9	833 M02 K06*		
			PP	17500		843 M02 K06**		
			POM	9500	6	833 M01 K06*		
			PP	8750		843 M01 K06**		
38,1	-		POM	7850	6.5	833 B03 K06*		
			PP	6750		843 B03 K06**		
			POM	21500	9	833 B02 K06*		
			PP	17500		843 B02 K06**		
			POM	9500	6	833 B01 K06*		
			PP	8750		843 B01 K06**		

*833-**843: Detaylı bant genişlikleri ve stok kod bilgilerine

*833-**843: For more belt width and stock code details, you can look



sayfalarından ulaşabilirsiniz. at this page

850 GEÇİŞ TARAĞI/TRANSFERS COMB

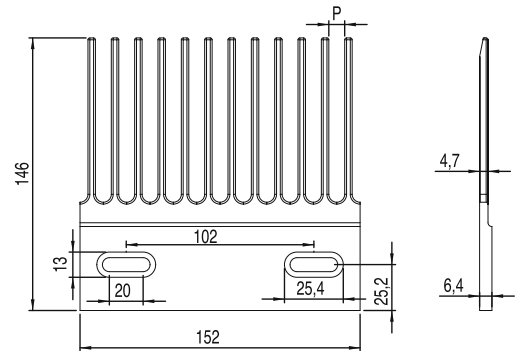
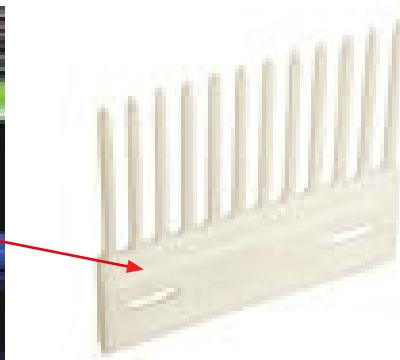
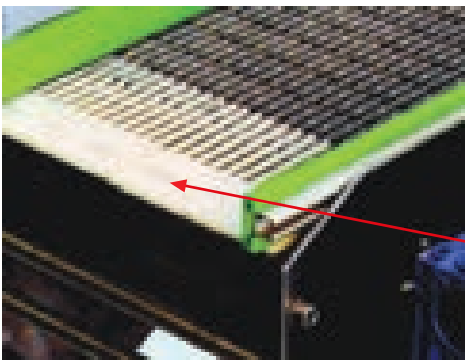

mm.							
P		Kullanılan Bantlar For Chains	Kg	Stok Kod Stock Code	br		
8,5		831 / 841	0,093	850 B02 152	20		
8,5		831 / 841	0,065	850 B01 152			

*Özel üretim yapılır./On request special production is available.

855 TAŞIMA BANT ENGELİ/CLEAT BELTS

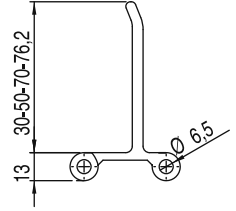
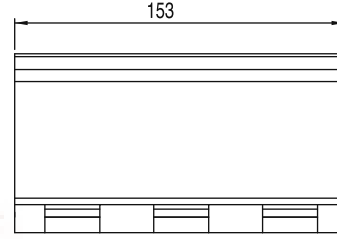
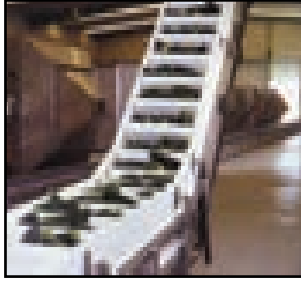

mm.							
P	RM	M	Kullanılan Bantlar For Chains	Bant Dayanımı Chain Strength (N/m)	Kg/m	Stok Kod Stock Code	br
38,1	-	Polietilen Gri Polyethylene Grey		830 - 831 832 - 833 Seri/Series	0,80	855 G03 153	mm
						860 G03 153	
						855 G02 153	
		860 G02 153					
		855 G01 153					
		860 G01 153					
38,1	-	Poliasetal Gri Polyacetal Grey		830 - 831 832 - 833 Seri/Series	0,80	855 M03 153	mm
						860 M03 153	
						855 M02 153	
		860 M02 153					
		855 M01 153					
		860 M01 153					
38,1	-	Polipropilen Gri Polypropylene Grey		830 - 831 832 - 833 Seri/Series	0,80	855 B03 153	mm
						860 B03 153	
						855 B02 153	
		860 B02 153					
		855 B01 153					
		860 B01 153					

868 YAN KULAK/SIDE GUARDS

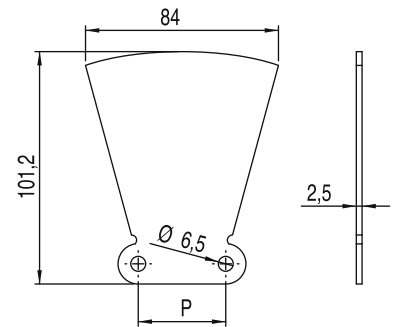

mm.							
P	RM	M	Kullanılan Bantlar For Chains	PIN	Kg	Stok Kod Stock Code	br
38,1	-	Polipropilen/Polypropylene	830 - 831 832 - 833 Seri/Series	POM	0,022	868 G01 038	100
				PP		870 G01 038	
		Poliasetal/Polyacetal		POM		868 G02 038	
				PP		870 G02 038	
		Polietilen/Polyethylene		POM		868 G03 038	
				PP		870 G03 038	

*Özel üretim yapılır./On request special production is available.



830 - 835 HASIR DÜZ TAŞIMA BANTI/MODULAR FLAT TOP CONVEYOR BELTS

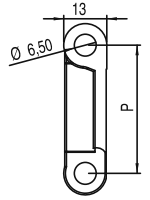
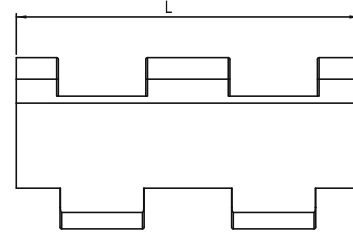

mm								
P	RM	L		PIN	Bant Dayanımı Chain Strength (N/m)	Kg/m ²	Stok Kod Stock Code	br
38,1	-	51	Polietilen Beyaz Polyethylene White	POM	7850	5,5	830 B03 K02*	m
		102		PP	6750		835 B03 K02**	
		153		POM	7850		830 B03 K04*	
				PP	6750		835 B03 K04**	
		153		POM	7850		830 B03 K06*	
				PP	6750		835 B03 K06**	
38,1	-	51	Poliasetal Mavi Polyacetal Blue	POM	21500	7,8	830 M02 K02*	
		102		PP	17500		835 M02 K02**	
		153		POM	21500		830 M02 K04*	
				PP	17500		835 M02 K04**	
		153		POM	21500		830 M02 K06*	
				PP	17500		835 M02 K06**	
38,1	-	51	Polipropilen Gri Polypropylene Grey	POM	9500	5,5	830 G01 K02*	
		102		PP	8750		835 G01 K02**	
		153		POM	9500		830 G01 K04*	
				PP	8750		835 G01 K04**	
		153		POM	9500		830 G01 K06*	
				PP	8750		835 G01 K06**	

*830-**835: Detaylı bant genişlikleri ve stok kod bilgilerine

*830-**835: For more belt width and stock code details, you can look



sayfalarından ulaşabilirsiniz. at this page

831 - 841 KABURGA KANALLI HASIR TAŞIMA BANTI/RAISED RIP MODULAR CONVEYOR BELTS

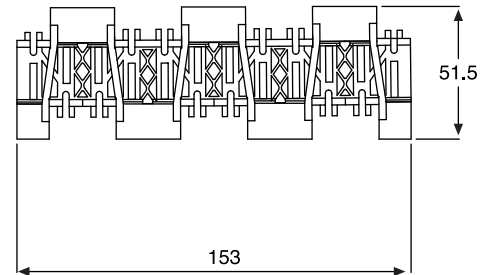
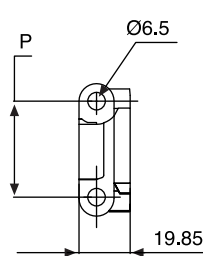
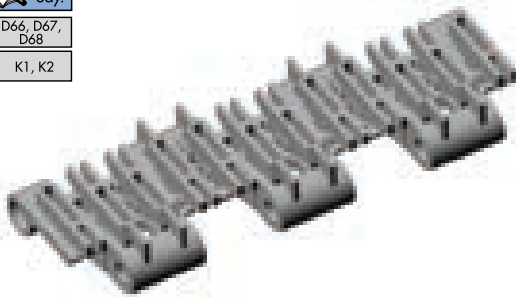

mm.								
P	RM		PIN	Bant Dayanımı Chain Strength (N/m)	Kg/m ²	Stok Kod Stock Code	br	
38,1	-	Polietilen Polyethylene	POM	7850	8	831 X03 K06*	m	
			PP	6750		841 X03 K06**		
		Poliasetal Polyacetal	POM	21500	11	831 X02 K06*		
			PP	17500		841 X02 K06**		
		Polipropilen Polypropylene	POM	9500	7,5	831 X01 K06*		
			PP	8750		841 X01 K06**		

*831-**841: Detaylı bant genişlikleri ve stok kod bilgilerine

*831-**841: For more belt width and stock code details, you can look



sayfalarından ulaşabilirsiniz. at this page

*Özel üretim yapılır./On request special production is available.

840 - 845 HASIR DÜZ TAŞIMA BANTI/MODULAR FLAT TOP CONVEYOR BELTS

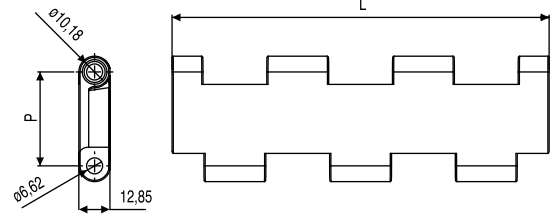
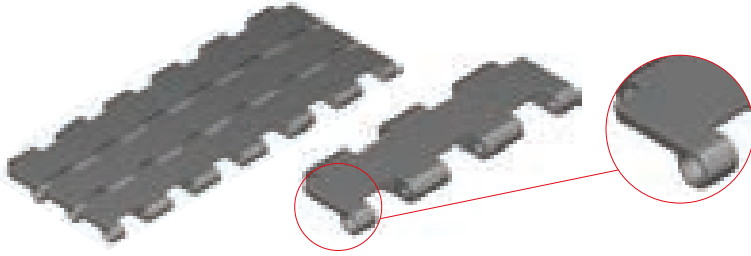

mm												
P	RM	L		PIN	Bant Dayanımı Chain Strength (N/m)	Kg/m ²	Stok Kod Stock Code	br				
38,1	-	51	Polietilen Beyaz Polyethylene White	PA	7850	5,5	840 B03 K02*	m				
		102		PP	6750		845 B03 K02**					
		153		PA	7850		840 B03 K04*					
				PP	6750		845 B03 K04**					
		38,1		-	51		Poliasetal Mavi Polyacetal Blue		PA	21500	7,8	840 M02 K02*
					102				PP	17500		845 M02 K02**
153	PA		21500		840 M02 K04*							
	PP		17500		845 M02 K04**							
38,1	-		51		Polipropilen Gri Polypropylene Grey	PA			9500	5,5		840 G01 K02*
			102			PP			8750			845 G01 K02**
		153	PA	9500		840 G01 K04*						
			PP	8750		845 G01 K04**						
		153	PA	9500		840 G01 K06*						
			PP	8750		845 G01 K06**						

852 - 862 IZGARALI (SÜZGEÇ) HASIR BANT/GRID MODULAR CONVEYOR BELTS

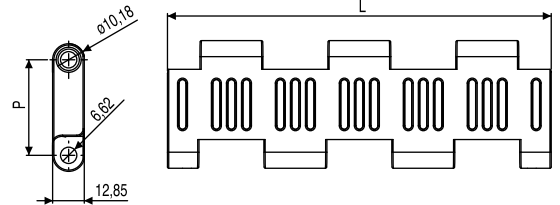
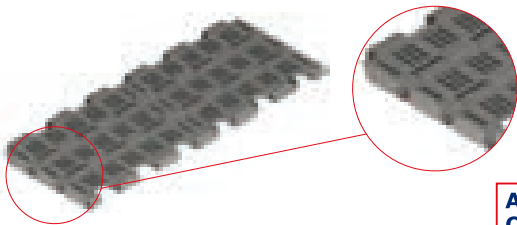

Açıklık Oranı :%17
Open Surface :%17

mm												
P	RM	L		PIN	Bant Dayanımı Chain Strength (N/m)	Kg/m ²	Stok Kod Stock Code	br				
38,1	-	51	Polietilen Beyaz Polyethylene White	PA	7850	5,5	852 B03 K02*	m				
		102		PP	6750		862 B03 K02**					
		153		PA	7850		852 B03 K04*					
				PP	6750		862 B03 K04**					
		38,1		-	51		Poliasetal Mavi Polyacetal Blue		PA	21500	7,8	852 M02 K02*
					102				PP	17500		862 M02 K02**
153	PA		21500		852 M02 K04*							
	PP		17500		862 M02 K04**							
38,1	-		51		Polipropilen Gri Polypropylene Grey	PA			9500	5,5		852 G01 K02*
			102			PP			8750			862 G01 K02**
		153	PA	9500		852 G01 K04*						
			PP	8750		862 G01 K04**						
		153	PA	9500		852 G01 K06*						
			PP	8750		862 G01 K06**						

*852-**862: Detaylı bant genişlikleri ve stok kod bilgilerine

*852-**862: For more belt width and stock code details, you can look



sayfalarından ulaşabilirsiniz.
at this page

*Özel üretim yapılır./On request special production is available.

960 KABURGALI KANALLI HASIR BANT / 959-960 RAISED RIB MODULAR BELT

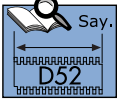

Yeni
New

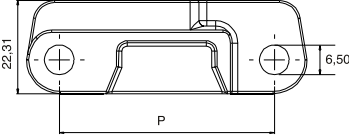
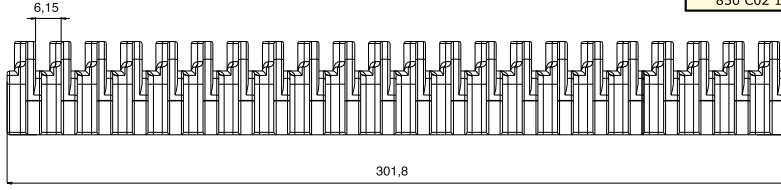
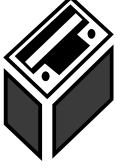
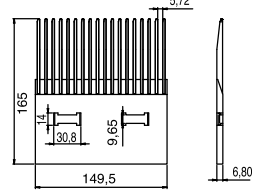
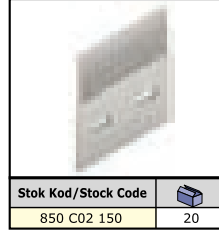
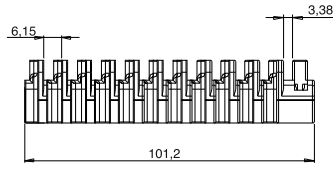
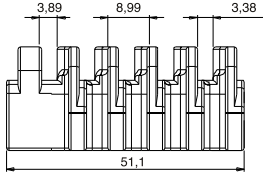

Stok Kod/Stock Code	20
850 C02 150	20

P	°C	M	PIN	Bant Dayanımı Chain Strength (N/m)	Kg/m ²	Stok Kod Stock Code		
50,8	+1 +100	PP	51,1	PP	33000	11,3	960 G01 K02	m ²
			101,2	PP	33000	11,3	960 G01 K04	
			301,8	PP	33000	11,3	960 G01 K12	
	-30 +85	POM	51,1	PP/PA	38000	15,9	960 M02 K02	
			101,2	PP/PA	38000	15,9	960 M02 K04	
			301,8	PP/PA	38000	15,9	960 M02 K12	
	-10 +90	PE	51,1	PP	30000	10,6	960 B03 K02	
			101,2	PP	30000	10,6	960 B03 K04	
			301,8	PP	30000	10,6	960 B03 K12	

→ %16.5 Açıklık/ Open Surface

380 TAHRİK DİŞLİSİ/380 DRIVING SPROCKETS

Güçlendirilmiş Polyamid/Reinforced Polyamide (PA)

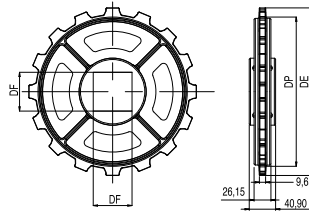
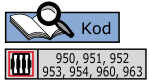

DF	DE	DP	50,8 mm (2")	Stok Kod/Stock Code	8
40	131,5	109,5		380 G40 Z08	8
60	131,5	109,5		380 G60 Z08	
40	197	176,5		380 G40 Z12	
60	197	176,5		380 G60 Z12	
40	265	240		380 G40 Z16	
60	265	240		380 G60 Z16	

*Özel üretim yapılır./On request special production is available.

950-951 YILDIZ SERİSİ HASIR DÜZ TAŞIYICI BANT/STAR SERIE MODULAR CONVEYOR BELTS

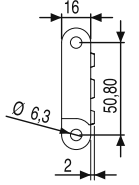
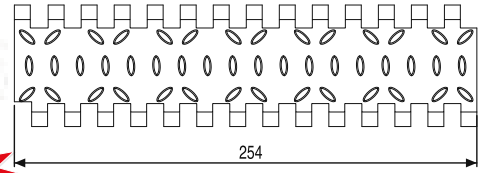

mm								
P	RM	M		PIN	Bant Dayanımı Chain Strength (N/m)	Kg/m ²	Stok Kod Stock Code	br
50,8	-	PP	254	PA	29950	12,0	950 G01 K10*	m
				PP	26500	11,6	951 G01 K10**	
				PA	39950	15,4	950 G02 K10*	
				PP	36500	14,6	951 G02 K10**	
				PA	29950	15,4	950 G03 K10*	
				PP	26500	14,6	951 G03 K10**	

963 YUMRU DESENLİ HASIRBANT/NUB TOP MODULAR CONVEYOR BELTS

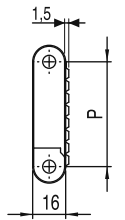
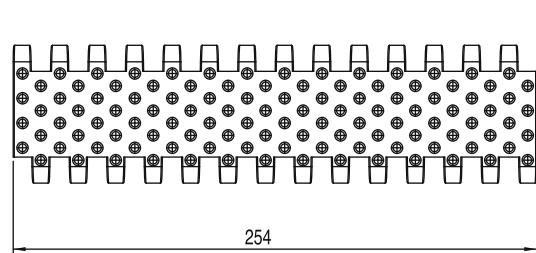
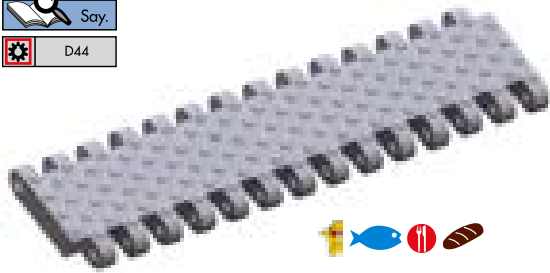

mm								
P	RM	M		PIN	Bant Dayanımı Chain Strength (N/m)	Kg/m ²	Stok Kod Stock Code	br
50,8	-	PP	254	PA	29950	12,0	963 G01 K10*	m
				PP	26500	11,6	963 G01 K10**	
				PA	39950	15,4	963 G02 K10*	
				PP	36500	14,6	963 G02 K10**	
				PA	29950	15,4	963 G03 K10*	
				PP	26500	14,6	963 G03 K10**	

*950-**951-963: Detaylı bant genişlikleri ve stok kod bilgilerine

*950-**951-963: For more belt width and stock code details, you can look



sayfalarından ulaşabilirsiniz.
at this page

*Özel üretim yapılır./On request special production is available.

952-953 HASIR DÜZ TAŞIYICI BANTI/MODULAR FLAT TOP CONVEYOR BELTS

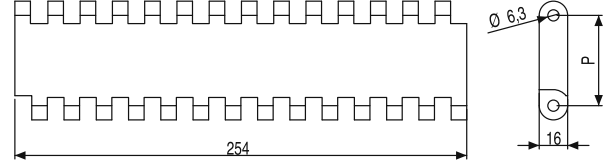

mm.								
P	RM	M		PIN	Bant Dayanımı Chain Strength (N/m)	Kg/m ²	Stok Kod Stock Code	br
50,8	-	PP POM PE	254	POM	29950	12,0	952 G01 K10*	m
				PP	26500	11,6	953 G01 K10**	
				POM	39950	15,4	952 G02 K10*	
				PP	36500	14,6	953 G02 K10**	
				POM	29950	15,4	952 G03 K10*	
				PP	26500	14,6	953 G03 K10**	

*952-**953: Detaylı bant genişlikleri ve stok kod bilgilerine

*952-**953: For more belt width and stock code details, you can look



sayfalarından ulaşabilirsiniz.
at this page

954-955 HASIR SÜZGEÇLİ TAŞIYICI BANTI/MODULAR GRID CONVEYOR BELTS



Yeni
New

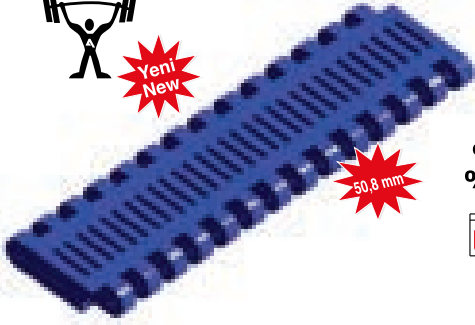

50,8 mm

%20 Açık Alan
%20 Open Area

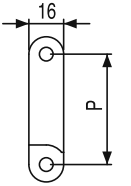
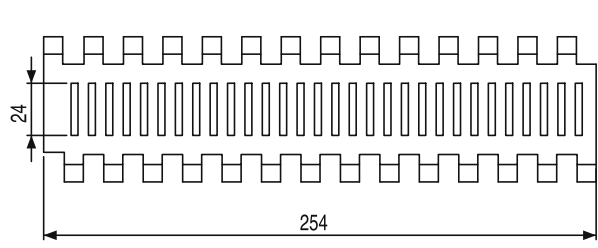

mm.								
P	RM	M		PIN	Bant Dayanımı Chain Strength (N/m)	Kg/m ²	Stok Kod Stock Code	br
50,8	-	PP POM PE	254	POM	29950	12,0	954 G01 K10*	m
				PP	26500	11,6	955 G01 K10**	
				POM	39950	15,4	954 G02 K10*	
				PP	36500	14,6	955 G02 K10**	
				POM	29950	15,4	954 G03 K10*	
				PP	26500	14,6	955 G03 K10**	

*954-**955: Detaylı bant genişlikleri ve stok kod bilgilerine

*954-**955: For more belt width and stock code details, you can look



sayfalarından ulaşabilirsiniz.
at this page

*Özel üretim yapılır./On request special production is available.

943-944 ENGELLİ GÖTÜRÜCÜ/CLEAT BELTS

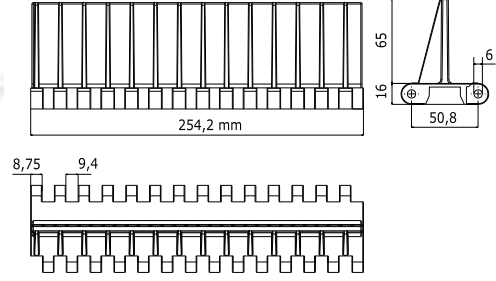
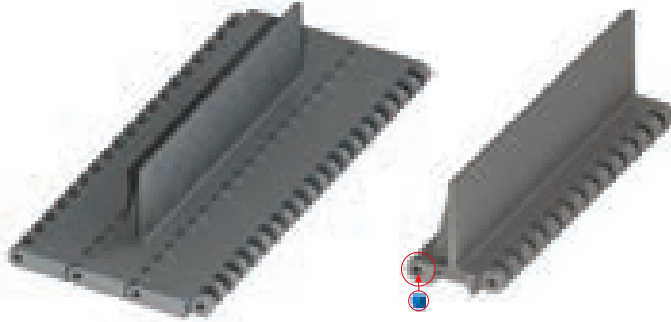

P	RM	M		PIN	Bant Dayanımı Chain Strength (N/m)	Kg/m ²	Stok Kod Stock Code	
50,8	-	PBT	254,2	SS	35200	9,10	943 G04 K06*	m ²
				PA6	21600	5,65	943 G01 K06*	
				PP	20400	5,40	944 G01 K06**	
				PA6	35200	7,75	943 G02 K06*	
		POM		PP	34100	7,50	944 G02 K06**	
				PA6	21600	5,65	943 G03 K06*	
				PP	20400	5,40	944 G03 K06**	
				PE				

958 MAKARA BİLYALI HASIR BANT / BALL MODULAR BELT

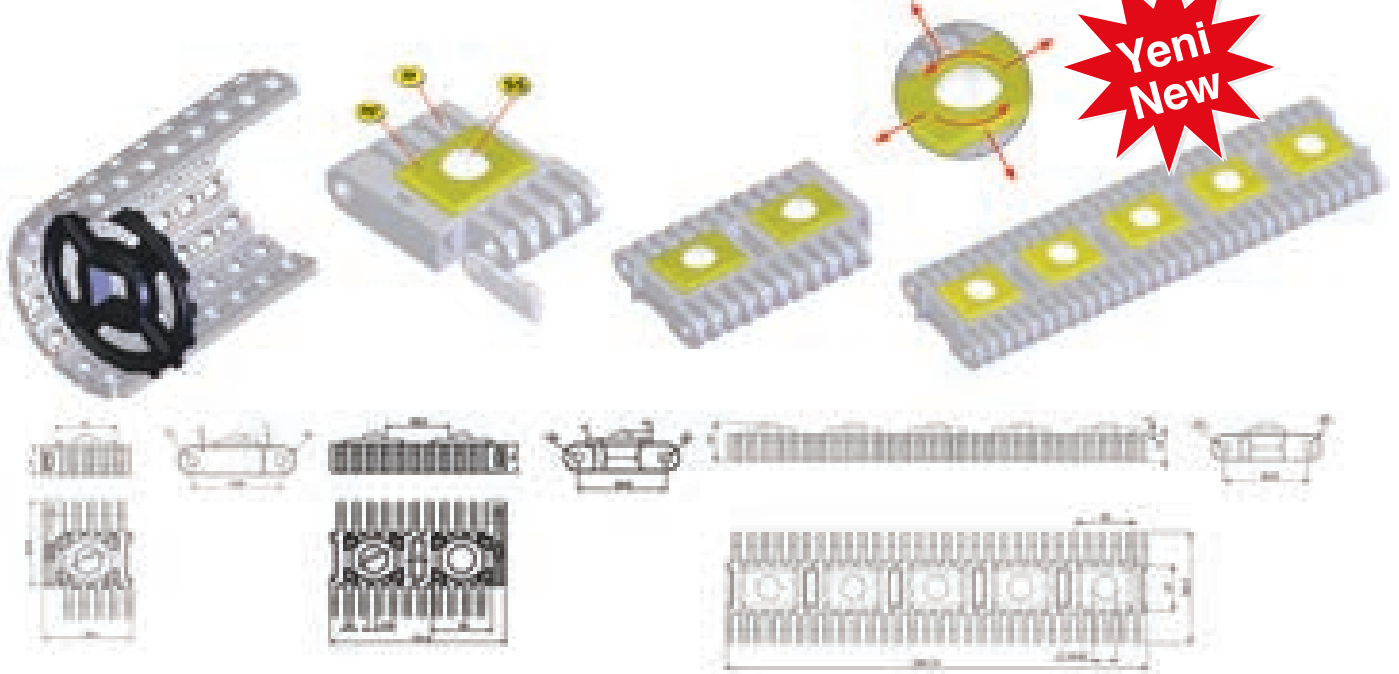

P	RM	M		PIN	Bant Dayanımı Chain Strength (N/m)	Kg/m ²	Stok Kod Stock Code	
50,8	-	PP	50,80	PP	33000	20,4	958 B01 K02*	m ²
			101,60	PP	33000	20,4	958 B01 K04*	
			254,75	PP	33000	20,4	958 B01 K10*	

*%25 Açıkalan/Open Surface +1°C / +90°C

*958: Detaylı bant genişlikleri ve stok kod bilgilerine

*958: For more belt width and stock code details, you can look



D48, D49

sayfalarından ulaşabilirsiniz.
at this page

*Özel üretim yapılır./On request special production is available.

956 BİRİKTİRME MAKARALI HASIR BANTI/ACCUMULATION ROLLER BELTS

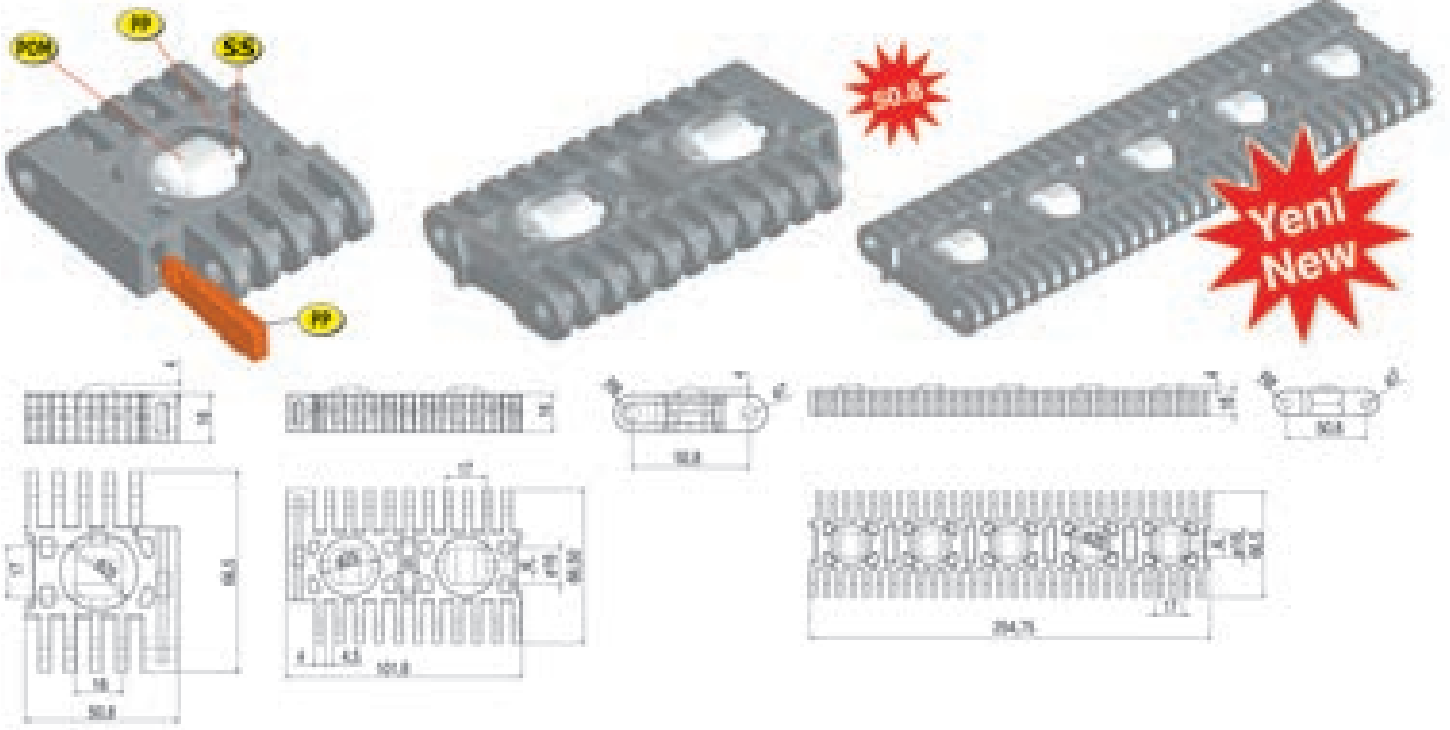

P	RH			PIN	Bant Dayanımı Chain Strength (N/m)	Kg/m ²	Stok Kod/Stock Code	
50,8		PP	153	PP	33000	11,2	956-957 G01 K06	m ²
			204	PP	33000	11,2	956-957 G01 K07	
			255	PP	33000	11,2	956-957 G01 K08	
			306	PP	33000	11,2	956-957 G01 K09	
			357	PP	33000	11,2	956-957 G01 K10	
			408	PP	33000	11,2	956-957 G01 K11	
			459	PP	33000	11,2	956-957 G01 K...	

YIYIYIYIYI *%44 Açıklan/Open Surface | +1°C / +100°C

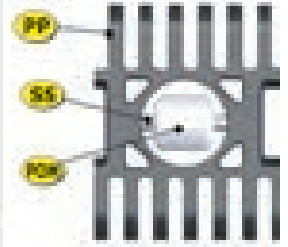

382 (Z16) TAHRİK DİŞLİSİ/SPLIT SPROCKETS (MODEL 956-957)

Güçlendirilmiş Polyamid/Reinforced Polyamide (PA)

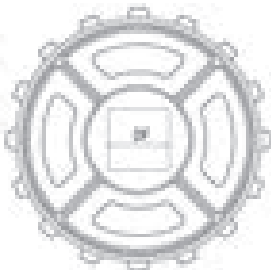

Z	DF	Kg	Stok Kod/Stock Code	
16	40	0,587	382 D40 Z16	8
16	60	0,556	382 D60 Z16	8

*Özel üretim yapılır./On request special production is available.

957 AKTARMA MARAKALI HASIR BANT/TRANSFER ROLLER BELTS

Yeni
New

50.8

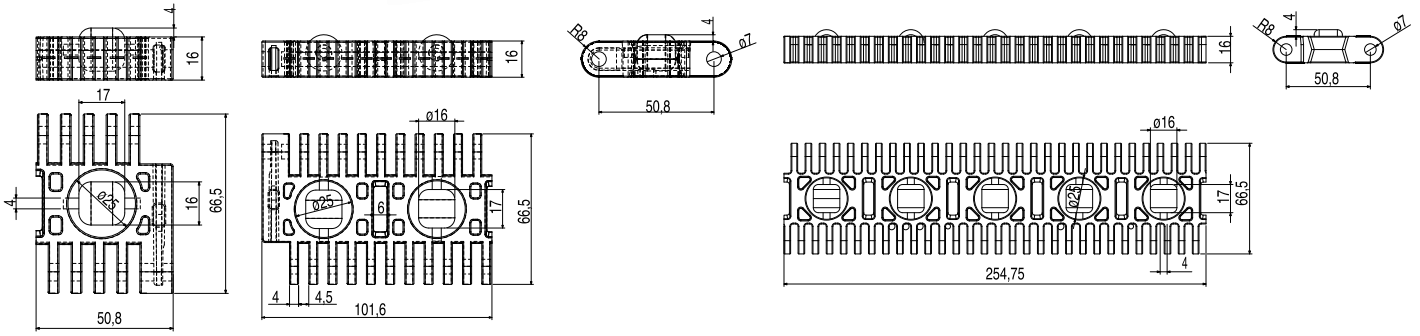

mm									
153	462	771	1080	1389	1698	2007	2316	2625	2934
204	513	822	1131	1440	1749	2058	2367	2676	2985
255	564	873	1182	1491	1800	2109	2418	2727	3036
306	615	924	1233	1542	1851	2160	2469	2778	3087
357	666	975	1284	1593	1902	2211	2520	2829	3138
408	717	1026	1335	1644	1953	2262	2571	2880

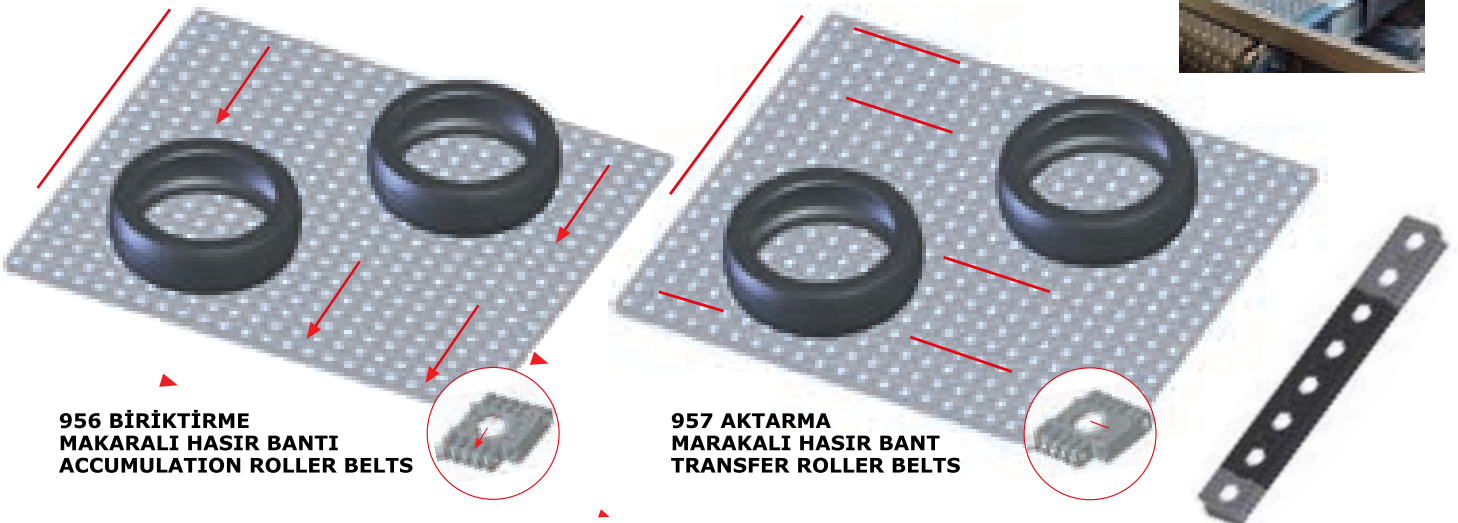
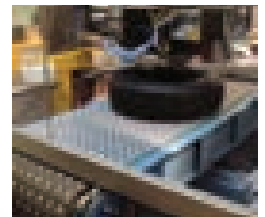

956 BİRİKTİRME
MAKARALI HASIR BANTI
ACCUMULATION ROLLER BELTS

957 AKTARMA
MARAKALI HASIR BANT
TRANSFER ROLLER BELTS

*Özel üretim yapılır./On request by manufactured.



830 - 835 HASIR DÜZ TAŞIMA BANTI
MODULAR FLAT TOP CONVEYOR BELTS

832 - 842 IZGARALI (SÜZGEÇ) HASIR BANT
GRID MODULAR CONVEYOR BELTS

831 - 841 KABURGA KANALLI HASIR TAŞIMA BANTI
RAISED RIP MODULAR CONVEYOR BELTS

833 - 843 SÜRTÜNMELİ HASIR DÜZ TAŞIMA BANTI
FRICTION TOP CHAINS (SPECIAL SERIES)

G: Gri/Grey
M: Mavi/Blue
B: Beyaz/White

830 X03 K02

BANT GENİŞLİĞİ/BELT WIDTH (mm)
25.4 x 2 = 50.8 = 2" → 51 mm

BANT MALZEMESİ/BELT MATERIAL
03: Polietilen/Polyethylene
02: Poliasetal/Polyacetal
01: Polipropilen/Polypropylene

STOK KOD STOCK CODE	W: BANT GENİŞLİĞİ BELT WIDTH (mm)
830 X03 K02	051
830 X03 K04	102
830 X03 K06	153
830 X03 K08	204
830 X03 K10	255
830 X03 K12	306
830 X03 K14	357
830 X03 K16	408
830 X03 K18	459
830 X03 K20	510
830 X03 K22	561
830 X03 K24	612
830 X03 K26	663
830 X03 K28	714
830 X03 K30	765
830 X03 K32	816
830 X03 K34	867
830 X03 K36	918
830 X03 K38	969
830 X03 K40	1020
830 X03 K42	1071
830 X03 K44	1122
830 X03 K46	1173
830 X03 K48	1224
830 X03 K50	1275
830 X03 K52	1326
830 X03 K54	1377
830 X03 K56	1428
830 X03 K58	1479
830 X03 K60	1530
830 X03 K62	1581
830 X03 K64	1632
830 X03 K66	1683
830 X03 K68	1734
830 X03 K70	1785
830 X03 K72	1836
830 X03 K74	1887
830 X03 K76	1938
830 X03 K78	1989
830 X03 K80	2040
830 X03 K82	2091
830 X03 K84	2142
830 X03 K86	2193
830 X03 K88	2244
830 X03 K90	2295
830 X03 K92	2346
830 X03 K94	2397
830 X03 K96	2448
830 X03 K98	2499



W: Bant Genişliği/Belt Width

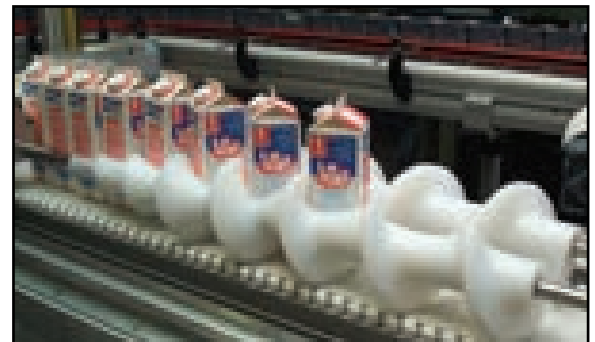
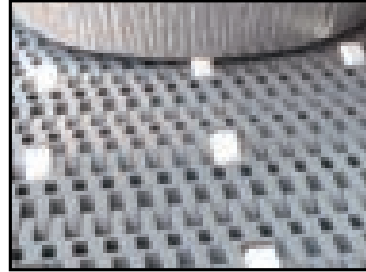

Hoşgörü/Tolerance +/- 0,007

KONVEYÖR BANT İSTEK FORMU/CONVEYOR BELT'S ORDER FORM

FİRMA/COMPANY:	TARİH/DATE:
ADRES/ADDRESS:	BELGEGEÇER/FAX:
İLGİLİ KİŞİ/PERSON IN CHARGE:	TELEFON NU./PHONE NO.:

BANT ÖZELLİKLERİ/BELT'S SPECIFICATIONS

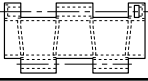
830 - 835 HASIR DÜZ TAŞIMA BANTI/MODULAR FLAT TOP CONVEYOR BELTS		
MODEL	BANT TİPİ/ BELT'S TYPE	PIN
830		POM
835		PP

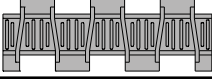

832 - 842 IZGARALI (SÜZGEÇ) HASIR BANT/GRID MODULAR CONVEYOR BELTS		
MODEL	BANT TİPİ/ BELT'S TYPE	PIN
832		POM
842		PP

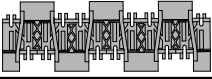

831 - 841 KABURGA KANALLI HASIR TAŞIMA BANTI/RAISED RIP MODULAR CONVEYOR BELTS		
MODEL	BANT TİPİ/ BELT'S TYPE	PIN
831		POM
843		PP



833 - 843 SÜRTÜNMELİ HASIR DÜZ TAŞIMA BANTI/FRICTION TOP CHAINS (SPECIAL SERIES)		
MODEL	BANT TİPİ/ BELT'S TYPE	PIN
833		POM
843		PP

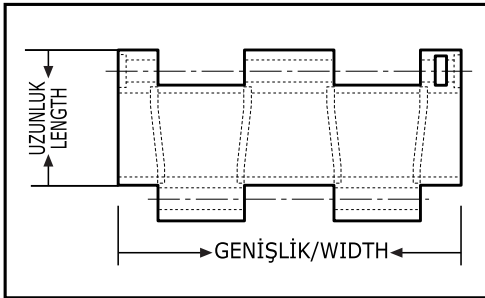

MALZEME MATERIAL	
PE	<input type="checkbox"/>
PP	<input type="checkbox"/>
POM	<input type="checkbox"/>

RENK/COLOUR	
BEYAZ/WHITE	<input type="checkbox"/>
GRİ/GREY	<input type="checkbox"/>
MAVİ/BLUE	<input type="checkbox"/>

- PE** : Poliasetal/Polyacetal
- PP** : Polipropilen/Polypropylene
- POM** : Polietilen/Polyethylene

ÖLÇÜLER/DIMENSIONS
GENİŞLİK/WIDTH.....mm
UZUNLUK/LENGTH.....mm

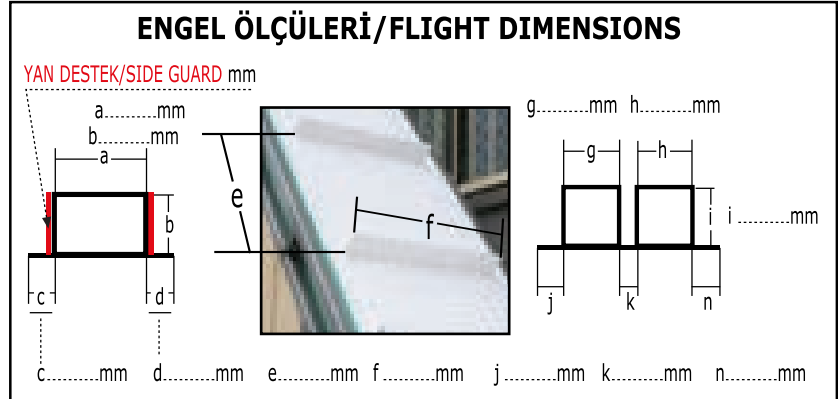

İstekleriniz için bu belgeyi  +90 212 567 14 16 yada pazarlama@alhan-cagri.com ile gönderiniz
For your request, you can send to this document



946 (12.7 mm-1/2") - 928 (25.4 mm-1") HASIR BANT
MODULAR CONVEYOR BELTS

950-951 YILDIZ SERİSİ HASIR DÜZ TAŞIYICI BANT
STAR SERIE MODULAR CONVEYOR BELTS

952-953 HASIR DÜZ TAŞIYICI BANTI
MODULAR FLAT TOP CONVEYOR BELTS

954-955 HASIR SÜZGEÇLİ TAŞIYICI BANTI
MODULAR GRID CONVEYOR BELTS

G: Gri/Grey
M: Mavi/Blue
B: Beyaz/White

BANT GENİŞLİĞİ/BELT WIDTH (mm)
25.4 x 2 = 50.8 = 2" → 51 mm

BANT MALZEMESİ/BELT MATERIAL
03: Polietilen/Polyethylene
02: Poliasetal/Polyacetal
01: Polipropilen/Polypropylene

STOK KOD STOCK CODE	BANT GENİŞLİĞİ BELT WIDTH (mm)
* 928 X01 K01	25,4
928 X01 K02	51,3
928 X01 K03	76,7
928 X01 K04	102,7
928 X01 K05	127,8
928 X01 K06	153,7
928 X01 K07	179,4
928 X01 K08	205
928 X01 K09	230,6
928 X01 K10	256,4
928 X01 K11	282,2
928 X01 K12	308
928 X01 K13	333
928 X01 K14	359
928 X01 K15	385
928 X01 K16	410
928 X01 K17	436
928 X01 K18	462
928 X01 K19	487
928 X01 K20	513
928 X01 K21	539
928 X01 K22	564
928 X01 K23	590
928 X01 K24	616
928 X01 K25	641
928 X01 K26	666
928 X01 K27	692
928 X01 K28	717
928 X01 K29	743
928 X01 K30	770
928 X01 K31	795
928 X01 K32	820
928 X01 K33	846
928 X01 K34	872
928 X01 K35	897
928 X01 K36	923
928 X01 K37	949
928 X01 K39	975
928 X01 K40	1000
928 X01 K41	1026
* 928 X01 K...

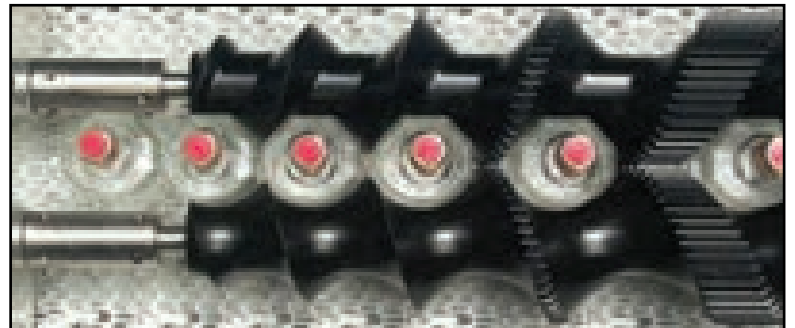
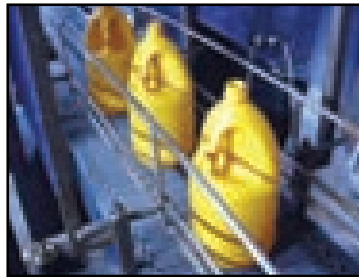

Hoşgörü/Tolerance +/- 0,007

*Özel üretim yapılır./On request special production is available.

KONVEYÖR BANT İSTEK FORMU/CONVEYOR BELT'S ORDER FORM

FİRMA/COMPANY:	TARİH/DATE:
ADRES/ADDRESS:	BELGEGEÇER/FAX:
İLGİLİ KİŞİ/PERSON IN CHARGE:	TELEFON NU./PHONE NO.:

BANT ÖZELLİKLERİ/BELT'S SPECIFICATIONS

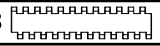
945 (12.7 mm-1/2") - 928 (25.4 mm-1") HASIR BANT/MODULAR CONVEYOR BELTS		
MODEL	BANT TİPİ/ BELT'S TYPE	PIN
<input type="checkbox"/> 945 <input type="checkbox"/> 928	945  928 	PP

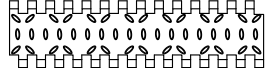

950-951 YILDIZ SERİSİ HASIR DÜZ TAŞIYICI BANT/STAR SERIE MODULAR CONVEYOR BELTS		
MODEL	BANT TİPİ/ BELT'S TYPE	PIN
950		POM
951		PP



952-953 HASIR DÜZ TAŞIYICI BANTI/MODULAR FLAT TOP CONVEYOR BELTS		
MODEL	BANT TİPİ/ BELT'S TYPE	PIN
952		POM
953		PP



954-955 HASIR SÜZGEÇLİ TAŞIYICI BANTI/MODULAR GRID CONVEYOR BELTS		
MODEL	BANT TİPİ/ BELT'S TYPE	PIN
954		POM
955		PP

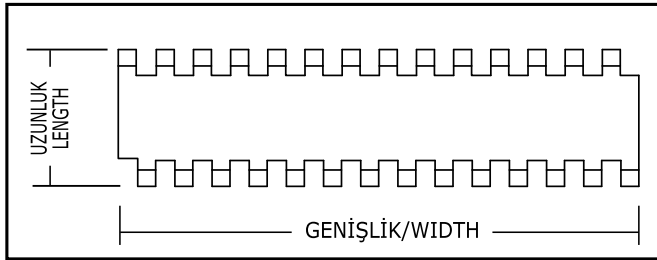

MALZEME MATERIAL	
PE	
PP	
POM	

RENK/COLOUR	
BEYAZ/WHITE	
GRİ/GREY	
MAVİ/BLUE	

- POM** : Poliasetal/Polyacetal
- PP** : Polipropilen/Polypropylene
- PE** : Polietilen/Polyethylene

ÖLÇÜLER/DIMENSIONS
GENİŞLİK/WIDTH.....mm
UZUNLUK/LENGTH.....mm

ENGEL ÖLÇÜLERİ/FLIGHT DIMENSIONS

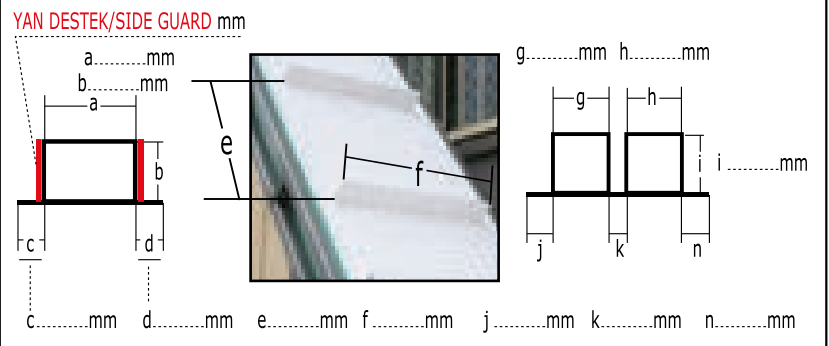

İstekleriniz için bu belgeyi  +90 212 567 14 16 yada pazarlama@alhan-cagri.com ile gönderiniz
For your request, you can send to this document

300 AVARA KASNAK (TALAŞLI İMALAT TEK PARÇA)/STANDART IDLER WHEELS

M Döküm Polyamid/Cast Polyamide

Kod

815, 815G,
820, 880, 881

K1, K2

Ağır Tip
Heavy Type

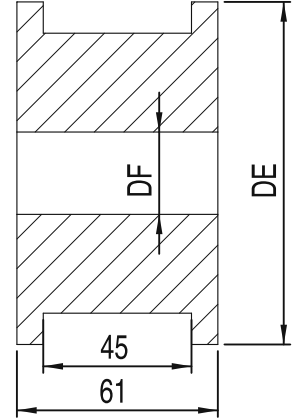
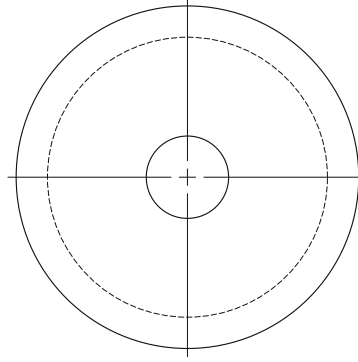

Z-İmalat Şekil Manufacture	DE	DF	Kg	Stok Kod Stock Code	
17-Talaşlı/Sawdust	104,0	25	0,40	300 İTİ 117	6
		30		300 İTİ 217	
19-Talaşlı/Sawdust	117,0	25	0,50	300 İTİ 119	
		30		300 İTİ 219	
21-Talaşlı/Sawdust	129,0	25	0,60	300 İTİ 121	
		30		300 İTİ 212	
23-Talaşlı/Sawdust	141,0	25	0,70	300 İTİ 123	
		30		300 İTİ 223	
25-Talaşlı/Sawdust	153,0	25	0,90	300 İTİ 125	
		30		300 İTİ 225	

302 AVARA KASNAK (KALIPLI İMALAT TEK PARÇA)/SPLIT IDLER WHEELS

M Güçlendirilmiş Polyamid/Reinforced Polyamide

Kod

815, 815G,
820, 880, 881

K1, K2

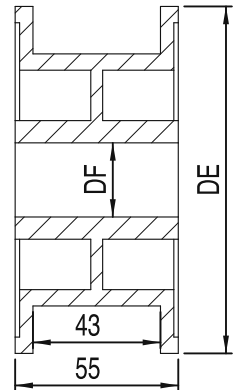
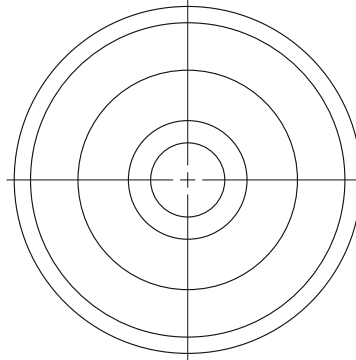
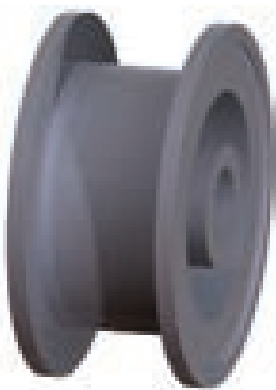

Z-İmalat Şekil Manufacture	DE	DF	Kg	Stok Kod Stock Code	
19-Kalıplı/Molding	117	25	0,20	302 019 103	6
		30		302 019 203	

*Özel üretim yapılır./On request special production is available.

303 AVARA KASNAK (KALIPLI İMALAT TEK PARÇA)/STANDART IDLER WHEELS

M Polyamid (PA6) + Molibden Sülfür/ Reinforced Polyamide

Kod

815, 815G,
820, 880, 881

K1, K2

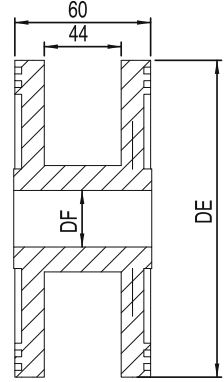
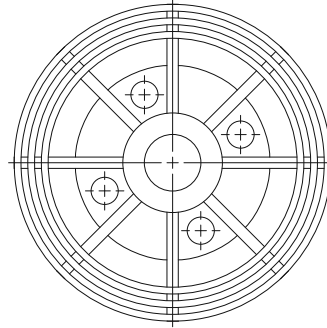

Z-İmalat Şekil Manufacture	DE	DF	Kg	Stok Kod Stock Code	
23-Kalıplı/Molding	117	25	0,50	303 223 103	8
		30		303 223 203	

304 AVARA KASNAK (KALIPLI İMALAT İKİ PARÇA)/SPLIT IDLER WHEELS

M Asetal/Acetal (POM)

Kod

815, 815G,
820, 880, 881

K1, K2

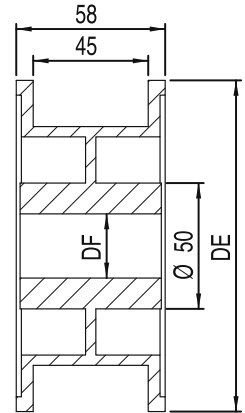
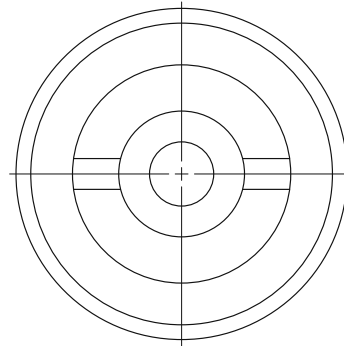

Z-İmalat Şekil Manufacture	DE	DF	Kg	Stok Kod Stock Code	
21-Kalıplı/Molding	129	25	0,300	304 021 102	6
		30		304 021 202	
		35		304 021 302	
		40		304 021 402	
23-Kalıplı/Molding	141	25	0,325	304 023 102	6
		30		304 023 202	
		35		304 023 302	
		40		304 023 402	
25-Kalıplı/Molding	153	25	0,385	304 025 102	6
		30		304 025 202	
		35		304 025 302	
		40		304 025 402	

*Özel üretim yapılır./On request special production is available.

312 TEK PARÇALI DÜZGÜN DOĞRUSAL PASLANMAZ BANT AVARE DİŞLİSİ/IDLER SPROCKETS

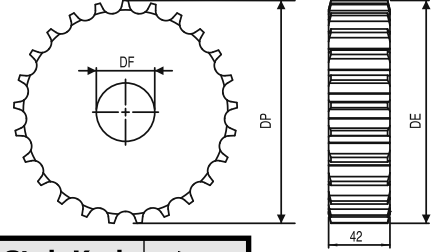
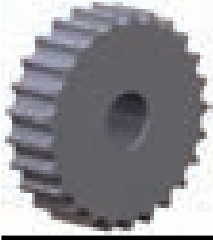
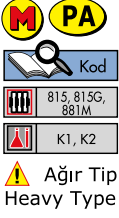

Z-İmalat Şekil Manufacture	DE	DP	DF	Kg	Stok Kod Stock Code	
17-Talaşlı/Sawdust	104	105,47	25	0,20	312 TI1 117	8
			30		312 TI1 217	
19-Talaşlı/Sawdust	117	117,34	25	0,30	312 TI1 119	
			30		312 TI1 219	
21-Talaşlı/Sawdust	129	129,26	25	0,40	312 TI1 121	
			30		312 TI1 221	
			35		312 TI1 321	
23-Talaşlı/Sawdust	141	141,22	25	0,50	312 TI1 123	
			30		312 TI1 223	
			35		312 TI1 323	
25-Talaşlı/Sawdust	153	153,20	25	0,60	312 TI1 125	
			30		312 TI1 225	
			35		312 TI1 325	
			40		312 TI1 425	

314 İKİ PARÇALI PASLANMAZ BANT DİŞLİSİ(GÜÇLENDİRİLMİŞ POLYAMİD)/SPLIT SPROCKETS(REINFORCED POLYAMIDE)

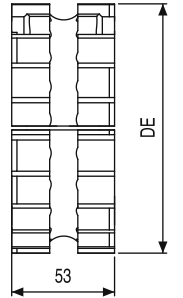
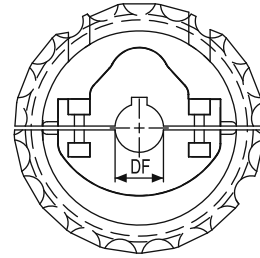
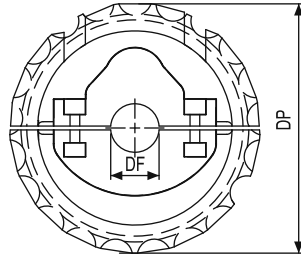

Z-İmalat Şekil Manufacture	DE	DP	DF	Kg	Stok Kod/Stock Code		
					T	A	
21-Kalıplı-Molding	129	129,26	25	0,44	314 KI2 121	314 KI2 121A	8
			30		314 KI2 221	314 KI2 221A	
			35		314 KI2 321	314 KI2 321A	
			40		314 KI2 421	314 KI2 421A	
23-Kalıplı-Molding	141	141,22	25	0,50	314 KI2 123	314 KI2 123A	
			30		314 KI2 223	314 KI2 223A	
			35		314 KI2 323	314 KI2 323A	
25-Kalıplı-Molding	153	153,20	25	0,60	314 KI2 125	314 KI2 125A	
			30		314 KI2 225	314 KI2 225A	
			35		314 KI2 325	314 KI2 325A	
			40		314 KI2 425	314 KI2 425A	

*Özel üretim yapılır./On request special production is available.

350 İKİ PARÇALI DÜZGÜN DOĞRUSAL PASLANMAZ BANT TAHRİK DİŞLİSİ/SPLIT SPROCKETS

M Döküm Polyamid/Cast Polyamide

Kod

815, 815G,
881M

K1, K2



Ağır Tip
Heavy Type

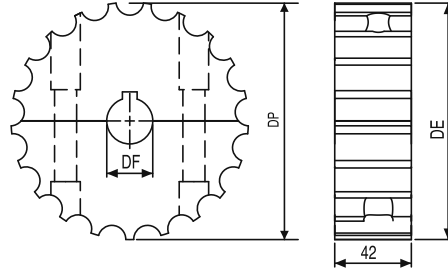

Z-İmalat Şekil Manufacture	DE	DP	DF	Kg	Stok Kod Stock Code	
21-Talaşlı/Sawdust	129	129,26	25	0,40	350 TI2 121	8
			30		350 TI2 221	
			35		350 TI2 321	
21-Talaşlı/Sawdust	129	129,26	25	0,40	350 ATT 121*	
			30		350 ATT 221*	
			35		350 ATT 321*	
23-Talaşlı/Sawdust	141	141,22	25	0,50	350 TI2 123	
			30		350 TI2 223	
			35		350 TI2 323	
23-Talaşlı/Sawdust	141	141,22	25	0,50	350 ATT 123*	
			30		350 ATT 223*	
			35		350 ATT 323*	
25-Talaşlı/Sawdust	153	153,20	25	0,60	350 TI2 125	
			30		350 TI2 225	
			35		350 TI2 325	
25-Talaşlı/Sawdust	153	153,20	25	0,60	350 ATT 125*	
			30		350 ATT 225*	
			35		350 ATT 325*	
			40		350 ATT 425*	

(*) Asidik ortam için/Acid resistance (Polipropilen/Polypropylene-ALPOLEN®1000)
ALPOLEN®1000 siparişleriniz için (*) bulunan stok kodunun sonuna (A) ekleyiniz.
For ALPOLEN®1000 request, please add to (A) end of the stock code (*)

374 SİLİNDİR KULAKLI YARASA BANT DİŞLİLERİ (TEK PARÇA)/DRIVE SPROCKETS FOR FLEX CHAINS

M Döküm Polyamid/Cast Polyamide

Kod

881

K1, K2

Ağır Tip
Heavy Type

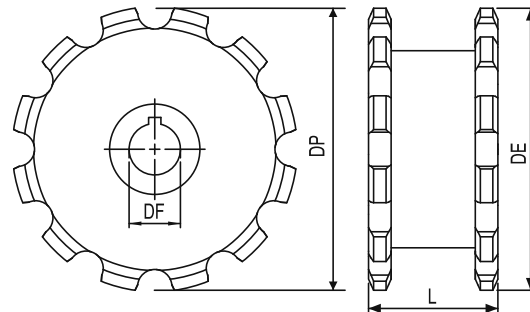

Z-İmalat Şekil Manufacture	DE	DP	DF	L	Stok Kod Stock Code	
12-Talaşlı/Sawdust	138,50	116	25	53	374 KDS 082	8
12-Talaşlı/Sawdust	148	122	25	72	374 KDS 114	6

*Özel üretim yapılır./On request special production is available.

320 TEK PARÇALI PLASTİK BANT DİŞLİSİ/DRIVE SPROCKETS

M Döküm Polyamid/Cast Polyamide

Kod

820

K1, K2

Ağır Tip
Heavy Type

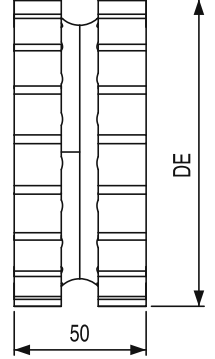
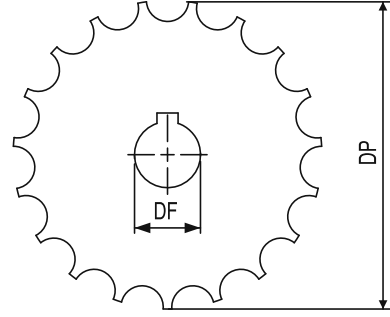

Z-İmalat Şekil Manufacture	DE	DP	DF	Kg	Stok Kod Stock Code	
17-Talaşlı/Sawdust	104	104,50	25	0,30	320 TI1 117	8
			30		320 TI1 217	
19-Talaşlı/Sawdust	117	117,34	25	0,35	320 TI1 119	
			30		320 TI1 219	
21-Talaşlı/Sawdust	129	129,26	25	0,45	320 TI1 121	
			30		320 TI1 221	
23-Talaşlı/Sawdust	141	141,22	25	0,50	320 TI1 123	
			30		320 TI1 223	
25-Talaşlı/Sawdust	153	153,20	25	0,60	320 TI1 125	
			30		320 TI1 225	

312 PLASTİK BANT TAHRİK DİŞLİSİ (POLYAMİD PA6 KATKILI)/IDLER SPROCKETS

M Güçlendirilmiş Polyamid/Reinforced Polyamide

Kod

820

K1, K2

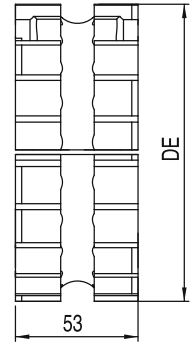
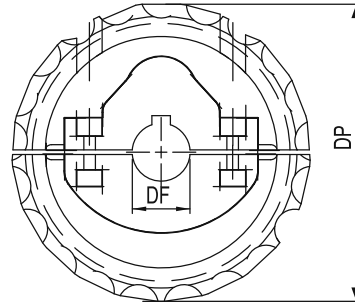

Z-İmalat Şekil Manufacture	DE	DP	DF	Kg	Stok Kod Stock Code	
21-Kalıplı-Molding	129	129,26	25	0,40	312 KI2 121	8
			30		312 KI2 221	
			35		312 KI2 321	
			40		312 KI2 421	
23-Kalıplı-Molding	141	141,22	25	0,50	312 KI2 123	
			30		312 KI2 223	
			35		312 KI2 323	
			40		312 KI2 423	
25-Kalıplı-Molding	153	153,20	25	0,60	312 KI2 125	
			30		312 KI2 225	
			35		312 KI2 325	
			40		312 KI2 425	

*Özel üretim yapılır./On request special production is available.

340 TEK PARÇALI AVARA BANT DİŞLİSİ/IDLER SPROCKETS

M Döküm Polyamid/Cast Polyamide

- Kod
- 820
- K1, K2
- Ağır Tip Heavy Type

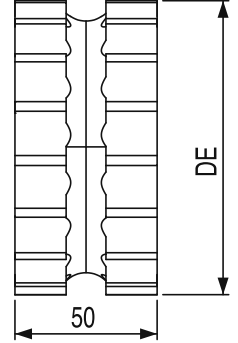
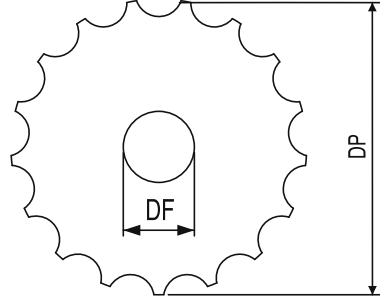

Z-İmalat Şekil Manufacture	DE	DP	DF	Kg	Stok Kod Stock Code	
17-Talaşlı/Sawdust	104	104,50	25	0,30	340 TI1 117	8
			30		340 TI1 217	
19-Talaşlı/Sawdust	117	117,34	25	0,35	340 TI1 119	
			30		340 TI1 219	
21-Talaşlı/Sawdust	129	129,26	25	0,45	340 TI1 121	
			30		340 TI1 221	
23-Talaşlı/Sawdust	141	141,22	25	0,50	340 TI1 123	
			30		340 TI1 223	
25-Talaşlı/Sawdust	153	153,20	25	0,60	340 TI1 125	
			30		340 TI1 225	

311 PLASTİK BANT AVARA DİŞLİSİ (POLYAMİD PA6 KATKILI)/IDLER SPROCKETS

M Güçlendirilmiş Polyamid/Reinforced Polyamide

- Kod
- 820
- K1, K2
-

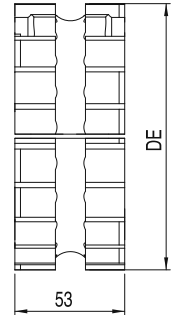
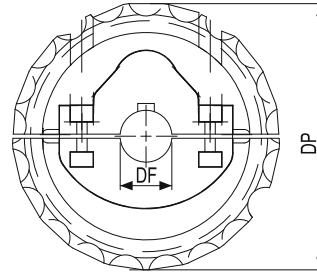

Z-İmalat Şekil Manufacture	DE	DP	DF	Kg	Stok Kod Stock Code	
21-Kalıplı-Molding	129	129,26	25	0,40	311 KI2 121	8
			30		311 KI2 221	
			35		311 KI2 321	
			40		311 KI2 421	
23-Kalıplı-Molding	141	141,22	25	0,50	311 KI2 123	
			30		311 KI2 223	
			35		311 KI2 323	
			40		311 KI2 423	
25-Kalıplı-Molding	153	153,20	25	0,60	311 KI2 125	
			30		311 KI2 225	
			35		311 KI2 325	
			40		311 KI2 425	

*Özel üretim yapılır./On request special production is available.

320 İKİ PARÇALI PLASTİK BANT DİŞLİSİ/DRIVE SPROCKETS

M Döküm Polyamid/Cast Polyamide

Kod

820

K1, K2



Ağır Tip
Heavy Type

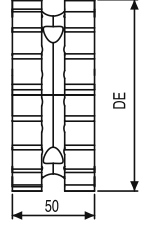
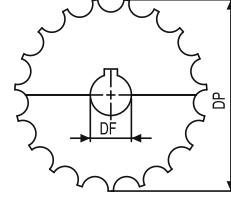

Z-İmalat Şekil Manufacture	DE	DP	DF	Kg	Stok Kod Stock Code	
19-Talaşlı/Sawdust	117	117,34	25	0,30	320 TI2 119	15
			30		320 TI2 219	
			25		320 AI2 119*	
			30		320 AI2 219*	
21-Talaşlı/Sawdust	129	129,26	25	0,40	320 TI2 121	10
			30		320 TI2 221	
			35		320 TI2 321	
			40		320 TI2 421	
21-Talaşlı/Sawdust	129	129,26	25	0,40	320 AI2 121*	8
			30		320 AI2 221*	
			35		320 AI2 321*	
			40		320 AI2 421*	
23-Talaşlı/Sawdust	141	141,22	25	0,50	320 TI2 123	8
			30		320 TI2 223	
			35		320 TI2 323	
			40		320 TI2 323	
23-Talaşlı/Sawdust	141	141,22	25	0,50	320 AI2 123*	8
			30		320 AI2 223*	
			35		320 AI2 323*	
			40		320 AI2 423*	
25-Talaşlı/Sawdust	153	153,20	25	0,60	320 TI2 125	8
			30		320 TI2 225	
			35		320 TI2 325	
			40		320 TI2 425	
25-Talaşlı/Sawdust	153	153,20	25	0,60	320 AI2 125*	8
			30		320 AI2 225*	
			35		320 AI2 325*	
			40		320 AI2 425*	

(*) Asidik ortam için/Acid resistance (Polipropilen/Polypropylene-ALPOLEN®1000)
ALPOLEN®1000 siparişleriniz için (*) bulunan stok kodunun sonuna (A) ekleyiniz.
For ALPOLEN®1000 request, please add to (A) end of the stock code (*)

328 PLASTİK TEK PARÇA BANT TAHRİK DİŞLİSİ (POLYAMİD PA6 KATKILI)/DRIVE SPROCKETS

M Güçlendirilmiş Polyamid/Reinforced Polyamide

Kod

820

K1, K2

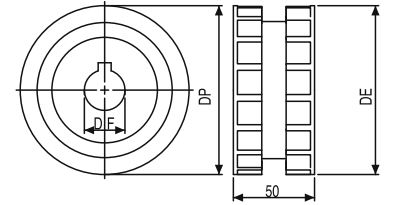

Z-İmalat Şekil Manufacture	DE	DP	DF	Kg	Stok Kod Stock Code	
17-Kalıplı-Molding	104	104,50	25	0,28	328 KI1 117	20
			30		328 KI1 217	
19-Kalıplı-Molding	117	117,34	25	0,30	328 KI1 119	15
			30		328 KI1 219	
21-Kalıplı-Molding	129	129,26	25	0,40	328 KI1 121	10
			30		328 KI1 221	
23-Kalıplı-Molding	141	141,22	25	0,50	328 KI1 123	8
			30		328 KI1 223	

*Özel üretim yapılır./On request special production is available.



325 ÇİFT MENTEŞELİ ASETAL VE PASLANMAZ BANT TEK PARÇA/DRIVE SPROCKETS

M Güçlendirilmiş Polyamid/Reinforced Polyamide

Kod	805, 821 821 BPM
	K1, K2

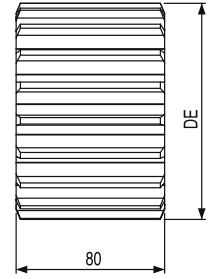
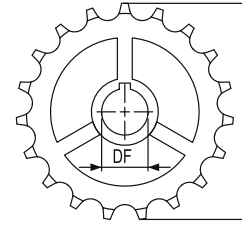
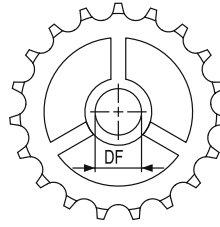

A : AVARA DİŞLİSİ

T : TAHRİK DİŞLİSİ

Z-İmalat Şekil Manufacture	DE	DP	DF	Kg	Stok Kod/Stock Code		4
					T	A	
19-Kalıplı/Molding	117	117,34	25	0,50	325 CMK 119	325 CMK 119A	4
			30		325 CMK 219	325 CMK 219A	
			35		325 CMK 319	325 CMK 319A	
			40		325 CMK 419	325 CMK 419A	
21-Kalıplı/Molding	129	129,26	25	0,60	325 CMK 121	325 CMK 121A	
			30		325 CMK 221	325 CMK 221A	
			35		325 CMK 321	325 CMK 321A	
			40		325 CMK 421	325 CMK 421A	
23-Kalıplı/Molding	141	141,22	25	0,70	325 CMK 123	325 CMK 123A	
			30		325 CMK 223	325 CMK 223A	
			35		325 CMK 323	325 CMK 323A	
			40		325 CMK 423	325 CMK 423A	
25-Kalıplı/Molding	153	153,20	25	0,90	325 CMK 125	325 CMK 125A	
			30		325 CMK 225	325 CMK 225A	
			35		325 CMK 325	325 CMK 325A	
			40		325 CMK 425	325 CMK 425A	

MODEL: 383-385 HAFİF-AĞIR TİP TEK PARÇA TAHRİK-AVARA DİŞLİSİ/LIGHT-HEAVY DRIVING & IDLER SPROCKET

M Polyamid/Reinforced Polyamide **PA**
Polipropilen/Polypropylene **PP**

Kod	880, 880M, 880TAB, 882TAB



385 H25 A..

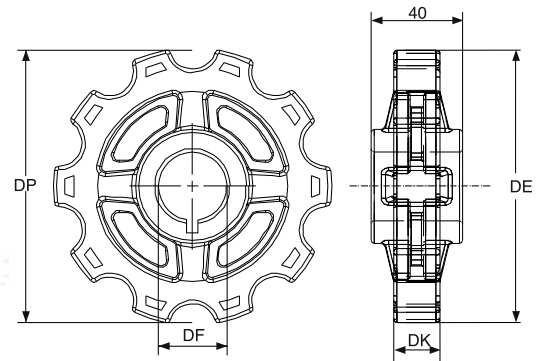

385 H25 T..

Z	DF	DE	DP	DK	Kg	Stok Kod Stock Code	4	
880	*10	25	122	122,30	15	0,126	385 H25 T10	4
	*10	30	122	122,30	15	0,132	385 H30 A10	
	12	25	147	146,80	15	0,157	385 H25 T12	
	12	30	147	146,80	15	0,164	385 H30 A12	
882	*10	25	122	122,30	20	0,134	383 A25 T10	
	*10	30	122	122,30	20	0,140	383 A30 A10	
	12	25	147	146,80	20	0,186	383 A25 T12	
	12	30	147	146,80	20	0,193	383 A30 A12	

*Özel üretim yapılır./On request special production is available.

395 ÇİFT MENTEŞE ASETAL VE PASLANMAZ BANT DİŞLİSİ(İKİ PARÇALI)/SPLIT SPROCKETS

M Döküm Polyamid/Cast Polyamide

Kod

805, 821,
821 BFM

K1, K2

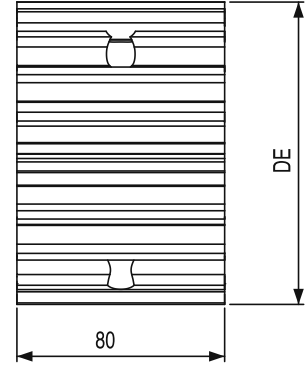
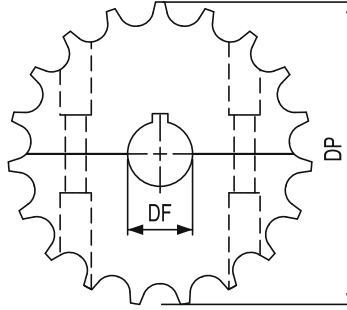
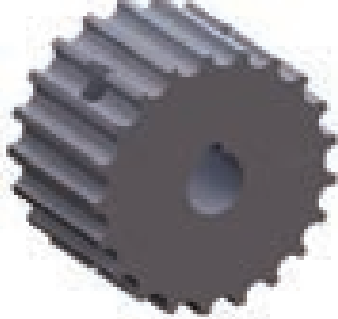

Z-İmalat Şekil Manufacture	DE	DP	DF	Kg	Stok Kod Stock Code	
19-Talaşlı/Sawdust	117	117,34	25	0,70	395 CM2 119	4
			30		395 CM2 219	
			35		395 CM2 319	
			40		395 CM2 419	
19-Talaşlı/Sawdust	117	117,34	25	0,70	395 CMA 119*	4
			30		395 CMA 219*	
			35		395 CMA 319*	
			40		395 CMA 419*	
21-Talaşlı/Sawdust	129	129,26	25	0,80	395 CM2 121	4
			30		395 CM2 221	
			35		395 CM2 321	
			40		395 CM2 421	
21-Talaşlı/Sawdust	129	129,26	25	0,80	395 CMA 121*	4
			30		395 CMA 221*	
			35		395 CMA 321*	
			40		395 CMA 421*	
23-Talaşlı/Sawdust	141	141,22	25	1,10	395 CM2 123	4
			30		395 CM2 223	
			35		395 CM2 323	
			40		395 CM2 423	
23-Talaşlı/Sawdust	141	141,22	25	1,10	395 CMA 123*	4
			30		395 CMA 223*	
			35		395 CMA 323*	
			40		395 CMA 423*	
25-Talaşlı/Sawdust	153	153,20	25	1,20	395 CM2 125	4
			30		395 CM2 225	
			35		395 CM2 325	
			40		395 CM2 425	
25-Talaşlı/Sawdust	153	153,20	25	1,20	395 CMA 125*	4
			30		395 CMA 225*	
			35		395 CMA 325*	
			40		395 CMA 425*	

(* Asidik ortam için/Acid resistance (Polipropilen/Polypropylene-ALPOLEN®1000)
ALPOLEN®1000 siparişleriniz için (*) bulunan stok kodunun sonuna (A) ekleyiniz.
For ALPOLEN®1000 request, please add to (A) end of the stock code (*)

*Özel üretim yapılır./On request special production is available.

386 ASETAL DÖNÜŞLÜ BANT DIŞLİLERİ (İKİ PARÇA)/SPLIT SPROCKETS

M Döküm Polyamid/Cast Polyamide

Kod

880, 880 TAB

K1, K2

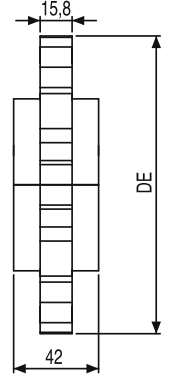
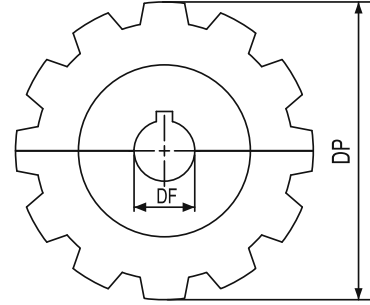

Z-İmalat Şekil Manufacture	DE	DP	DF	Kg	Stok Kod Stock Code	
9-Talaşlı/Sawdust	110	111,4	25	0,20	386 KDT 109	8
			30		386 KDT 209	
			35		386 KDT 309	
			40		386 KDT 409	
9-Talaşlı/Sawdust	110	111,4	25	0,20	386 KDA 109*	
			30		386 KDA 209*	
			35		386 KDA 309*	
			40		386 KDA 409*	
10-Talaşlı/Sawdust	122	122,3	25	0,30	386 KDT 110	
			30		386 KDT 210	
			35		386 KDT 310	
			40		386 KDT 410	
10-Talaşlı/Sawdust	122	122,3	25	0,30	386 KDA 110*	
			30		386 KDA 210*	
			35		386 KDA 310*	
			40		386 KDA 410*	
11-Talaşlı/Sawdust	135	135,2	25	0,30	386 KDT 111	
			30		386 KDT 211	
			35		386 KDT 311	
			40		386 KDT 411	
11-Talaşlı/Sawdust	135	135,2	25	0,30	386 KDA 111*	
			30		386 KDA 211*	
			35		386 KDA 311*	
			40		386 KDA 411*	
12-Talaşlı/Sawdust	147,3	147,2	25	0,40	386 KDT 112	
			30		386 KDT 212	
			35		386 KDT 312	
			40		386 KDT 412	
12-Talaşlı/Sawdust	147,3	147,2	25	0,40	386 KDA 112*	
			30		386 KDA 212*	
			35		386 KDA 312*	
			40		386 KDA 412*	

(*) Asidik ortam için/Acid resistance (Polipropilen/Polypropylene-ALPOLEN®1000)
ALPOLEN®1000 siparişleriniz için (*) bulunan stok kodunun sonuna (A) ekleyiniz.
For ALPOLEN®1000 request, please add to (A) end of the stock code (*)

*Özel üretim yapılır./On request special production is available.

387 ASETAL DÖNÜŞLÜ BANT DİŞLİLERİ (TEK PARÇA)/DRIVE SPROCKETS

M Döküm Polyamid/Cast Polyamide

Kod

880, 880 TAB

K1, K2

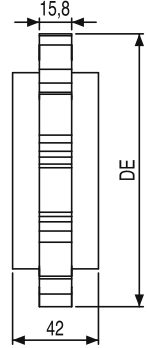
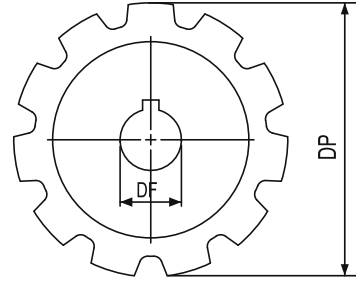

Z-İmalat Şekil Manufacture	DE	DP	DF	Kg	Stok Kod Stock Code	
9-Talaşlı/Sawdust	110	111,4	25	0,20	387 KDT 109	10
			30		387 KDT 209	
			35		387 KDT 309	
			40		387 KDT 409	
9-Talaşlı/Sawdust	110	111,4	25	0,20	387 KDA 109*	
			30		387 KDA 209*	
			35		387 KDA 309*	
			40		387 KDA 409*	
10-Talaşlı/Sawdust	122	122,3	25	0,30	387 KDT 110	
			30		387 KDT 210	
			35		387 KDT 310	
			40		387 KDT 410	
10-Talaşlı/Sawdust	122	122,3	25	0,30	387 KDA 110*	
			30		387 KDA 210*	
			35		387 KDA 310*	
			40		387 KDA 410*	
11-Talaşlı/Sawdust	135	135,2	25	0,30	387 KDT 111	
			30		387 KDT 211	
			35		387 KDT 311	
			40		387 KDT 411	
11-Talaşlı/Sawdust	135	135,2	25	0,30	387 KDA 111*	
			30		387 KDA 211*	
			35		387 KDA 311*	
			40		387 KDA 411*	
12-Talaşlı/Sawdust	147,3	147,2	25	0,40	387 KDT 112	
			30		387 KDT 212	
			35		387 KDT 312	
			40		387 KDT 412	
12-Talaşlı/Sawdust	147,3	147,2	25	0,40	387 KDA 112*	
			30		387 KDA 212*	
			35		387 KDA 312*	
			40		387 KDA 412*	

(* Asidik ortam için/Acid resistance (Polipropilen/Polypropylene-ALPOLEN®1000) ALPOLEN®1000 siparişleriniz için (*) bulunan stok kodunun sonuna (A) ekleyiniz. For ALPOLEN®1000 request, please add to (A) end of the stock code (*)

*Özel üretim yapılır./On request special production is available.



371 TAB KULAKLI DÖNÜŞLÜ PASLANMAZ BANT DİŞLİLERİ (İKİ PARÇA)/SPLIT SPROCKETS

M Döküm Polyamid/Cast Polyamide

Kod

881, 881 TAB

K1, K2

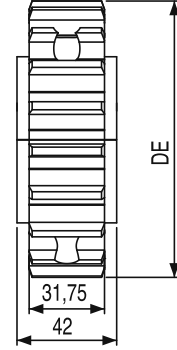
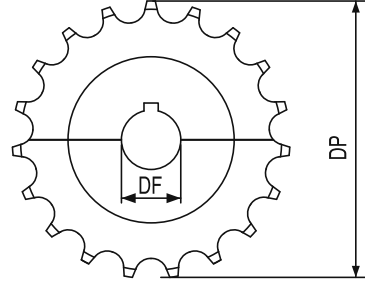

Z-İmalat Şekil Manufacture	DE	DP	DF	Kg	Stok Kod Stock Code	
19-Talaşlı/Sawdust	117	117,34	25	0,70	371 KDT 119	10
			30		371 KDT 219	
			35		371 KDT 319	
			40		371 KDT 419	
19-Talaşlı/Sawdust	117	117,34	25	0,70	371 KDA 119*	
			30		371 KDA 219*	
			35		371 KDA 319*	
			40		371 KDA 419*	
21-Talaşlı/Sawdust	129	129,26	25	0,80	371 KDT 121	
			30		371 KDT 221	
			35		371 KDT 321	
			40		371 KDT 421	
21-Talaşlı/Sawdust	129	129,26	25	0,80	371 KDA 121*	
			30		371 KDA 221*	
			35		371 KDA 321*	
			40		371 KDA 421*	
23-Talaşlı/Sawdust	141	141,22	25	1,10	371 KDT 123	
			30		371 KDT 223	
			35		371 KDT 323	
			40		371 KDT 423	
23-Talaşlı/Sawdust	141	141,22	25	1,10	371 KDA 123*	
			30		371 KDA 223*	
			35		371 KDA 323*	
			40		371 KDA 423*	
25-Talaşlı/Sawdust	153	153,20	25	1,20	371 KDT 125	
			30		371 KDT 225	
			35		371 KDT 325	
			40		371 KDT 425	
25-Talaşlı/Sawdust	153	153,20	25	1,20	371 KDA 125*	
			30		371 KDA 225*	
			35		371 KDA 325*	
			40		371 KDA 425*	

(* Asidik ortam için/Acid resistance (Polipropilen/Polypropylene-ALPOLEN®1000)
ALPOLEN®1000 siparişleriniz için (*) bulunan stok kodunun sonuna (A) ekleyiniz.
For ALPOLEN®1000 request, please add to (A) end of the stock code (*)

*Özel üretim yapılır./On request special production is available.

382 TAB KULAKLI DÖNÜŞLÜ PASLANMAZ BANT TAHRİK DİŞLİLERİ (TEK PARÇA)/SPLIT SPROCKETS

M Döküm Polyamid/Cast Polyamide

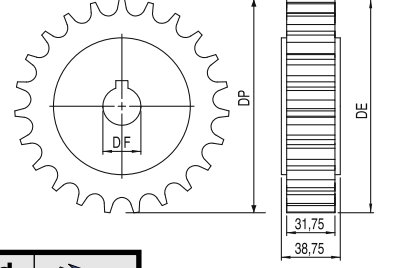
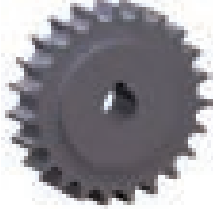

Z-İmalat Şekil Manufacture	DE	DP	DF	Kg	Stok Kod Stock Code	
19-Talaşlı/Sawdust	117	117,34	25	0,30	382 KDT 119	10
			30		382 KDT 219	
			35		382 KDT 319	
			40		382 KDT 419	
21-Talaşlı/Sawdust	129	129,26	25	0,40	382 KDT 121	
			30		382 KDT 223	
			35		382 KDT 323	
			40		382 KDT 423	
23-Talaşlı/Sawdust	141	141,22	25	0,50	382 KDT 123	
			30		382 KDT 223	
			35		382 KDT 323	
			40		382 KDT 423	
25-Talaşlı/Sawdust	153	153,20	25	0,60	382 KDT 125	
			30		382 KDT 225	
			35		382 KDT 325	
			40		382 KDT 425	

392 AĞIR TİP ASETAL DÖNÜŞLÜ BANT DİŞLİ (TEK PARÇA)/DRIVE SPROCKETS

M Döküm Polyamid/Cast Polyamide

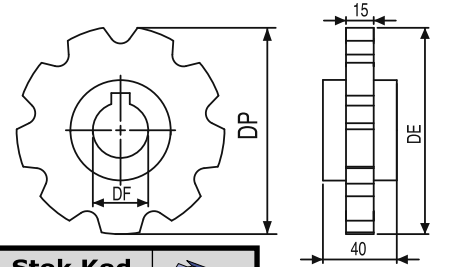

Z-İmalat Şekil Manufacture	DE	DP	DF	Kg	Stok Kod Stock Code	
9-Talaşlı-Sawdust	110	114,4	25	0,20	392 KDT 109	10
			30		392 KDT 209	
			35		392 KDT 309	
			40		392 KDT 409	
10-Talaşlı-Sawdust	122	123,3	25	0,26	392 KDT 110	
			30		392 KDT 210	
			35		392 KDT 310	
			40		392 KDT 410	
11-Talaşlı-Sawdust	135	135,2	25	0,33	392 KDT 111	
			30		392 KDT 211	
			35		392 KDT 311	
			40		392 KDT 411	
12-Talaşlı-Sawdust	147	147,2	25	0,41	392 KDT 112	
			30		392 KDT 212	
			35		392 KDT 312	
			40		392 KDT 412	

*Özel üretim yapılır./On request special production is available.

326 HASIR BANT DİŞLİSİ (İKİ PARÇALI PA6 POLYAMİD)/SPLIT SPROCKETS

M Polyamid/Polyamide

Kod

830, 832
833, 855

K1, K2

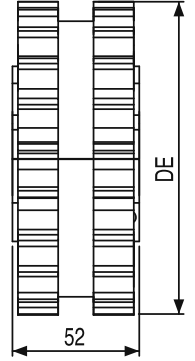
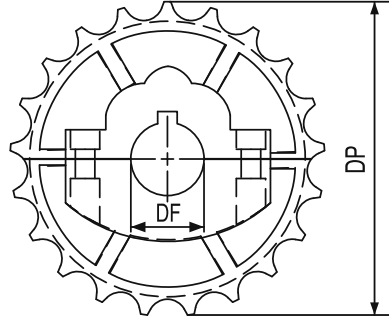

Z-İmalat Şekil Manufacture	DE	DP	DF	Kg	Stok Kod Stock Code	
21-Kalıplı/Molding	129	129,26	25	0,46	326 KI2 121	8
			30		326 KI2 221	
			35		326 KI2 321	
			40		326 KI2 421	
23-Kalıplı/Molding	142	141,22	25	0,54	326 KI2 123	
			30		326 KI2 223	
			35		326 KI2 323	
			40		326 KI2 423	
25-Kalıplı/Molding	153	153,20	25	0,63	326 KI2 125	
			30		326 KI2 225	
			35		326 KI2 325	
			40		326 KI2 425	

329 HASIR BANT DİŞLİSİ (TEK PARÇA POLYAMİD PA6 KATKILI)/DRIVE SPROCKETS

M Polyamid/Polyamide

Kod

830, 832
833, 855

K1, K2

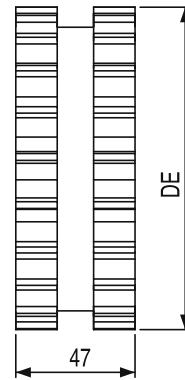
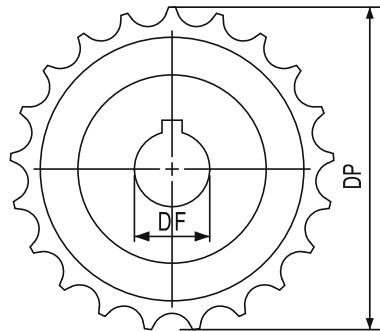

Z-İmalat Şekil Manufacture	DE	DP	DF	Kg	Stok Kod Stock Code	
17-Kalıplı/Molding	105	105,40	25	0,28	329 KI1 117	20
			30		329 KI1 217	20
19-Kalıplı/Molding	117	117,34	25		329 KI1 119	15
			30		329 KI1 219	15

*Özel üretim yapılır./On request special production is available.

315 ÇİFT MENTEŞE ASETAL VE PASLANMAZ TEK PARÇA BANT DİŞLİSİ/IDLER SPROCKETS

M Döküm Polyamid/Cast Polyamide

Kod

805, 821
821 BPM

K1, K2

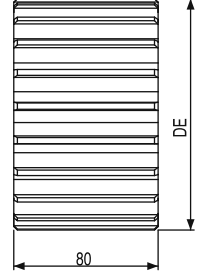
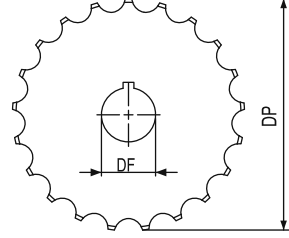
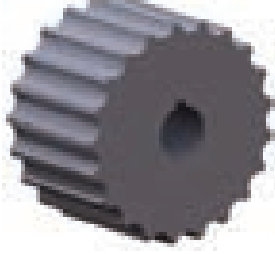

Z-İmalat Şekil Manufacture	DE	DP	DF	Kg	Stok Kod Stock Code	
19-Talaşlı/Sawdust	117	117,34	25	0,70	315 CMT 119	8
			30		315 CMT 219	
			35		315 CMT 319	
			40		315 CMT 419	
21-Talaşlı/Sawdust	129	129,26	25	0,80	315 CMT 121	
			30		315 CMT 221	
			35		315 CMT 321	
			40		315 CMT 421	
23-Talaşlı/Sawdust	141	141,20	25	1,10	315 CMT 123	
			30		315 CMT 223	
			35		315 CMT 323	
			40		315 CMT 423	
25-Talaşlı/Sawdust	153	153,20	25	1,20	315 CMT 125	
			30		315 CMT 225	
			35		315 CMT 325	
			40		315 CMT 425	

310 KASA TAŞIMA BANT DİŞLİSİ/SPLIT SPROCKETS

M Döküm Polyamid/Cast Polyamide

Kod

855, 856

K1, K2

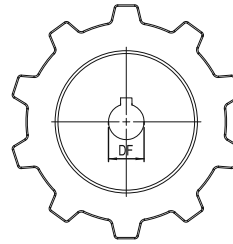
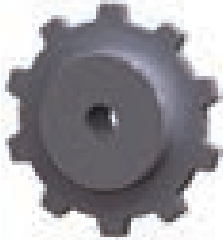

T: Tahrik Dişlisi
Drive Sprockets

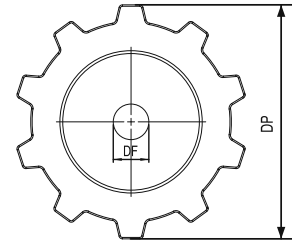

A: Avara Kasnak
Idler Sprockets

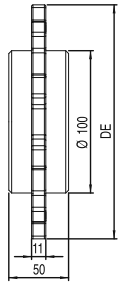

Z-İmalat Şekil Manufacture	DE	DP	DF	Kg	Stok Kod Stock Code	
8 Talaşlı/Sawdust	167	139	25	0,6	310 T25 008	10
			30		310 T30 008	
			25		310 A25 008	
			30		310 A30 008	
10 Talaşlı/Sawdust	207	176	25	0,8	310 T25 010	
			30		310 T30 010	
			25		310 A25 010	
			30		310 A30 010	
12 Talaşlı/Sawdust	248	220	25	1,1	310 T25 012	
			30		310 T30 012	
			25		310 A25 012	
			30		310 A30 012	

*Özel üretim yapılır./On request special production is available.

360 HASIR BANT TEK PARÇA BANT DİŞLİSİ/DRIVE SPROCKETS

M Döküm Polyamid/Cast Polyamide



830, 832
833, 855

K1, K2

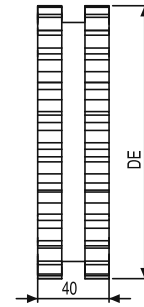
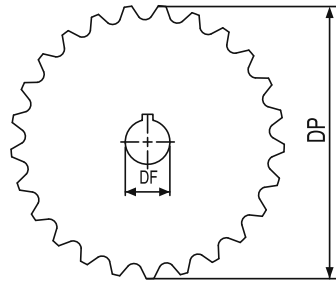

Z-İmalat Şekil Manufacture	DE	DP	DF	Kg	Stok Kod Stock Code	
17-Talaşlı/Sawdust	105	105,44	20	0,30	360 TIO 017	20
			25		360 TIO 117	
			30		360 TIO 217	
			35		360 TIO 317	
			40		360 TIO 417	
17-Talaşlı/Sawdust	105	105,44	20	0,30	360 TIA 017*	
			25		360 TIA 117*	
			30		360 TIA 217*	
			35		360 TIA 317*	
			40		360 TIA 417*	
19-Talaşlı/Sawdust	115	115,65	25	0,38	360 TIO 119	15
			30		360 TIO 219	
			35		360 TIO 319	
			40		360 TIO 419	
19-Talaşlı/Sawdust	115	115,65	25	0,38	360 TIA 119*	
			30		360 TIA 219*	
			35		360 TIA 319*	
			40		360 TIA 419*	
21-Talaşlı/Sawdust	129	129,26	25	0,46	360 TIO 121	10
			30		360 TIO 221	
			35		360 TIO 321	
			40		360 TIO 421	
21-Talaşlı/Sawdust	129	129,26	25	0,46	360 TIA 121*	
			30		360 TIA 221*	
			35		360 TIA 321*	
			40		360 TIA 421*	
23-Talaşlı/Sawdust	141	141,22	25	0,54	360 TIO 123	8
			30		360 TIO 223	
			35		360 TIO 323	
			40		360 TIO 423	
23-Talaşlı/Sawdust	141	141,22	25	0,54	360 TIA 123*	
			30		360 TIA 223*	
			35		360 TIA 323*	
			40		360 TIA 423*	
25-Talaşlı/Sawdust	153	153,20	25	0,63	360 TIO 125	
			30		360 TIO 225	
			35		360 TIO 325	
			40		360 TIO 425	
25-Talaşlı/Sawdust	153	153,20	25	0,63	360 TIA 125*	
			30		360 TIA 225*	
			35		360 TIA 325*	
			40		360 TIA 425*	

(*) Asidik ortam için/Acid resistance (Polipropilen/Polypropylene-ALPOLEN®1000)
ALPOLEN®1000 siparişleriniz için (*) bulunan stok kodunun sonuna (A) ekleyiniz.
For ALPOLEN®1000 request, please add to (A) end of the stock code (*)

*Özel üretim yapılır./On request special production is available.

318 KARDENİK BANT AVARA DİŞLİSİ/DRIVE SPROCKETS

M Güçlendirilmiş Polyamid/Reinforced Polyamide

Kod
860, 865, 867 870, 875
K1, K2

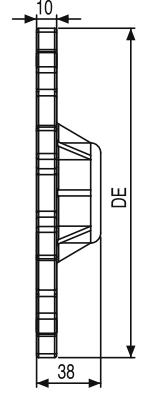
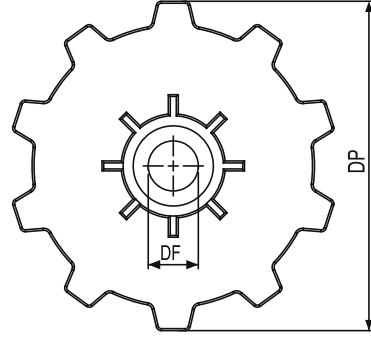

Z-İmalat Şekil Manufacture	DE	DP	DF	Kg	Stok Kod Stock Code	
10 Kalıplı- Molding	165	159	25	0,36	318 T25 010	10
10 Kalıplı- Molding	165	159	30	0,40	318 T30 010	10

338 KARDENİK BANT TAHRİK DİŞLİSİ/SPLIT SPROCKETS

M Güçlendirilmiş Polyamid/Reinforced Polyamide

Kod
860, 865, 867 870, 875
K1, K2

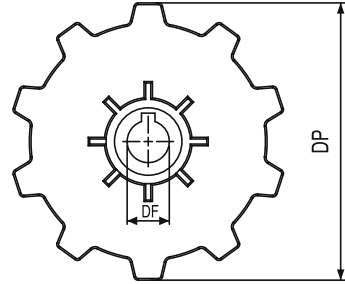

Z-İmalat Şekil Manufacture	DE	DP	DF	Kg	Stok Kod Stock Code	
10 Kalıplı- Molding	165	159	25	0,36	338 T25 010	10
10 Kalıplı- Molding	165	159	30	0,40	338 T30 010	10

310 METAL DİŞLİ/SPLIT SPROCKETS

M St37 * **SS**

Kod
815, 815 G, 881M
K1, K2

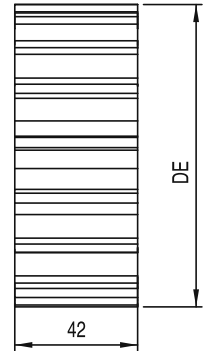
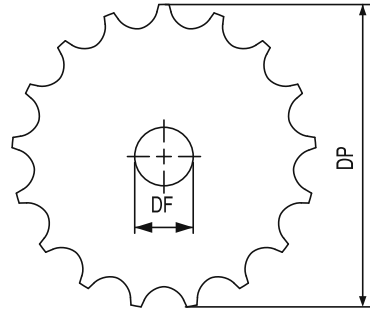

Z-İmalat Şekil Manufacture	DE	DP	DF	Kg	Stok Kod Stock Code	
17 Talaşlı - Sawdust	104	105,40	20	2,40	310 KI1 M17	4
19 Talaşlı - Sawdust	117	117,34	20	3,10	310 KI1 M19	
21 Talaşlı - Sawdust	129	129,26	20	3,90	310 KI1 M21	
23 Talaşlı - Sawdust	141	141,22	20	4,60	310 KI1 M23	
25 Talaşlı - Sawdust	153	153,20	20	5,50	310 KI1 M25	

*Özel üretim yapılır./On request special production is available.

380 PASLANMAZ DÖNÜŞLÜ BANT TAHRİK DİŞLİSİ/SPLIT SPROCKETS

M Kalıplı Güçlendirilmiş Polyamid/Reinforced Polyamide

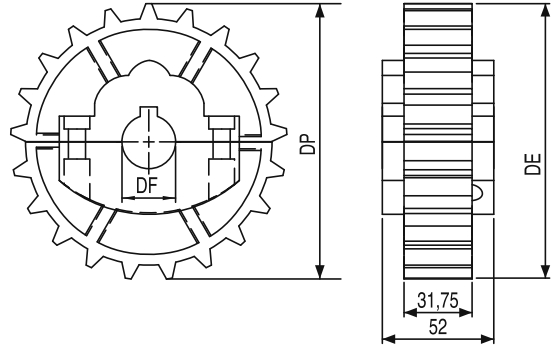

Z-İmalat Şekil Manufacture	DE	DP	DF	Kg	Stok Kod Stock Code	
21- Kalıplı - Molding	129	129,26	25	0,40	380 825 021	8
21- Kalıplı - Molding	129	129,26	30	0,40	380 830 021	
21- Kalıplı - Molding	129	129,26	35	0,40	380 835 021	
21- Kalıplı - Molding	129	129,26	40	0,40	380 840 021	
21- Kalıplı - Molding	129	129,26	45	0,40	380 845 021	
23- Kalıplı - Molding	141	141,22	25	0,46	380 825 023	
23- Kalıplı - Molding	141	141,22	30	0,46	380 830 023	
23- Kalıplı - Molding	141	141,22	35	0,46	380 835 023	
23- Kalıplı - Molding	141	141,22	40	0,46	380 840 023	
23- Kalıplı - Molding	141	141,22	45	0,46	380 845 023	
25- Kalıplı - Molding	153	153,20	25	0,64	380 825 025	
25- Kalıplı - Molding	153	153,20	30	0,64	380 830 025	
25- Kalıplı - Molding	153	153,20	35	0,64	380 835 025	
25- Kalıplı - Molding	153	153,20	40	0,64	380 840 025	
25- Kalıplı - Molding	153	153,20	45	0,64	380 845 025	

381 AVARA DİŞLİSİ/SPLIT IDLER WHEEL

M Kalıplı Güçlendirilmiş Polyamid/Reinforced Polyamide

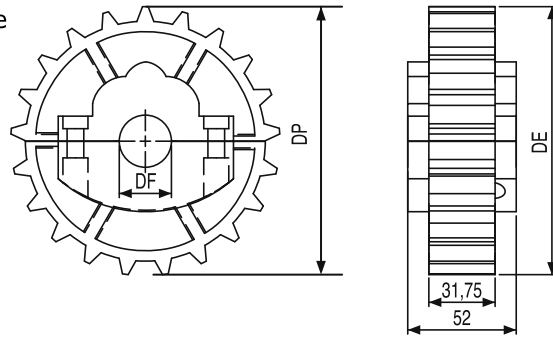

Z-İmalat Şekil Manufacture	DE	DP	DF	Kg	Stok Kod Stock Code	
21- Kalıplı - Molding	129	129,26	25	0,40	381 825 021	8
21- Kalıplı - Molding	129	129,26	30	0,40	381 830 021	
21- Kalıplı - Molding	129	129,26	35	0,40	381 835 021	
21- Kalıplı - Molding	129	129,26	40	0,40	381 840 021	
21- Kalıplı - Molding	129	129,26	45	0,40	381 845 021	
23- Kalıplı - Molding	141	141,22	25	0,46	381 825 023	
23- Kalıplı - Molding	141	141,22	30	0,46	381 830 023	
23- Kalıplı - Molding	141	141,22	35	0,46	381 835 023	
23- Kalıplı - Molding	141	141,22	40	0,46	381 840 023	
23- Kalıplı - Molding	141	141,22	45	0,46	381 845 023	
25- Kalıplı - Molding	153	153,20	25	0,64	381 825 025	
25- Kalıplı - Molding	153	153,20	30	0,64	381 830 025	
25- Kalıplı - Molding	153	153,20	35	0,64	381 835 025	
25- Kalıplı - Molding	153	153,20	40	0,64	381 840 025	
25- Kalıplı - Molding	153	153,20	45	0,64	381 845 025	

*Özel üretim yapılır./On request special production is available.

TAŞIYICI KOVA/ELEVATOR BUCKETS

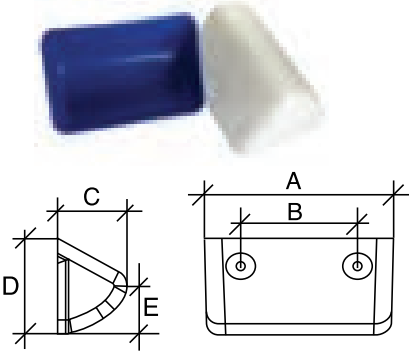

TASARIM/DESIGN 1 TASARIM/DESIGN 2

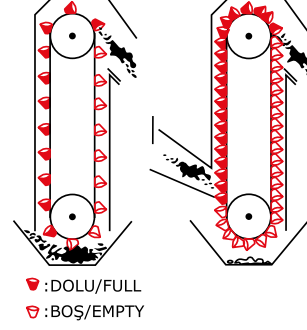

Model	Renk Colors	Ölçüler/Dimensions (mm)					Delikler/Holes ø mm	Litre Liter	Ağırlık Weight (gr)	Sertlik Hardness °Sh	Vida Screw	Stok Kod Stock Code	
		A	B	C	D	E							
EK0 100	Beyaz/White	106	91	49	89	45	7	0,20	57	62 D	M6x25	999 EKO 020	12
EK0 120	Beyaz/White	126	105	63	105	55	7	0,30	108	62 D	M6x25	999 EKO 030	12
EK0 140	Beyaz/White	145	111	80	120	63	7	0,50	120	62 D	M6x25	999 EKO 050	12
EK0 160	Beyaz/White	169	123	98	132	68	7	0,75	158	62 D	M6x25	999 EKO 075	12
EK0 180	Beyaz/White	188	137	104	138	75	7	1,10	201	62 D	M6x25	999 EKO 110	10
EK0 200	Beyaz/White	206	147	117	140	70	9	1,19	250	62 D	M8x30	999 EKO 119	10
EK0 230	Beyaz/White	237	157	75	152	82	10	1,50	290	62 D	M10x40	999 EKO 150	10
* EK0 250	Beyaz/White	263	155	78	164	82	17	1,99	423	62 D	M10x40	999 EKO 199	8
EK0 315	Beyaz/White	337	190	110	195	103	17	3,36	625	62 D	M10x40	999 EKO 336	4
EK1 100	Mavi/Blue	110	90	50	90	47	7	0,24	74	62 D	M6x25	999 EK1 024	12
EK1 120	Mavi/Blue	129	106	64	106	58	7	0,41	140	72 D	M6x25	999 EK1 041	12
EK1 140	Mavi/Blue	145	113	81	120	64	7	0,53	155	72 D	M6x25	999 EK1 053	12
EK1 160	Mavi/Blue	170	125	98	132	69	7	0,79	202	72 D	M6x25	999 EK1 079	12
EK1 180	Mavi/Blue	190	137	105	140	78	7	1,14	255	72 D	M6x25	999 EK1 114	10
EK1 200	Mavi/Blue	210	147	119	143	74	9	1,23	327	72 D	M6x25	999 EK1 123	10

 **Malzeme/Material: ALPOLEN®**

Gerekli detay için www.alhan-cagri.com sitesine bakabilirsiniz.
You can visit www.alhan-cagri.com for more details.



*Özel üretim yapılır./On request special production is available.

AKTARMA TAVASI/MODULAR TRANSFER PLATES WITHS ROLLERS

M SS PBT POM

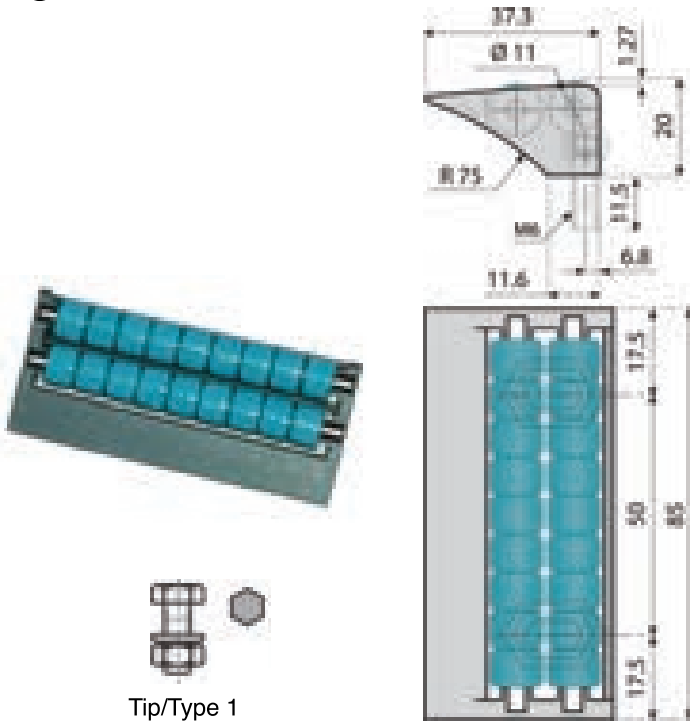

Tip/Type 1

Stok Kod Stock Code	
800 167 077	25

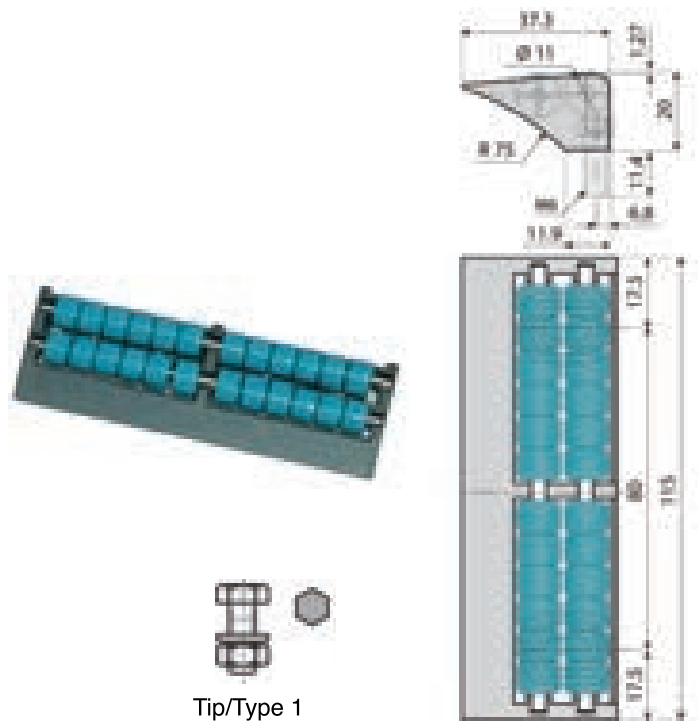

Tip/Type 1

Stok Kod Stock Code	
800 167 078	25

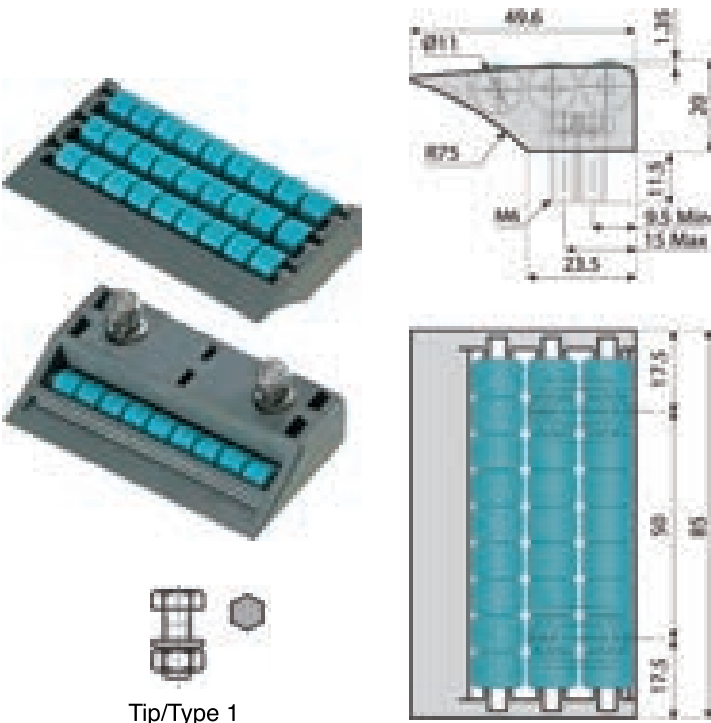

Tip/Type 1

Stok Kod Stock Code	
800 167 070	25

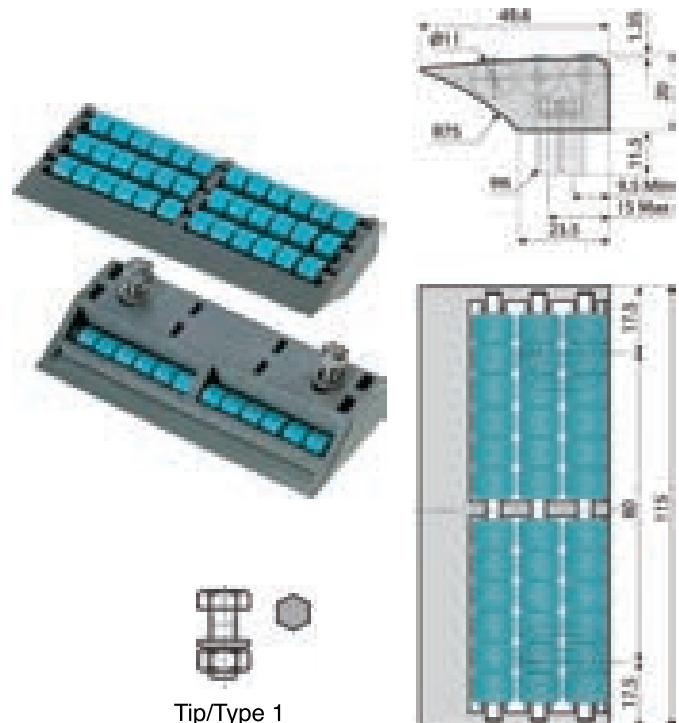

Tip/Type 1

Stok Kod Stock Code	
800 167 071	25

AKTARMA TAVASI/MODULAR TRANSFER PLATES WITHS ROLLERS

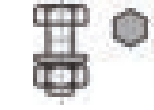
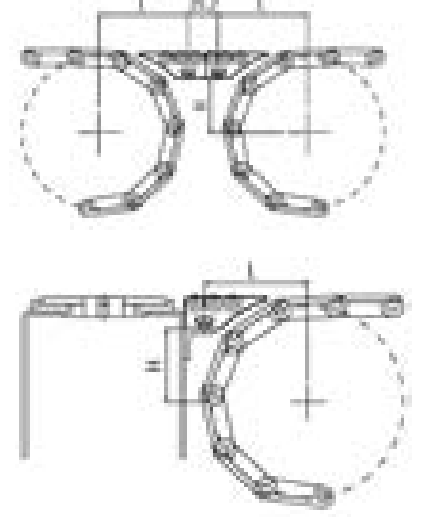
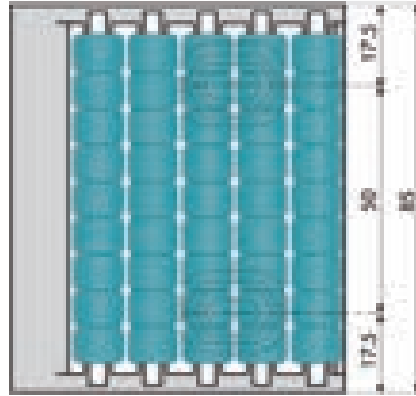
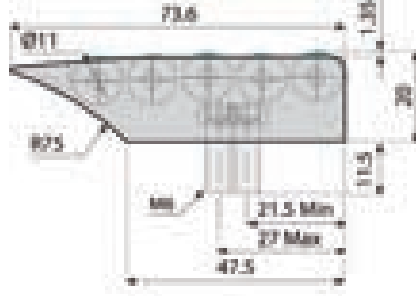
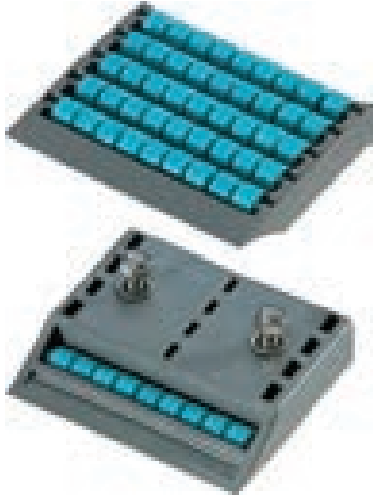

Tip/Type 1

Stok Kod Stock Code	
800 167 072	25

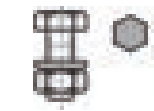
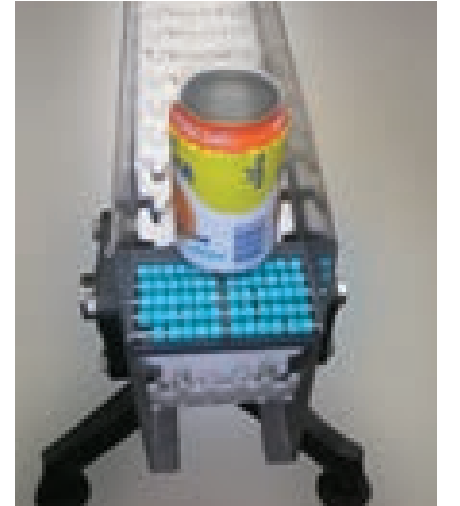
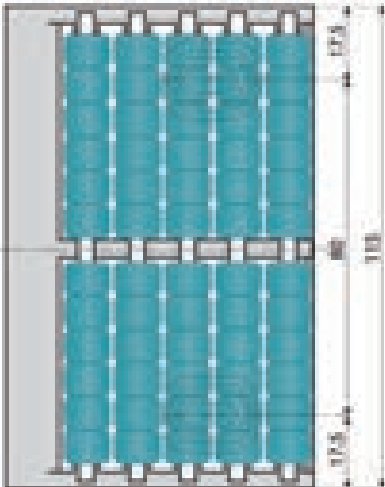
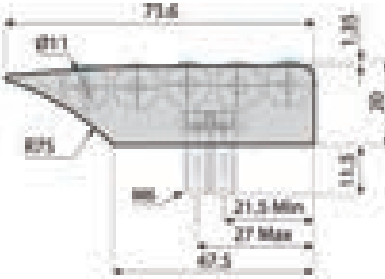

Tip/Type 1





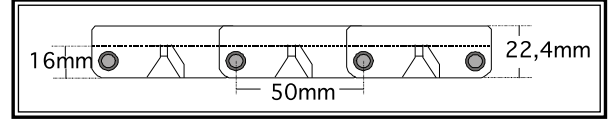
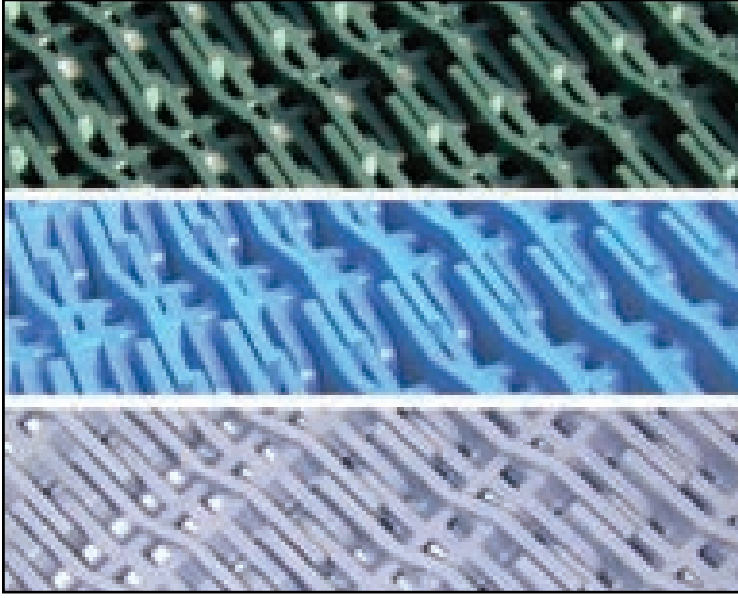

Stok Kod Stock Code	
800 167 073	25

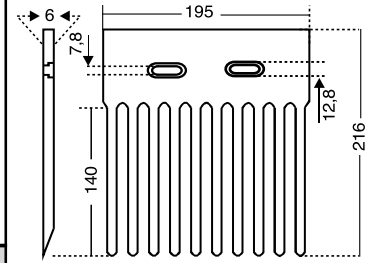
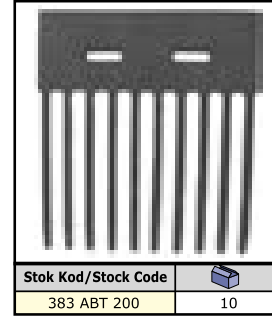

S2400-1HASIR BANT/MODULAR CONVEYOR BELTS

Bantın kullandığı endüstri alanları:
The belt is suitable for usage in industries
1-Konserve endüstrisi/Conversations
2-Şişeleme endüstrisi/Bottling



	PP	PTV(3*)	PPGF(3*)	PE	AC(3*)
Renk Colour (2*)	gri/grey 	mavi / blue 	yeşil / green 	beyaz / white 	kırmızı / red 
Taşıyacağı Yük Strength max (Kg/m)	4000	3900	4400	3000	5400
Sıcaklık Temperature (°C)	+1 - +105	+1 - +105	+1+ 105	-60 +65	-40 +85
Açıklık Open Surface	26%	26%	26%	26%	26%
Adım Pitch (mm)	50	50	50	50	50
Ağırlık Weight (Kg/m²)	11,3	13,6	12,4	11,8	17,4
Dişli'den Olan Uzaklık Distances between the sprockets Z12	90 mm	90 mm	90 mm	90 mm	90 mm
Stok Kod Stock Code	830 D01 G01	830 D03 M01	830 D04 Y01	830 D02 B01	830 D05 K01
	br	m	m	m	m

(*) : PP : Polipropilen/Polypropylene

PTV : Suda kullanıma uygun Polipropilen/Polypropylene self-sunk in water

PPGF : Güçlendirilmiş Polipropilen/Special self sunk plastic and resistant in thin acids

PE : Polietilen/Polyethylene

AC : Poliasetal/Polyacetal

(2*) : Özel renk talep durumunda stok dışı çalışıldığı için belirtilmesi gerekir.

Some colours are not existing in continous stock.

(3*) : Özel tasarım durumunda stok dışı çalışıldığı için belirtilmesi gerekir.

The constuction of the belts with these materials is realized

*830 D01 Z01... Detaylı bant genişlikleri ve stok kod bilgilerine

*830 D01 Z01... For more belt width and stock code details, you can look



sayfalarından ulaşabilirsiniz.
at this page

S2400-2 HASIR BANT/MODULAR CONVEYOR BELTS

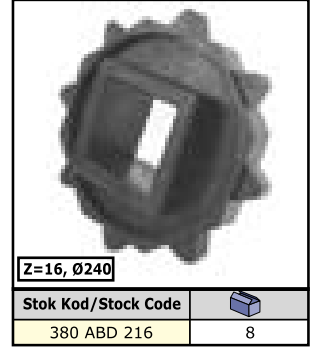
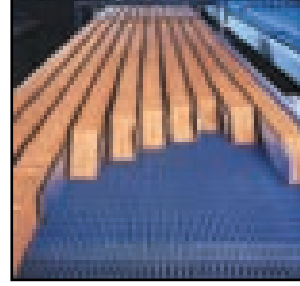
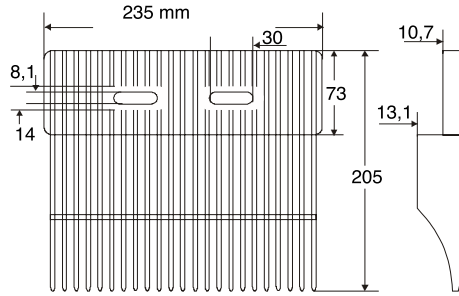
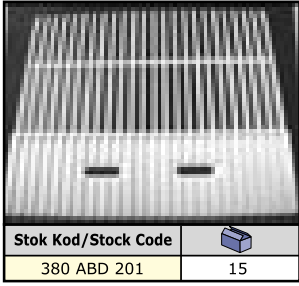
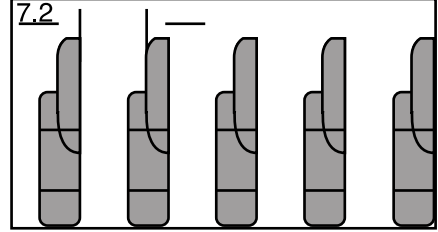
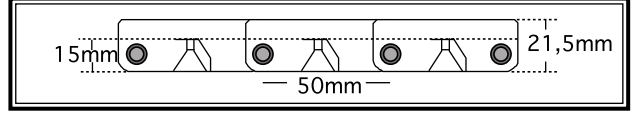
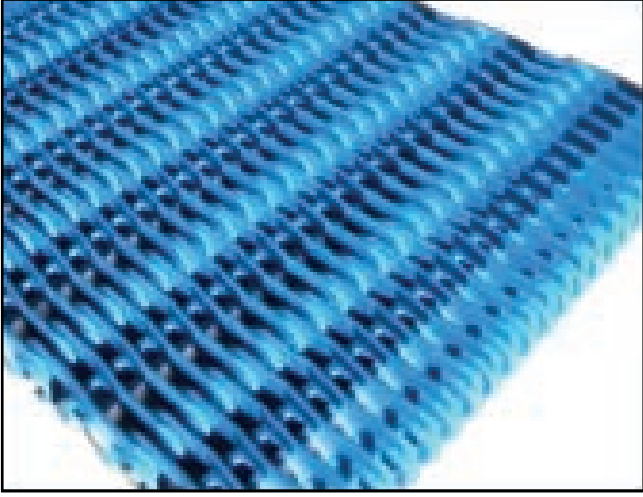

Bantın kullandığı endüstri alanları:
The belt is suitable for usage in industries:
1- **Konserve endüstrisi/Conservations.**
2- **Şişeleme endüstrisi/Bottling**

	PP	PTV(3*)	PPGF(3*)	PE	AC(3*)
Renk Colour (2*)	gri/grey 	mavi / blue 	yeşil / green 	beyaz / white 	kırmızı / red
Taşıyacağı Yük Strength max (Kg/m)	4000	3900	4400	3000	5400
Sıcaklık Temperature (°C)	+1 - +105	+1 - +105	+1+ 105	-60 +65	-40 +85
Açıklık Open Surface	26%	26%	26%	26%	26%
Adım Pitch (mm)	50	50	50	50	50
Ağırlık Weight (Kg/m²)	11,2	13,5	12,3	11,7	17,3
Dişli'den Olan Uzaklık Distances between the sprockets Z16	90 mm	90 mm	90 mm	90 mm	60 mm
Stok Kod Stock Code	830 E01 G01	830 E03 M01	830 E04 Y01	830 E02 B01	830 E05 K01
	br	m	m	m	m

(*) : PP : Polipropilen/Polypropylene
PTV : Suda kullanıma uygun Polipropilen/Polypropylene self-sunk in water
PPGF : Güçlendirilmiş Polipropilen/Special self sunk plastic and resistant in thin acids
PE : Polietilen/Polyethylene
AC : Poliasetal/Polyacetal

(2*) : Özel renk talep durumunda stok dışı çalışıldığı için belirtilmesi gerekir. Some colours are not existing in continous stock.
(3*) : Özel tasarım durumunda stok dışı çalışıldığı için belirtilmesi gerekir. The constuction of the belts with these materials is realized

*830 E01 Z01... Detaylı bant genişlikleri ve stok kod bilgilerine

*830 E01 Z01... For more belt width and stock code details, you can look



sayfalarından ulaşabilirsiniz. at this page

TEKNİK BİLGİ (HASIR BANT İÇİN)/TECHNICAL INFORMATION (FOR MODULAR BELTS)

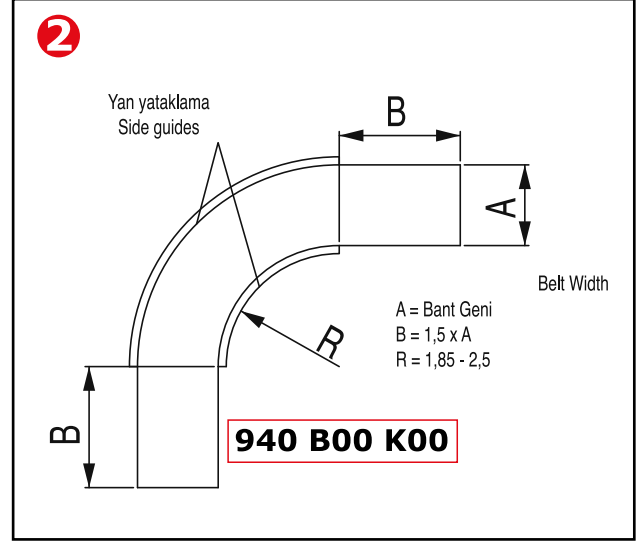
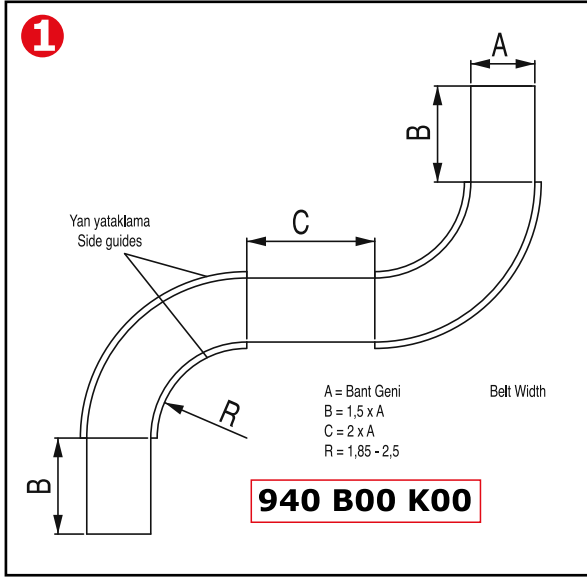

1 İÇ VE DIŞA DÖNÜŞLÜ KONVEYÖR BANT GENİŞLİĞİ TASARIMI
INNER AND OUTER CURVED CONVEYOR BELT WIDTH DESIGN

2 İÇ DÖNÜŞLÜ KONVEYÖR BANT GENİŞLİĞİ TASARIMI
INNER CURVED CONVEYOR BELT WIDTH DESIGN

3 İÇ VEYA DIŞA DÖNÜŞLÜ KONVEYÖR BANT YATAKLAMA TASARIMI
INNER OR OUTER CURVED CONVEYOR BELT SIDE DRIVES DESIGN
YATAKLAMA MALZEMESİ OLARAK ALPOLEN® 1000 VEYA ALPOLEN® 500 TAVSİYE ETMEKTEYİZ.
GEREKLİ BİLGİYİ E KATALOĞUNDA BULABİLİRSİNİZ
WE SUGGEST ALPOLEN® 1000 OR ALPOLEN® 500 FOR SIDE DRIVES MATERIAL.
YOU CAN LOOK "E" CATALOGUE FOR THIS INFORMATION

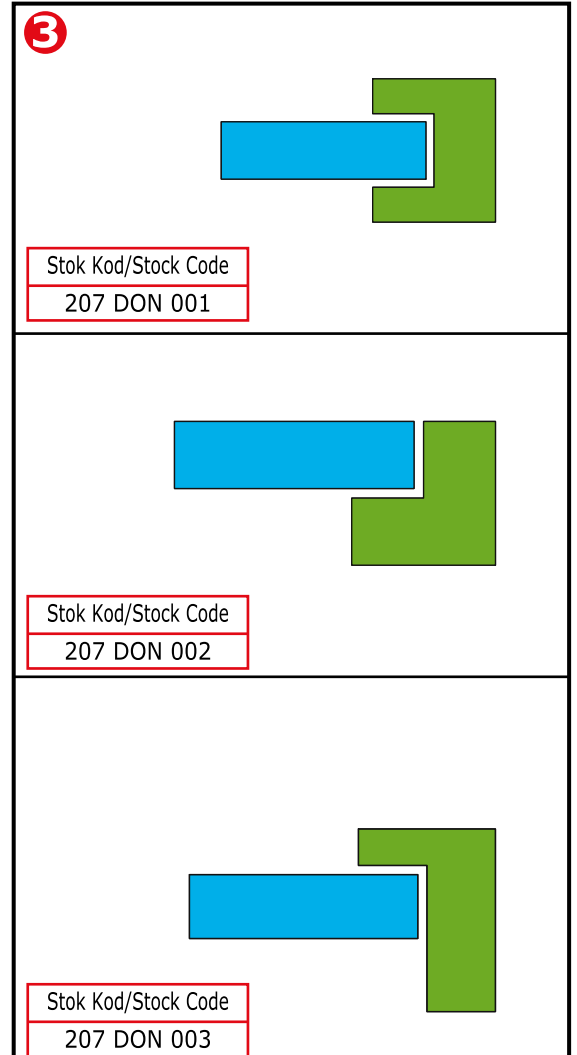

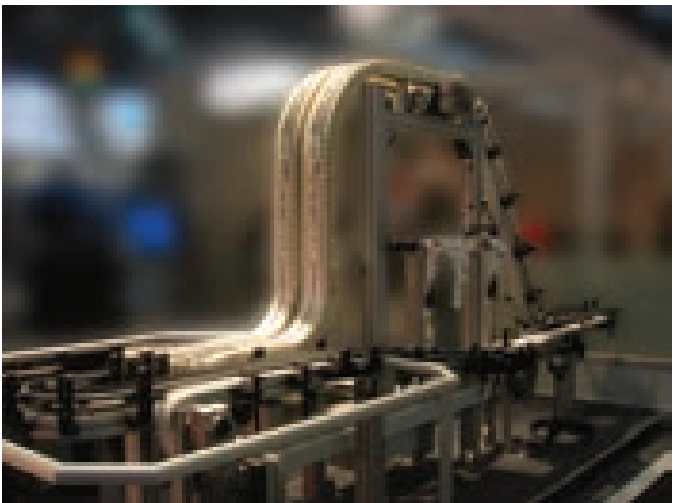



ÇAĞRI[®]
ENDÜSTRİ A.Ş.

ALHAN[®]

SÜRTÜNME PROFİLLERİ ve ZİNCİR KIZAKLARI
FRICITION GUIDES & ROLLER CHAIN GUIDES

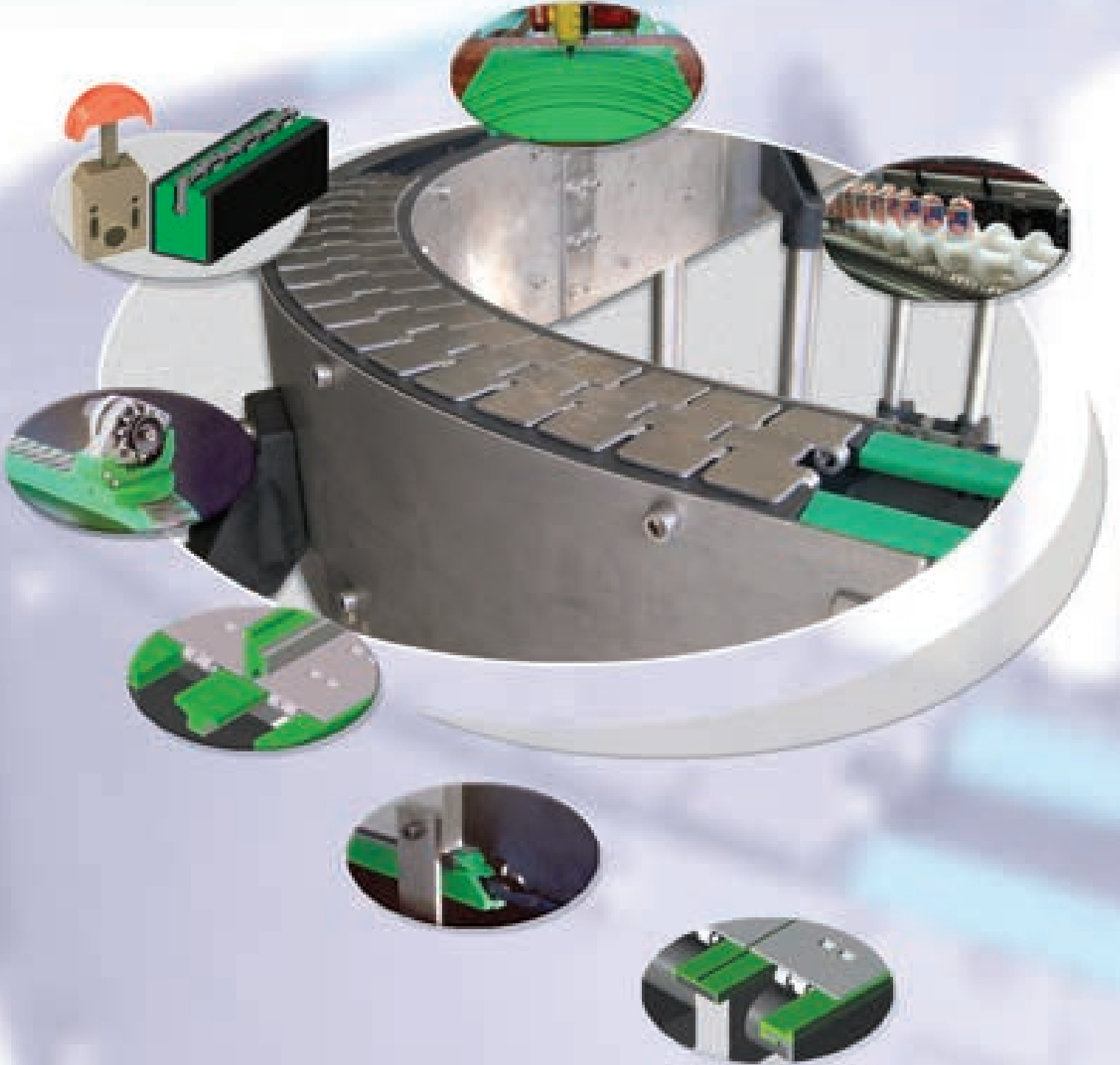



ÇAĞRI[®]
ENDÜSTRİ A.Ş.

ALHAN[®]

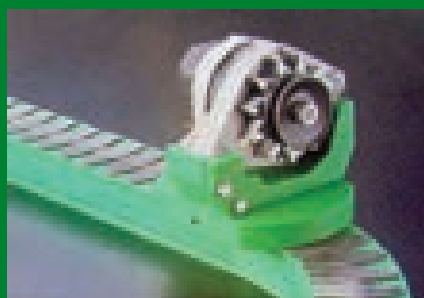
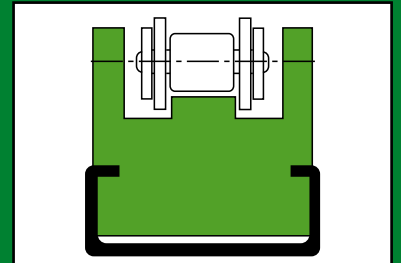
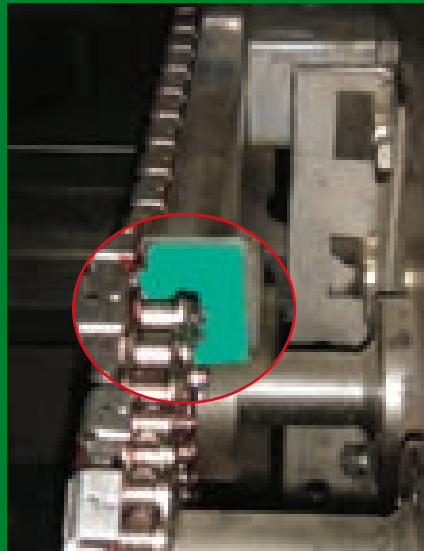
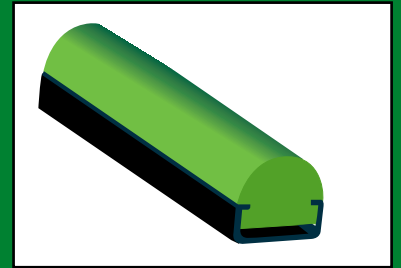
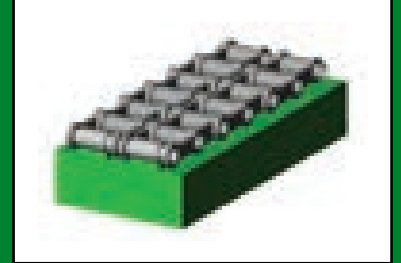
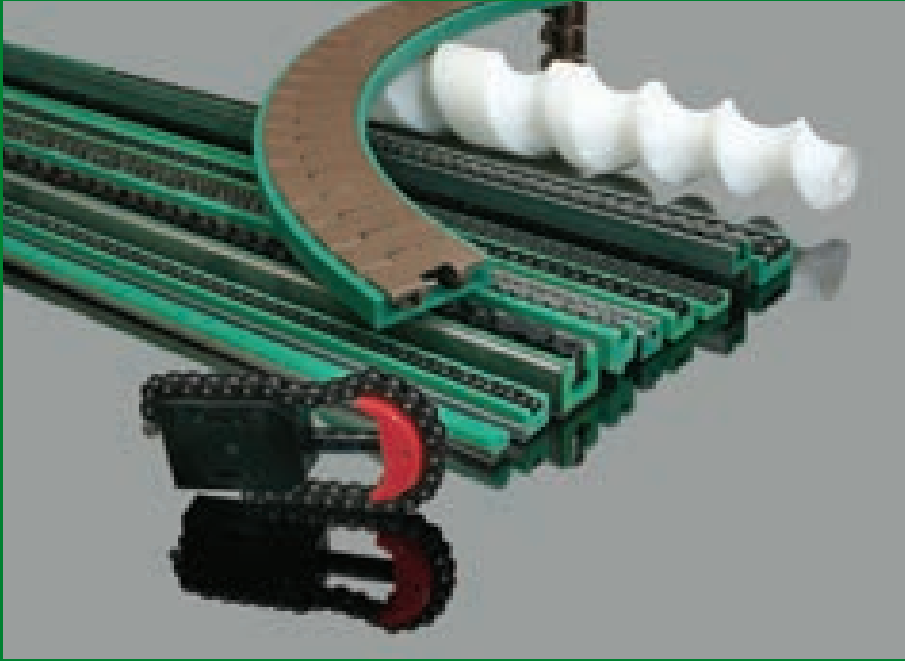

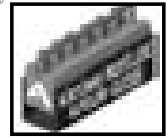
ALPOLEN® 1000 - ALPOLEN® 500 - ALPOLEN® 2000

Malzeme katsayısının düşük olması, kimyasal etkilere karşı dayanıklı olması, gıda ile etkilere dayanıklı olması, yumuşak malzeme olması ile özellikle tekstil, gıda ve içecek sanayilerinde kullanılmasını sağlamıştır. Moleküler ağırlığının artırılması ile teknik özellikler artmaktadır. Artan moleküler ağırlıkta şu özellikler artmaktadır. İç dayanım, yüksek sıcaklıklarda gerilme mukavemeti, güç sarfiyatı, çatlama ve aşınma gerilmesine karşı dayanım, mükemmel düşük sıcaklık performansı.

Kimliği:

Yoğunluk	: 0,96 gr / cm ³	Bozunum faktörü	: 0,005 (10 ^{3.2} HZ)
Erime noktası	: 130 °C	Eğilme mukavemeti	: 300 kg / cm ²
Sertlik	: m 53 Rockwell	Yüzeysel dayanım	: orta
Azami Çalışma Sıcaklığı	: 80 °C	Gerilme mukavemeti	: 260 kg / cm ²
Kopma uzaması	: %800	Elektrik yalıtkanlığı	: 2,4 (10 ^{3.2} HZ)
Isı ile bozunum	: 55 - 80 °C	İşlenebilirlik	: iyi
Su absorpsyonu (emme):	%0,1	Işık yalıtkanlığı	: zayıf
Isısal genleşme kats.	: 2.10 ⁻⁴	Besinlerle temas	: çok iyi
Sürtünme katsayısı	: 0,20	Asitlere dayanım	: iyi
Basma mukavemeti	: 300 kg / cm ²	Bazlara dayanım	: iyi

Yarımamül sevkiyatları	:
Yuvarlak malzemeleri	: Ø 10 mm'den Ø 300 mm'kadar
Plaka malzemeleri	: 5 mm'den 100 mm'kadar

Ayrıca isteğe göre düzenlenir.

Alpolen® 1000 : UHMW PE	: Moleküler ağırlığı 3,5.10 ⁶ ile 10,5.10 ⁶ gr/mol çok yüksek moleküler ağırlık
Alpolen® 500 : HMW PE	: Moleküler ağırlığı 500.000 gr/mol yüksek moleküler ağırlık
Alpolen® 2000 : UHMW PE	: Moleküler ağırlığı 3,5.10 ⁶ gr/mol'den büyük çok yüksek moleküler ağırlık

Kullanım sahaları :
Kömür depolarında konveyör sistemlerinde, oluklarda, zincir konveyör klavuzlarında, kovalı elevatörlerde, elektrik güç istasyonlarında, çimento, kireç, alçı, besin gıda endüstrilerinde, kesme ve doğrama plakaları, doğrama blokları, konveyör vidaları, kayma elemanları, yassı klavuzlar, profiller, makaralar, yıldız ve vida konveyörlerinde, elevatör sistemleri için, ayakkabı hattı klavuzu, kaymalı yataklarda vites dişlilerinde, motor indirme levhalarında, stop valfleri, kapama klapelerinde, pompalar fitreler ve diğerleri.

ALPOLEN® 500

Molekül ağırlığı + / -500.000 olan Alpolen®'dir. Alpolen® 500 yüksek molekül ağırlığından dolayı daha sert bir polietilendir dolayısıyla kullanım alanları için çok uygundur. Sürtünme katsayısı düşük, makinede işlenebilirliği çok mükemmeldir.

Zayıf nokta: Diğer mühendislik plastikleri ile karşılaştırıldığında düşük termal ve mekanik özelliklere, gerilme kuvvetine, esnek ve sıkıştırıcı kuvvete sahiptir. Yüksek molekül ağırlıklı Alpolen® 1000 ve 500 karşılaştırıldığında, 1000 malzemenin daha sert ve sürekli şok anında mukavemetinin daha yüksek olduğu anlaşılmıştır.

Gri : Şok mukavemet
Kırmızı: Gerilim kuvveti
Yüksek molekül ağırlığı, yüksek şok mukavemetini gösteren tabloya göre düşüşler gözlenir.

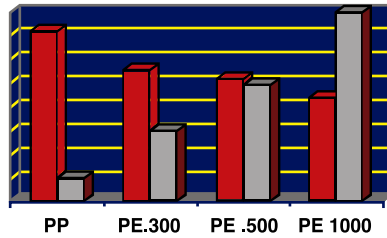

Alpolen® 1000 ve 500 malzemeye ait daha geniş teknik bilgi ve teknik uygulamalar için lütfen

www.alhan-cagri.com

sitesini ziyaret ediniz.

ALPOLEN® 2000

Alpolen® molekül ağırlığı > 3,5 milyon gr/mol çok yüksek moleküler ağırlığa sahiptir (UHMW Ultra High Molecular Weight) alev geciktirici, Holojen geçirgenliği, antistatik özellik, UV ışığı altında dışarda kullanım, Ağır tip uygulamalar için yüksek sürtünme dayanımı, Antibakteriyel gibi nitelikler (FDA ile BfR) kazandırılarak geliştirilmiş UHMW (çok yüksek moleküler ağırlıklı) Polietilen malzemedir.

ALPOLEN® 1000

Alpolen® molekül ağırlığı 3,5 milyon gr/mol ile 10,5 milyon gr/mol arası olarak bilinen mükemmel sıkıştırma gücüne sahip bir malzemedir. Düşük moleküler ağırlıklı Alpolen® lere nazaran Alpolen® 1000, daha az sert ve daha yüksek şok mukavemetlerine sahiptir.

Sürekli devam eden şok durumları içeren kullanım alanlarına uygundur.

Özellikleri : Yüksek kimyasal mukavemet, düşük aşınma, sürtünme katsayısı düşüktür. Natural renkte, kolay işlenebilir. Zayıf nokta : Diğer mühendislik plastikleri ile karşılaştırıldığında düşük temas ve mekanik özelliklere, gerilme kuvvetine, esnek ve sıkıştırma kuvvetine sahiptir.

Kullanım alanları: Sahip olduğu özellikler açısından gıda ile temas edebilir. Özellikle geniş kullanım alanı vardır, gıda makineleriyle kullanılır. Asitlere ve alkalilere karşı yüksek mukavemet gösterdiği için kimya endüstrisinde tercih edilir. Elektrik endüstrisinde yüksek dielektrik özelliklerinden ve hür türlü havaya dayanıklı olmasından dolayı kullanılır. Düşük sürtünme katsayılı olmasından dolayı, mil yatağı, mekanik parçalar yapımında ve -su içinde dahi- operasyon olduğunda tercih edilir.

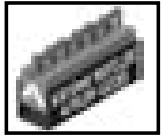
ALPOLEN® 1000 - ALPOLEN® 500 - ALPOLEN® 2000

Polyethylene with a molecular weight of +/- 3,5.10⁶ with 10,5.10⁶ PE UMWH 1000 is more rigid than the high molecular weight polyethylene (PE 500) and it is therefore more suitable for mechanical applications. The friction coefficient is low and machinability is excellent.

FEATURES

Chemical: high chemical resistance typical of the polyolefins
 Shock resistance, good even at low temperature
 High abrasion resistance
 Low friction coefficient
 Low specific gravity
 Easy machinability
 colour: natural

Identity:

Density	: 0,96 g/cm ³	Prolonged Factor	: 0,005 (10 ³ .2HZ)
Melt Temperature	: 130 °C	Bending Strength	: 300 kg / cm ²
Hardness	: m 53 Rockwell	Surface Resistance	: Normal
Working Temperature	: 80°C	Tension Strength	: 260 kg / cm ²
Breaking Prolonged	: %800	Dielectric Strength	: 2,4 (10 ³ .2HZ)
Thermal Prolonged	: 55 - 80°C	Behaviour in Manufacturing	: good
Water Absorption	: %0,1	Light Resistance	: weak
Thermal Expanding	: 2.10 ⁻⁴	Food Available	: well
Friction Coefficient	: 0,20	Acid Resistance	: good
Pressing Strength	: 300 kg/cm ²	Base Resistance	: good

WEAK POINT

Compared to the engineering plastics it has lower thermal and mechanical properties : tensile stress, flexural and compressive strength, etc. Compared to high molecular weight PE, it is more rigid and its resistance to continuous shock is therefore lower

APPLICATION

Food contact: physiologically inert, it is approved for food contact by the most important standards. Thanks to this feature, it is widely used for components in food machinery, pumps for liquid food etc.

Chemical: thanks to the high resistance to acids and alkali it is used to produce components ifor the chemical industry.

Electrical: very good dielectric properties, weatherproof.

Mechanical: the low friction coefficient and its non hygroscopicity make it suitable for use as a bearing or for mechanical parts with low loads, even when operating in water.

The graph shows that the higher the molecular weight is, the higher the shock resistance, but that tensile stress decreases.

Red : tensile stress

Grey: shock resistance

ALPOLEN® 2000

Modified for the specific applications of our customers.

- With antistatic finish and additional lubricant for the conveyor industry.
- With added antioxidants, for example, which can be used at high temperatures.
- With additional flame retardant properties for use in rail vehicle, machinery and mining construction.
- With enhanced antibacterial effects.

Ultra-high molecular weight low pressure polyethylene with a molecular weight 3.500.000 g/mol plus additives for the improvement of specific metarial properties.

ALPOLEN® 500

Polyethylene with a molecular weight of +/- 500.000 with semi-finished products made of ALPOLEN® 500 we offer you a material which, thanks to its characteristics, quality and price, is the first choice for many applications. Particularly in the food industry and in sports centre construction, ALPOLEN® 500 does an excellent job with its impact strength and insulating properties — and that at competitive costs.

ALPOLEN® 500 complies in full with all applicable regulations for contact with food. In addition to its use as a cutting board, as lining or as impact protection, it is also useful in other applications, for example in machine construction.

FEATURES

Shock resistance, good even at low temperatures
 High chemical resistance typical of the polyolefins
 High abrasion resistance
 Low friction coefficient
 Low specific gravity
 Easy machinability
 colour: natural

WEAK POINT

Compared to the engineering plastics it has lower thermal and mechanical properties: tensile stress, flexural and compressive strength, etc. Compared to low molecular weight PE, it is less rigid.

APPLICATION

Food contact : physiologically inert, it is approved for food contact by the most important standards. Thanks to this feature, it is widely used for components in food machinery, pumps for liquid food etc.

Chemical: thanks to the high resistance to acids and alkali it is used for components in the chemical industry

Electrical : very good dielectric properties, weatherproof

Mechanical: the low friction coefficient and its non hygroscopicity make it suitable for use as a bearing or mechanical parts with low loads, even when operating in water.

The graph shows that the higher the molecular weight is, the higher the shock resistance, but that tensile stress decreases.

Red : tensile stress

Grey: shock resistance

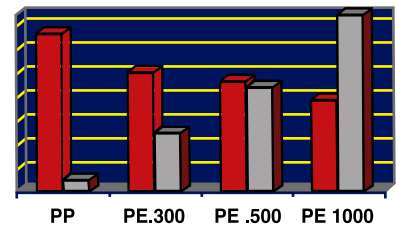

Alpolen® 1000 and 500 for more technical details and application please you can visit

www.alhan-cagri.com

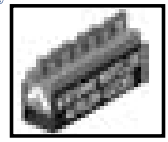

Z PROFİL ALPOLEN® 1000/GUIDES FOR BOTTLING AND PACKAGING

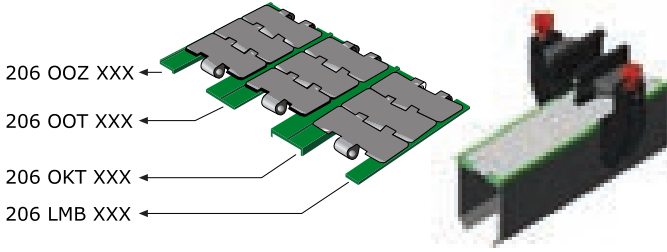

206 OÖZ XXX
206 OÖT XXX
206 OKT XXX
206 LMB XXX

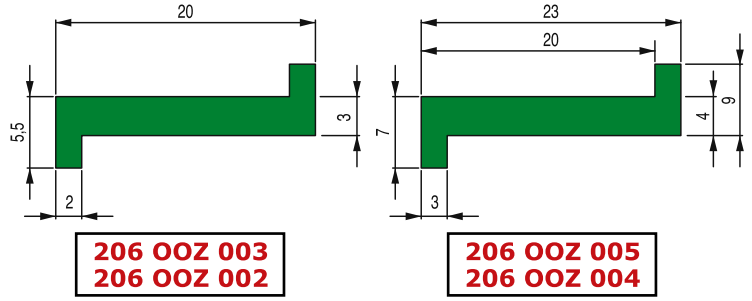

206 OÖZ 003
206 OÖZ 002

206 OÖZ 005
206 OÖZ 004

Profil Bölümü/Profiles: "Z"				
	Açıklama Characteristic	L	Kg/m	Stok Kod Stock Code
Alpolen® 1000 - Yeşil / Green	Section Z	60	0,07	206 OÖZ 003
Alpolen® 1000 - Siyah / Black	Section Z	60	0,07	206 OÖZ 002
Alpolen® 1000 - Yeşil / Green	Section Z	60	0,12	206 OÖZ 005
Alpolen® 1000 - Siyah / Black	Section Z	60	0,12	206 OÖZ 004

L: Standart Uzunluk (metre)/Standart Length (meter)

DÜZ LAMA PROFİL ALPOLEN® 1000/FLAT GUIDES

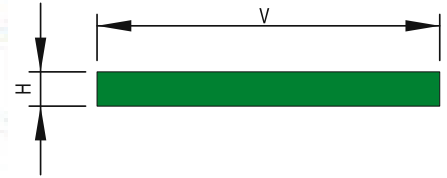
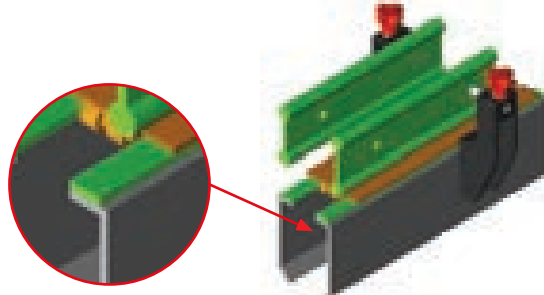

Profil Bölümü/Profiles: "LAMA"										
	L	H	V							
			15	20	25	30	35	40	45	50
Alpolen® 1000 - Yeşil / Green	60	3	206 LMY 315	206 LMY 320	206 LMY 325	206 LMY 330	206 LMY 335	206 LMY 340	206 LMY 345	206 LMY 350
Alpolen® 1000 - Siyah / Black	60	3	206 LMS 315	206 LMS 320	206 LMS 325	206 LMS 330	206 LMS 335	206 LMS 340	206 LMS 345	206 LMS 350
Alpolen® 1000 - Yeşil / Green	60	5	206 LMY 515	206 LMY 520	206 LMY 525	206 LMY 530	206 LMY 535	206 LMY 540	206 LMY 545	206 LMY 550
Alpolen® 1000 - Siyah / Black	60	5	206 LMS 515	206 LMS 520	206 LMS 525	206 LMS 530	206 LMS 535	206 LMS 540	206 LMS 545	206 LMS 550

L: Standart Uzunluk (metre)/Standart Length (meter)

GEÇMELİ Z PROFİL ALPOLEN® 1000/GUIDES FOR BOTTLING AND PACKAGING

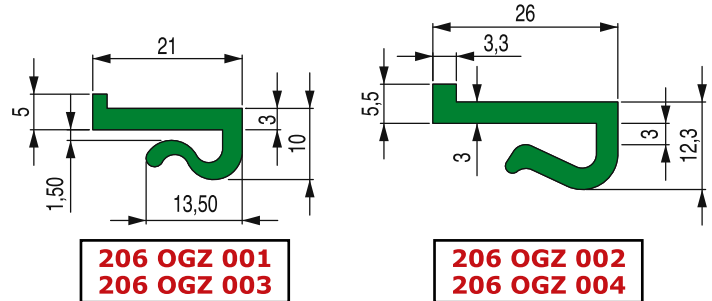
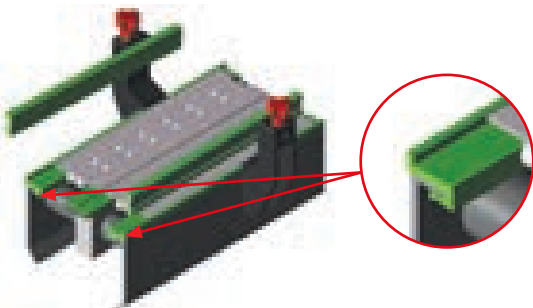

206 OGZ 001
206 OGZ 003

206 OGZ 002
206 OGZ 004

Profil Bölümü/Profiles: "Z"				
	Açıklama Characteristic	L	Kg/m	Stok Kod Stock Code
Alpolen® 1000 - Yeşil / Green	P/P 20m.	60	0,12	206 OGZ 001
Alpolen® 1000 - Siyah / Black	P/P 20m.	60	0,12	206 OGZ 003
Alpolen® 1000 - Yeşil / Green	P/P 25	60	0,17	206 OGZ 002
Alpolen® 1000 - Siyah / Black	P/P 25	60	0,17	206 OGZ 004

L: Standart Uzunluk (metre)/Standart Length (meter)

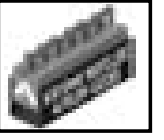

GEÇMELİ LAMA PROFİL ALPOLEN® 1000/GUIDES FOR BOTTLING AND PACKAGING

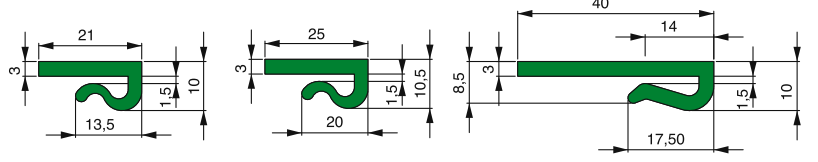
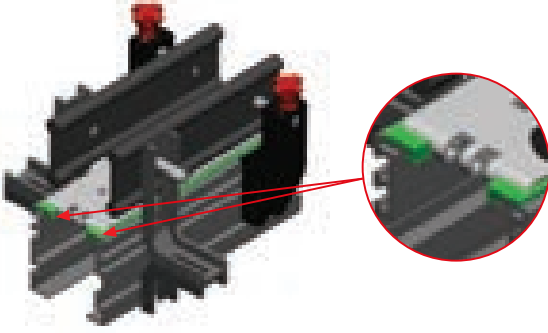

206 GLA 100
206 GLA 101

206 GLA 102
206 GLA 103

206 GLA 108
206 GLA 109

Kullanılacak Profil 1,5-3 mm kalınlığındadır.
Wearstrip to be used with plate width of 1,5 to 3mm.

Profil Bölümü/Profiles: "LAMA"				
	Açıklama Characteristic	L	Kg/m	Stok Kod Stock Code
Alpolen® 1000 - Yeşil / Green	P20	60	0,11	206 GLA 100
Alpolen® 1000 - Siyah / Black	P20	60	0,11	206 GLA 101
Alpolen® 1000 - Yeşil / Green	P25	60	0,11	206 GLA 102
Alpolen® 1000 - Siyah / Black	P25	60	0,11	206 GLA 103
Alpolen® 1000 - Yeşil / Green	P40	60	0,16	206 GLA 108
Alpolen® 1000 - Siyah / Black	P40	60	0,16	206 GLA 109

L:Standart Uzunluk(metre)/Standart Length(meter)

L PROFİL ALPOLEN 1000®/GUIDES FOR BOTTLING AND PACKAGING

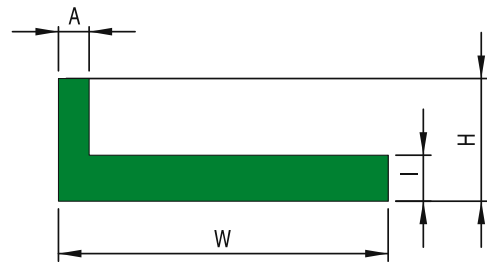
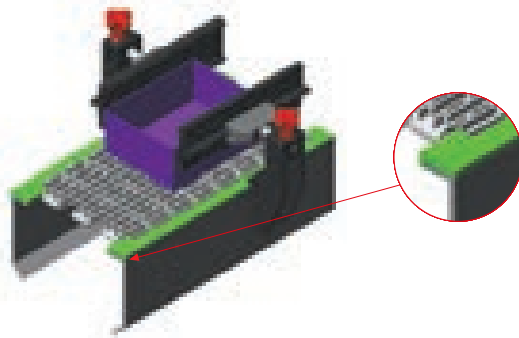

Profil Bölümü/Profiles: "L"								
	Açıklama/ Characteristic	W	A	H	I	L	Kg/m	Stok Kod Stock Code
Alpolen® 1000 - Yeşil / Green	L	20	2	5,5	3	60	0,06	206 OOL 001
Alpolen® 1000 - Siyah / Black	L	20	2	5,5	3	60	0,06	206 OOL 002
Alpolen® 1000 - Yeşil / Green	L	53	2	6	3	60	0,16	206 OOL 003
Alpolen® 1000 - Yeşil / Green	L	35	5	12	5	60	0,15	206 OOL 013
Alpolen® 1000 - Yeşil / Green	L	30	10	12	5	60	0,14	206 OOL 014
Alpolen® 1000 - Yeşil / Green	L	40	10	15	5	60	0,16	206 OOL 015

L:Standart Uzunluk(metre)/Standart Length(meter)

*Özel üretim yapılır./On request special production is available.

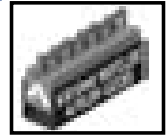

T PROFİL ALPOLEN® 1000/GUIDES FOR BOTTLING AND PACKAGING



Profil Bölümü/Profiles: "T"			
L		Kg/m	Stok Kod Stock Code
60	Alpolen® 1000 - Yeşil / Green	0,11	206 OOT 003
60	Alpolen® 1000 - Siyah / Black	0,11	206 OOT 004
L:Standart Uzunluk(metre)/Standart Length(meter)			

TCA PROFİL ALPOLEN® 1000/GUIDES FOR BOTTLING AND PACKAGING

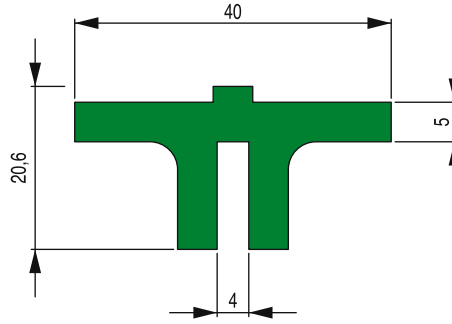

Profil Bölümü/Profiles: "T"			
L		Kg/m	Stok Kod Stock Code
6	Alpolen® 1000 - Yeşil / Green	0,30	206 UOT 001
6	Alpolen® 1000 - Siyah / Black	0,30	206 UOT 002
L:Standart Uzunluk(metre)/Standart Length(meter)			

TCAL PROFİL ALPOLEN® 1000/GUIDES FOR BOTTLING AND PACKAGING

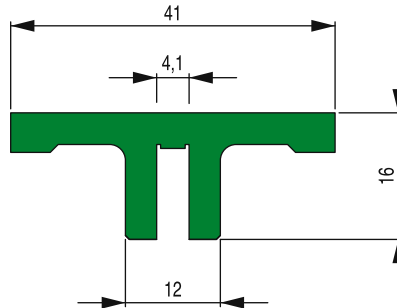

Profil Bölümü/Profiles: "T"			
L		Kg/m	Stok Kod Stock Code
2	Alpolen® 1000 - Yeşil / Green	0,29	206 DOT 001
2	Alpolen® 1000 - Siyah / Black	0,29	206 DOT 002
L:Standart Uzunluk(metre)/Standart Length(meter)			

*Özel üretim yapılır./On request special production is available.

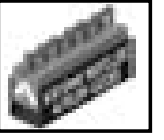

ALPOLEN® 1000 ÇELİK PROFİLLİ HCP KIZAKLARI/GUIDES FOR BOTTLING AND PACKAGING

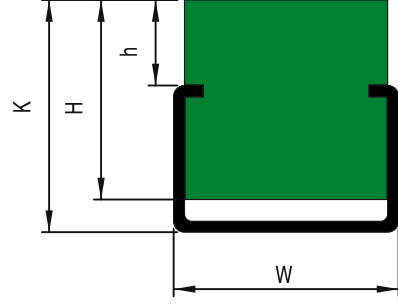

M	Kılavuz Guide	W	K	H	h	L	Kg/m	Stok Kod
								Stock Code
Alpolen® 1000 Yeşil / Green	C 2010 ZN	20	14	10	4	2	0,790	207 HCC 014
	C 2010 SS	20	14	10	4	2	0,790	207 HCP 014
	C 2010 ZN	20	17	15	7	2	0,880	207 HCC 017
	C 2010 SS	20	17	15	7	2	0,880	207 HCP 017
	C 2010 ZN	20	22	20	12	2	0,940	207 HCC 022
	C 2010 SS	20	22	20	12	2	0,940	207 HCP 022
	C 2812 ZN	28	15	10	3	2	1,180	207 HCC 015
	C 2812 SS	28	15	10	3	2	1,180	207 HCP 015
	C 2812 ZN	28	18	15	6	2	1,320	207 HCC 018
	C 2812 SS	28	18	15	6	2	1,320	207 HCP 018
	C 2812 ZN	28	24	20	12	2	1,488	207 HCC 024
	C 2812 SS	28	24	20	12	2	1,488	207 HCP 024
	C 3818 ZN	38	22	12	4	2	2,200	207 HCC 122
	C 3818 SS	38	22	12	4	2	2,200	207 HCP 122
	C 3818 ZN	38	24	15	6	2	2,460	207 HCC 124
	C 3818 SS	38	24	15	6	2	2,460	207 HCP 124
	C 3818 ZN	38	30	20	12	2	2,690	207 HCC 030
	C 3818 SS	38	30	20	12	2	2,690	207 HCP 030
C 6020 ZN	60	30	20	10	2	3,260	207 HCC 130	
C 6020 SS	60	30	20	10	2	3,260	207 HCP 130	

ALPOLEN® 1000 "C" SÜRTÜNME PROFİLLERİ/ "C" GUIDES FOR BOTTLING AND PACKAGING

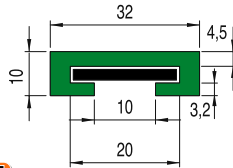
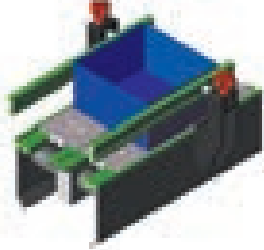

Lama 20x3
Flat Steel

207 CC3 012

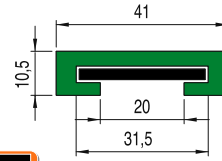

Lama 30x3
Flat Steel

207 CC4 010

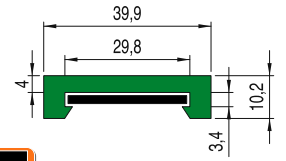

Lama 30x3
Flat Steel

207 CC5 015

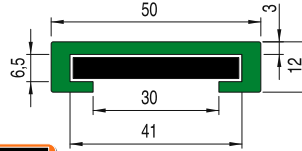

Lama 40x6
Flat Steel

207 CC5 014

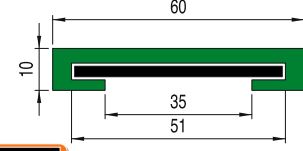

Lama 50x4
Flat Steel

207 CC6 012



M	L	Kg/m	Stok Kod
			Stock Code
Alpolen® 1000 Yeşil / Green	6	0,17	207 CC3 012
	6	0,19	207 CC4 010
	6	0,24	207 CC5 015
	6	0,26	207 CC5 014
	6	0,28	207 CC6 012

*Özel üretim yapılır./On request special production is available.

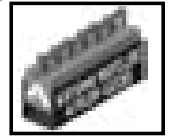

KULAKLI T PROFİL ALPOLEN® 1000/PROFILES OF BEVEL CHANNEL

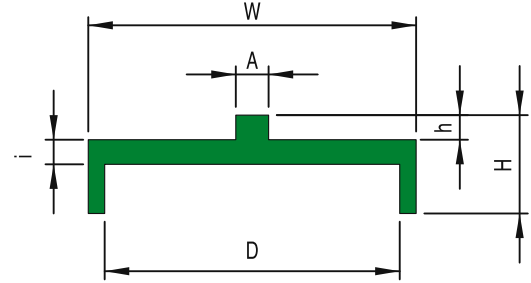
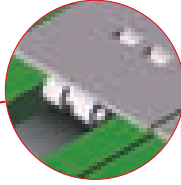
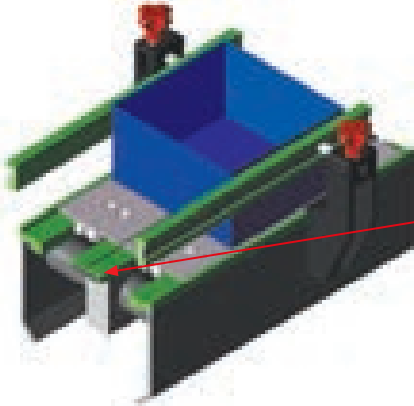

Profil Bölümü/Profiles: "T"

Açıklama/Characteristics	W	D	H	i	h	A	L	Ⓜ	Kg/m	Stok Kod Stock Code
DZ/30	40	30	12,5	2,5	2,5	4	6	Alpolen® 1000 - Yeşil / Green	0,13	206 OKT 401
DZ/36	40	36	9	3	3	4	6	Alpolen® 1000 - Siyah / Black	0,13	206 OKT 402
DZ/31	43	31	15	4	3	3	6	Alpolen® 1000 - Yeşil / Green	0,21	206 OKT 431
DZ/31	43	31	15	4	3	3	6	Alpolen® 1000 - Siyah / Black	0,21	206 OKT 432
DZ/32	44	32	8	3	3	4	6	Alpolen® 1000 - Yeşil / Green	0,16	206 OKT 441
DZ/32	44	32	8	3	3	4	6	Alpolen® 1000 - Siyah / Black	0,16	206 OKT 442
DZ/41	46	41	11,5	3	3	4	6	Alpolen® 1000 - Yeşil / Green	0,17	206 OKT 461
DZ/41	46	41	11,5	3	3	4	6	Alpolen® 1000 - Siyah / Black	0,17	206 OKT 462

L:Standart Uzunluk(metre)/Standart Length(meter)

ALPOLEN® 1000 "C" SÜRTÜNME PROFİLLERİ/ "C" GUIDES FOR BOTTLING AND PACKAGING

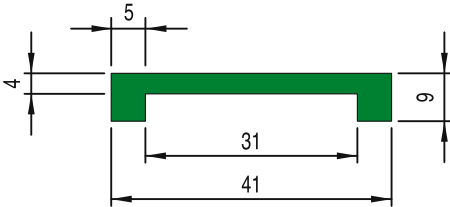

Profil Bölümü/Profiles: "YD"

L	Ⓜ	Kg/m	Stok Kod Stock Code
2	Alpolen® 1000 - Yeşil / Green	0,170	206 YD3 001
2	Alpolen® 1000 - Siyah / Black	0,170	206 YD3 002

L:Standart Uzunluk(metre)/Standart Length(meter)

ALPOLEN® 1000 SÜRTÜNME PROFİLLERİ/ GUIDES FOR BOTTLING AND PACKAGING

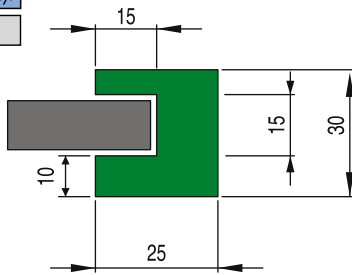

207 DON 001

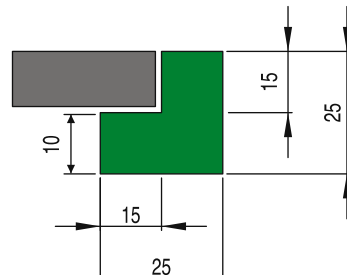

207 DON 002

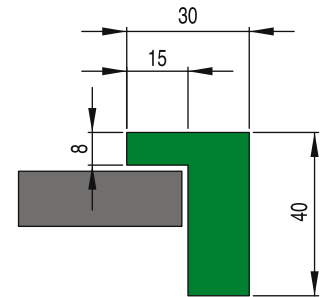

207 DON 003



Ⓜ	L	Kg/m	Stok Kod Stock Code
Alpolen® 1000 Yeşil / Green	2	0,75	207 DON 001
	2	0,64	207 DON 002
	2	0,68	207 DON 003

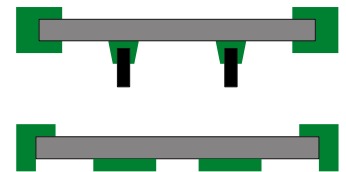

*Özel üretim yapılır./On request special production is available.

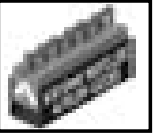



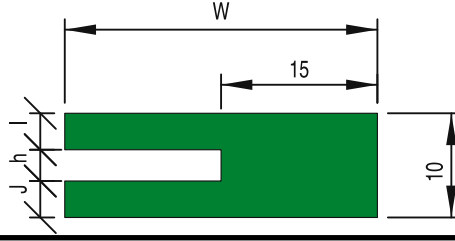



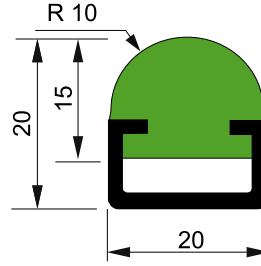
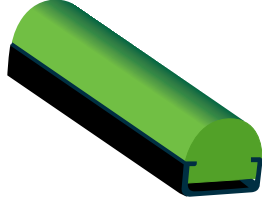

U/640 PROFİL ALPOLEN® 1000/GUIDES FOR BOTTLING AND PACKAGING



Profil Bölümü/Profiles: "U"											
W	H	A	I	h	J	L			Kg/m	Stok Kod Stock Code	
30	10	15	3.5	3	3.5	2	Alpolen® 1000 - Yeşil / Green		0,25	206 YU2 001	
								Alpolen® 1000 - Siyah / Black		0,25	206 YU2 002
L:Standart Uzunluk(metre)/Standart Length(meter)											

YUVARLAK BALIK SIRTİ PROFİL ALPOLEN® 1000/GUIDES FOR BOTTLING AND PACKAGING



Profil Bölümü/Profiles: BSA										
 Kılavuz/Guide	L								Kg/m	Stok Kod Stock Code
C 2010 SS 	2	Alpolen® 1000 - Yeşil / Green							0,70	206 BSA 101
C 2010 SS 	2	Alpolen® 1000 - Siyah / Black							0,70	206 BSA 102
C 2010 ZN 	2	Alpolen® 1000 - Yeşil / Green							0,70	206 BSA 201
C 2010 ZN 	2	Alpolen® 1000 - Siyah / Black							0,70	206 BSA 202
	2	Alpolen® 1000 - Yeşil / Green							0,19	206 BSA 001
	2	Alpolen® 1000 - Siyah / Black							0,19	206 BSA 002
Stainless Steel L: Standart Uzunluk (metre)/Standart Length (meter)										

ALPOLEN® 1000 KANALLI T MODEL ZİNCİR KIZAKLARI/ROLLER CHAIN GUIDES

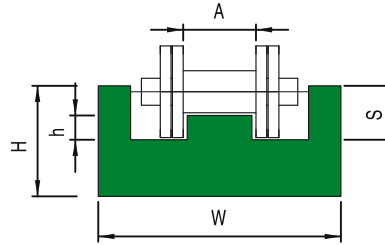

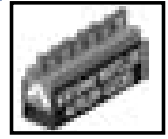
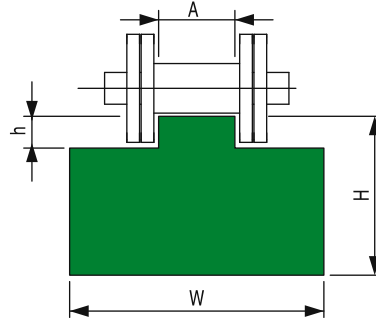
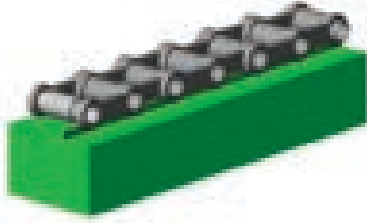

L: Standart Uzunluk/Standart Length (metre/meter)											
ISO			Hatve Pitch	W	H	A	h	S	L	Kg/m	Stok Kod Stock Code
06 B1	Alpolen® 1000 Yeşil / Green		3/8"	25	10	5,5	1,5	4,4	2	0,170	207 OT2 038
08 B1			1/2"	30	15	7,5	2,2	7,2	2	0,275	207 OT2 012
10 B1			5/8"	33	20	9,3	2,6	9,5	2	0,405	207 OT2 058
12 B1			3/4"	38	20	11,3	2,6	11,1	2	0,410	207 OT2 034
16 B1			1"	51	25	16,5	4,2	16,5	2	0,510	207 OT2 100
20 B1			1 1/4"	56	30	19	4,2	20,7	2	0,720	207 OT2 114

*Özel üretim yapılır./On request special production is available.

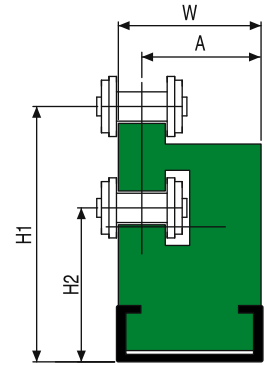
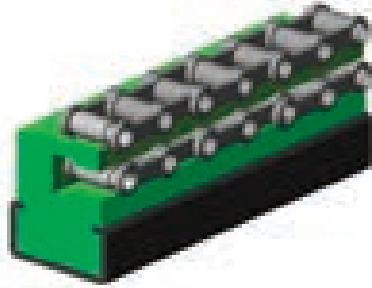

ALPOLEN® 1000 T MODEL ZİNCİR KIZAKLARI/ROLLER CHAIN GUIDES

L: Standart Uzunluk/Standart Length (metre/meter)									
ISO		Hatve Pitch	W	H	A	h	L	Kg/m	Stok Kod Stock Code
06 B1	Alpolen® 1000 Yeşil / Green	3/8"	15	10	5,5	1,5	2	0,135	207 OTO 038
08 B1		1/2"	20	10	7,5	2,2	2	0,165	207 OTO 012
08 B1		1/2"	20	15	7,5	2,2	2	0,265	207 OTO 112
10 B1		5/8"	20	10	9,3	2,6	2	0,160	207 OTO 058
10 B1		5/8"	20	15	9,3	2,6	2	0,260	207 OTO 158
12 B1		3/4"	25	10	11,3	2,6	2	0,210	207 OTO 034
12 B1		3/4"	25	15	11,3	2,6	2	0,325	207 OTO 134
16 B1		1"	40	15	16,5	4,2	2	0,470	207 OTO 100
16 B1		1"	40	20	16,5	4,2	2	0,660	207 OTO 101
20 B1		1 1/4"	45	15	19,0	4,2	2	0,530	207 OTO 114
20 B1		1 1/4"	45	20	19,0	4,2	2	0,720	207 OTO 214
24 B1		1 1/2"	60	15	24	5,5	2	0,785	207 OTO 412
28 B1		1 3/4"	75	20	30,1	6,8	2	1,130	207 OTO 434
32 B1		2"	85	20	30,1	7,7	2	1,210	207 OTO 200

ALPOLEN® 1000 TT MODEL TİPİ ZİNCİR KIZAKLARI/ROLLER CHAIN GUIDES

ISO	Hatve Pitch		W	H1	H2	A	 Kılavuz Guide	L	Kg/m	Stok Kod Stock Code
06 B1	3/8"	Alpolen® 1000 Yeşil / Green	20	30	17	14,5	C 2010 ZN	2	0,900	207 1TT C38
06 B1	3/8"		20	30	17	14,5	C 2010 SS	2	0,900	207 1TT P38
08 B1	1/2"		20	33,8	18	16,5	C 2010 ZN	2	0,960	207 1TT C12
08 B1	1/2"		20	33,8	18	16,5	C 2010 SS	2	0,960	207 1TT P12
10 B1	5/8"		20	41	21	15,5	C 2010 ZN	2	1,120	207 1TT C58
10 B1	5/8"		20	41	21	15,5	C 2010 SS	2	1,120	207 1TT P58
12 B1	3/4"		28	46,5	24	18,6	C 2812 ZN	2	1,700	207 1TT C34
12 B1	3/4"		28	46,5	24	18,6	C 2812 SS	2	1,700	207 1TT P34
16 B1	1"		38	62	34	25	C 3818 ZN	2	3,100	207 1TT C01
16 B1	1"		38	62	34	25	C 3818 SS	2	3,100	207 1TT P01

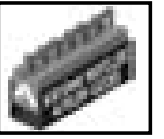
*Özel üretim yapılır./On request special production is available.



ALPOLEN® 1000 2T MODEL HAFİF TİP ZİNCİR KIZAKLARI/ROLLER CHAIN GUIDES (LIGHT TYPE)

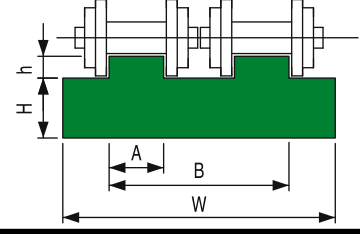
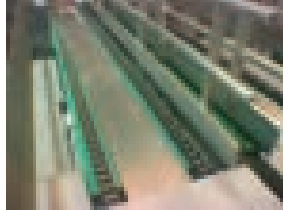
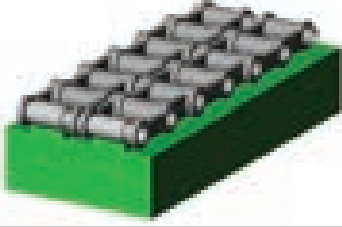

L: Standart Uzunluk/Standart Length (metre/meter)

ISO	Tip/Type		Hatve/Pitch	W	H	A	h	B	Kg/m	L	Stok Kod Stock Code
06 B2	Hafif Tip Light Type	Alpolen® 1000 Yeşil / Green	3/8"	25	10	5,4	1,5	15,7	0,230	2	207 TH2 510
08 B2			1/2"	35	10	7,4	2,2	21,4	0,306	2	207 TH3 510
10 B2			5/8"	40	10	9,2	2,6	25,8	0,344	2	207 TH4 010
10 B2			5/8"	40	15	9,2	2,6	25,8	0,524	2	207 TH4 015
12 B2			3/4"	45	10	11,3	2,6	30,6	0,396	2	207 TH4 510
12 B2			3/4"	45	15	11,3	2,6	30,6	0,598	2	207 TH4 515

ALPOLEN® 1000 2T MODEL AĞIR TİP ZİNCİR KIZAKLARI/ROLLER CHAIN GUIDES (HEAVY TYPE)

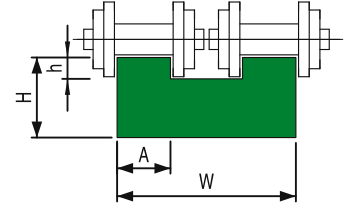
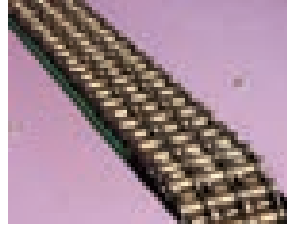

L: Standart Uzunluk/Standart Length (metre/meter)

ISO	Tip/Type		Hatve/Pitch	W	H	A	h	B	Kg/m	L	Stok Kod Stock Code
16 B2	Ağır Tip Heavy Type	Alpolen® 1000 Yeşil / Green	1"	48	15	16,5	4,2	-	0,863	2	207 TA4 815
16 B2			1"	48	20	16,5	4,2	-	1,156	2	207 TA4 820
20 B2			1 1/4"	55	15	19	4,2	-	0,912	2	207 TA5 515
20 B2			1 1/4"	55	20	19	4,2	-	1,232	2	207 TA5 520
24 B2			1 1/2"	72	20	24,6	5,5	-	1,499	2	207 TA7 220
28 B2			1 3/4"	89	20	30	6,8	-	1,790	2	207 TA8 920
32 B2			2"	89	20	30	7,7	-	1,750	2	207 TA8 921

"TT" ZİNCİR KIZAKLARI/"TT" ROLLER CHAIN GUIDES

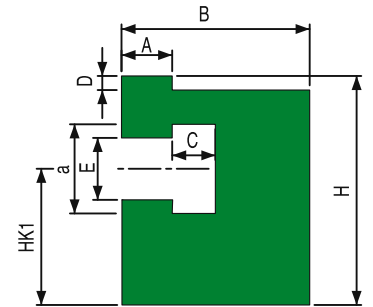
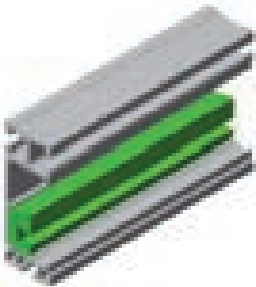

Profil Bölümü/Profiles: "TT"

	Hatve Pitch	a	A	C	D	E	B	H	HK1	Stok Kod Stock Code
Alpolen® 1000 Yeşil / Green	3/8"	9,5	5,4	4,5	1,5	6,6	20,0	24,4	14,5	207 0TT 001
	1/2"	13,0	7,4	4,5	2,2	8,6	20,0	26,9	15,5	207 0TT 002
	5/8"	15,5	9,2	5,6	2,6	10,4	20,0	33,8	18,5	207 0TT 003
	3/4"	17,0	11,3	6,4	2,6	12,2	28,0	37,3	21,5	207 0TT 004
	1/1"	22,0	16,5	10,5	2,9	16,0	38,0	50,5	31,5	207 0TT 005

L: Standart Uzunluk (metre)/Standart Length (meter)

*Özel üretim yapılır./On request special production is available.

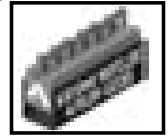
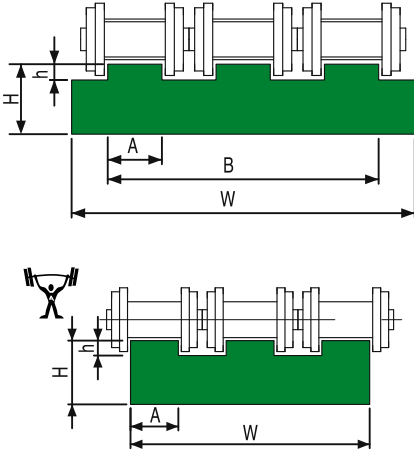
ALPOLEN® 1000 3 SIRALI ZİNCİR KIZAKLARI/ROLLER CHAIN GUIDES (TRIPLE)

Profil Bölümü:"3T"										
ISO		Hatve Pitch	W	H	A	h	B	L	Kg/m	Stok Kod Stock Code
06 B3	Alpolen® 1000 Yeşil/Green	3/8"	35	10	5,3	1,5	25,9	2	0,306	207 B33 510
08 B3		1/2"	45	10	7,1	2,2	35,3	2	0,381	207 B34 510
08 B3		1/2"	45	15	7,1	2,2	35,3	2	0,595	207 B34 515
08 B3		1/2"	45	20	7,1	2,2	35,3	2	0,808	207 B34 520
10 B3		5/8"	55	10	8,9	2,6	42,5	2	0,455	207 B35 510
12 B3		3/4"	60	15	10,7	2,4	50,3	2	0,546	207 B36 510
16 B3	1"	79,5	20	15,7	3,5	80,3	2	1,167	207 B39 515	
20 B3	Alpolen® 1000 Yeşil/Green	1 1/4"	91	20	18,0	4,3	91	2	1,304	207 B39 215
24 B3		1 1/2"	120	25	23,4	5,6	120	2	2,247	207 B31 120
28 B3		1 3/4"	149	25	30	6,9	149	2	3,522	207 B31 925
32 B3		2"	149	30	30	7,8	149	2	4,262	207 B31 930

L: Standart Uzunluk (metre)/Standart Length (meter)

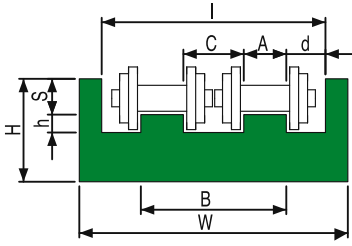
ALPOLEN® 1000 "UCD" ZİNCİR KIZAKLARI/ROLLER CHAIN GUIDES "UCD"

Profil Bölümü:"UCD"														
ISO		Hatve Pitch	W	H	I	h	A	S	B	C	d	L	Kg/m	Stok Kod Stock Code
06 B2	Alpolen® 1000 Yeşil/Green	3/8"	36	15	26	1,5	5,4	4,4	15,7	4,7	5	2	0,390	207 UCD 036
08 B2		1/2"	45	20	35	2,2	7,4	7,2	21,4	6,4	7	2	0,620	207 UCD 045
10 B2		5/8"	50	25	40	2,6	9,2	9,5	25,8	7,2	7	2	0,816	207 UCD 050
12 B2		3/4"	56	25	46	2,4	11,3	11,1	30,6	8	7,5	2	0,810	207 UCD 056
16 B2		1"	85	30	75	3,5	16,5	16,5	48	15	13,3	2	1,200	207 UCD 085

L: Standart Uzunluk (metre)/Standart Length (meter)

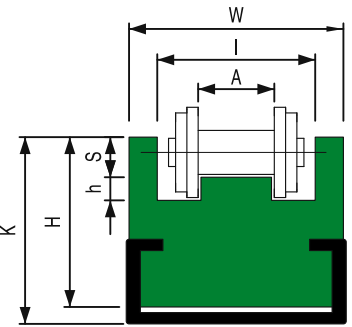
ALPOLEN® 1000 "UCC" ZİNCİR KIZAKLARI/ROLLER CHAIN GUIDES "UCC"

Profil Bölümü:"UCC"													
ISO		Hatve Pitch	Kılavuz Guide	W	H	K	I	h	A	S	L	Kg/m	Stok Kod Stock Code
06 B1	Alpolen® 1000 Yeşil/Green	3/8"	C 2010 ZN	20	15	17	13	1,5	3,8	1,1	2	0,760	207 UCC C25
06 B1		3/8"	C 2010 SS	20	15	17	13	1,5	3,8	1,1	2	0,760	207 UCC P25
08 B1		1/2"	C 2812 ZN	25	15	20	16	2,2	5,7	1,4	2	1,100	207 UCC C30
08 B1		1/2"	C 2812 SS	25	15	20	16	2,2	5,7	1,4	2	1,100	207 UCC P30
10 B1		5/8"	C 2812 ZN	28	15	20	9	2,6	7,4	2,1	2	1,305	207 UCC C33
10 B1		5/8"	C 2812 SS	28	15	20	9	2,6	7,4	2,1	2	1,305	207 UCC P33
12 B1		3/4"	C 3818 ZN	30	18	22	22	2,4	9,2	2,8	2	2,335	207 UCC C38
12 B1		3/4"	C 3818 SS	30	18	22	22	2,4	9,2	2,8	2	2,335	207 UCC P38
16 B1		1"	C 3818 ZN	42	25	30	35	3,5	15	3,3	2	2,440	207 UCC C51
16 B1		1"	C 3818 SS	42	25	30	35	3,5	15	3,3	2	2,440	207 UCC P51

L: Standart Uzunluk (metre)/Standart Length (meter)

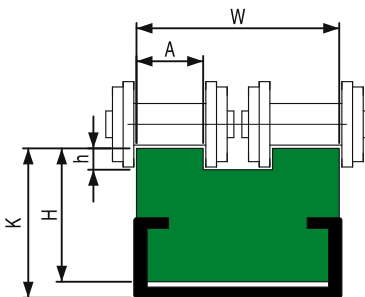
ALPOLEN® 1000 "TCG" ZİNCİR KIZAKLARI/ROLLER CHAIN GUIDES "TCG"

Profil Bölümü:"UCC"											
ISO		Hatve Pitch	Kılavuz Guide	W	H	K	h	A	L	Kg/m	Stok Kod Stock Code
06 B2	Alpolen® 1000 Yeşil/Green	3/8"	C 2010 ZN	15,6	14	17	1,5	5,3	2	0,615	207 TCG C38
06 B2		3/8"	C 2010 SS	15,6	14	17	1,5	5,3	2	0,615	207 TCG P38
08 B2		1/2"	C 2010 ZN	21,2	14	17	2,2	7,2	2	0,715	207 TCG C12
08 B2		1/2"	C 2010 SS	21,2	14	17	2,2	7,2	2	0,715	207 TCG P12
10 B2		5/8"	C 2812 ZN	25,6	14	17	2,6	9	2	1,165	207 TCG C58
10 B2		5/8"	C 2812 SS	25,6	14	17	2,6	9	2	1,165	207 TCG P58
12 B2		3/4"	C 2812 ZN	30,4	15	20	2,4	10,9	2	1,200	207 TCG C34
12 B2		3/4"	C 2812 SS	30,4	15	20	2,4	10,9	2	1,200	207 TCG P34

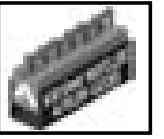

L: Standart Uzunluk (metre)/Standart Length (meter)

*Özel üretim yapılır./On request special production is available.



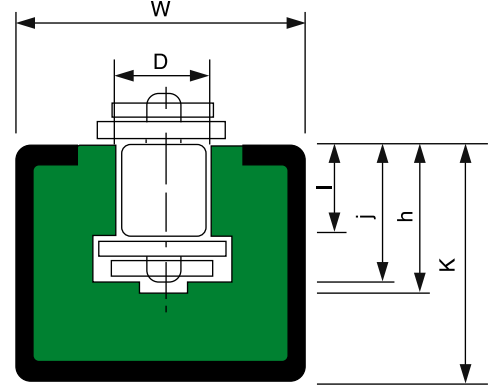
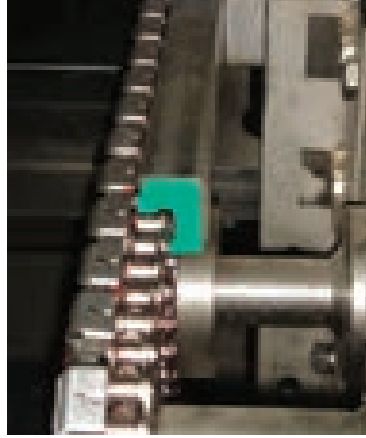
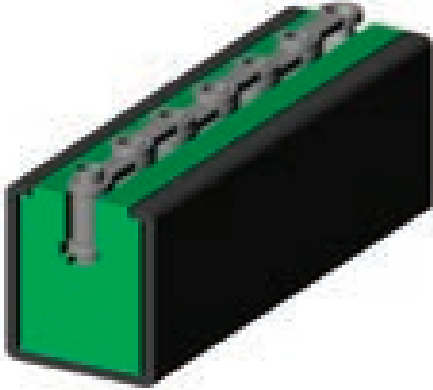

ALPOLEN® CCZ MODEL ÇELİK PROFİLLİ ZİNCİR KIZAKLARI/ROLLER CHAIN GUIDES



ISO	Hatve/Pitch		W	K	h	j	I	D		Kılavuz Guide	L	Kg/m	Stok Kod Stock Code
06 B	3/8"	Alpolen® 1000 Yeşil / Green	30	24	10,0	8,9	5,5	6,6		C3024 ZN	2	1,375	207 CCZ 038
06 B	3/8"		30	24	10,0	8,9	5,5	6,6		C3024 SS	2	1,375	207 CCZ 138
08 B	1/2"		30	24	12,7	11,5	7,5	8,7		C3024 ZN	2	1,350	207 CCZ 012
08 B	1/2"		30	24	12,7	11,5	7,5	8,7		C3024 SS	2	1,350	207 CCZ 112
10 B	5/8"		30	24	14,8	13,5	9,3	10,4		C3024 ZN	2	1,300	207 CCZ 058
10 B	5/8"		30	24	14,8	13,5	9,3	10,4		C3024 SS	2	1,300	207 CCZ 158
12 B	3/4"		30	24	17,5	15,9	11,3	12,3		C3024 ZN	2	1,260	207 CCZ 034
12 B	3/4"		30	24	17,5	15,9	11,3	12,3		C3024 SS	2	1,260	207 CCZ 134
16 B	1"		45	40	28,2	25,7	16,5	16,2		C4540 ZN	2	2,930	207 CCZ 100
16 B	1"		45	40	28,2	25,7	16,5	16,2		C4540 SS	2	2,930	207 CCZ 101

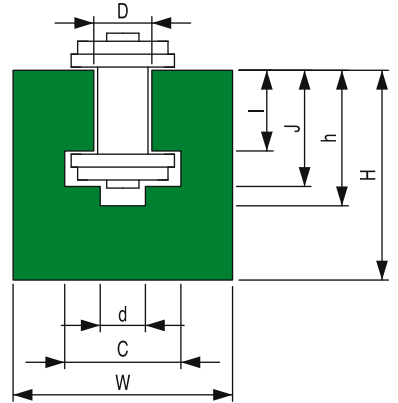
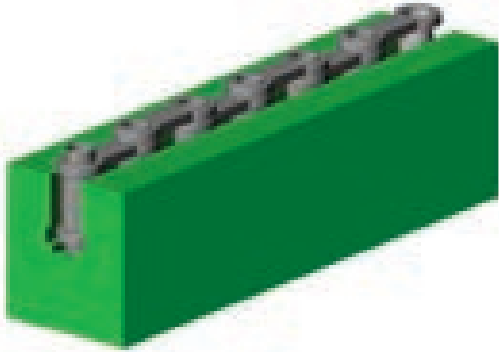

ALPOLEN® 1000 MODEL BL TİPİ ZİNCİR KIZAKLARI/ROLLER CHAIN GUIDES

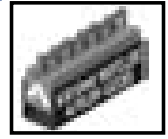
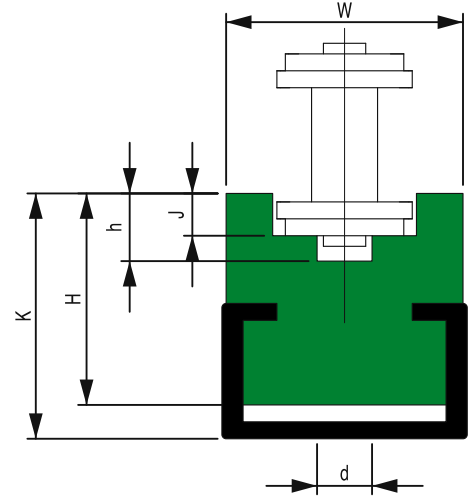
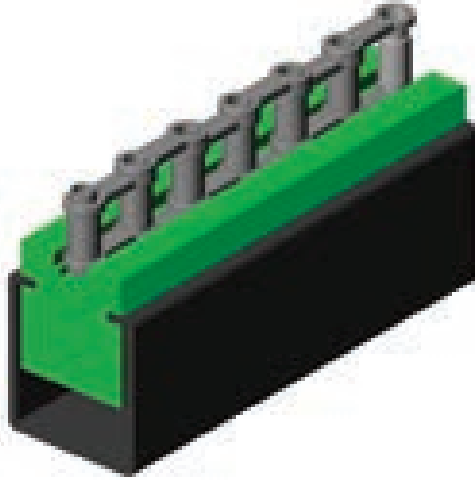

ISO	Hatve/Pitch		W	H	C	h	I	D	J	d	L	Kg/m	Stok Kod Stock Code
06 B	3/8"*7/32"	Alpolen® 1000 Yeşil / Green	20	20	9,2	10,0	5,5	6,6	8,9	3,7	2	0,414	207 BLO 038
08 B	1/2"*5/16"		24	24	12,7	12,7	7,5	8,7	11,5	4,9	2	0,564	207 BL1 012
10 B	5/8"*3/8"		30	30	15,2	14,8	9,3	10,4	13,5	5,6	2	0,832	207 BL2 058
12 B	3/4"*7/16"		40	40	16,7	17,5	11,3	12,3	15,9	6,6	2	1,106	207 BL3 034
16 B	1"*17mm		40	40	21,7	28,2	16,5	16,2	25,7	8,9	2	1,231	207 BL4 001
20 B	1 1/4"*3/4"		50	50	27,4	31,5	19	19,3	29,5	11	2	1,726	207 BL5 114
24 B	1 1/2"*1"		60	60	35	40,3	24,7	25,7	38,5	15,5	2	2,332	207 BL6 112
28 B	1 3/4"*31mm		70	60	39	49,2	31,1	28,3	47,3	17	2	3,173	207 BL7 134
32 B	2"*31mm		75	70	44	53,3	31,1	29,6	47,3	19	2	3,264	207 BL8 002

*Özel üretim yapılır./On request special production is available.

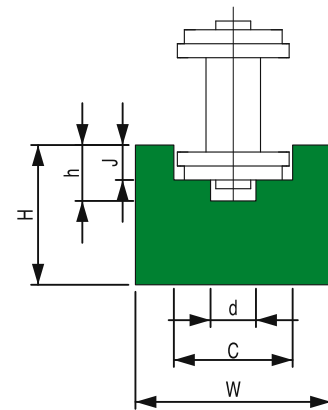
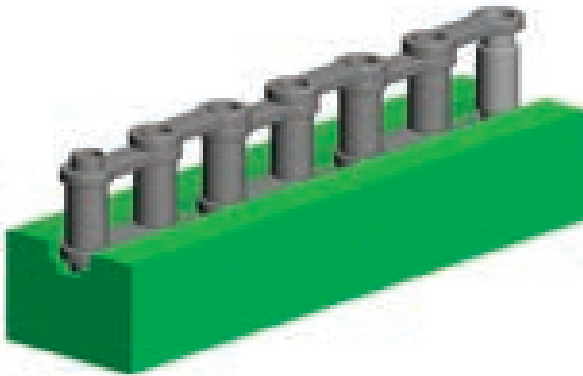

ALPOLEN® 1000 U MODEL ÇELİK PROFİLLİ ZİNCİR KIZAKLARI/ROLLER CHAIN GUIDES

L: Standart Uzunluk/Standart Length (metre/meter)													
ISO		Hatve/Pitch	W	H	K	h	J	d		Kılavuz Guide	L	Kg/m	Stok Kod Stock Code
06 B1	Alpolen® 1000 Yeşil / Green	3/8"	20	15	15	4,2	2,8	4		C 2010 ZN	2	0,720	207 CU0 038
06 B1		3/8"	20	15	15	4,2	2,8	4		C 2010 SS	2	0,720	207 CU0 138
08 B1		1/2"	25	15	22	4,8	3,5	5		C 2812 ZN	2	1,140	207 CU0 012
08 B1		1/2"	25	15	22	4,8	3,5	5		C 2812 SS	2	1,140	207 CU0 112
10 B1		5/8"	25	15	22	5,1	3,6	6		C 2812 ZN	2	1,130	207 CU0 058
10 B1		5/8"	25	15	22	5,1	3,6	6		C 2812 SS	2	1,130	207 CU0 158
12 B1		3/4"	25	20	27	5,7	3,9	7		C 2812 ZN	2	1,270	207 CU0 034
12 B1		3/4"	25	20	27	5,7	3,9	7		C 2812 SS	2	1,270	207 CU0 134
16 B1		1"	35	25	33	10	8,4	9		C 3818 ZN	2	2,030	207 CU0 100
16 B1		1"	35	25	33	10	8,4	9		C 3818 SS	2	2,030	207 CU0 101

ALPOLEN® 1000 U ZİNCİR KIZAKLARI/ROLLER CHAIN GUIDES

L: Standart Uzunluk/Standart Length (metre/meter)												
ISO		Hatve/Pitch	W	H	C	h	J	d	L	Kg/m	Stok Kod Stock Code	
06 B	Alpolen® 1000 Yeşil / Green	3/8"*7/32"	20	15	9,2	4,2	2,8	4	2	0,257	207 0U0 038	
08 B		1/2"*5/16"	25	15	12,7	4,8	3,5	5	2	0,308	207 0U1 012	
10 B		5/8"*3/8"	25	15	15,2	5,1	3,6	6	2	0,296	207 0U2 058	
12 B		3/4"*7/16"	25	20	16,7	5,7	3,9	7	2	0,430	207 0U3 034	
16 B		1"*17mm	35	25	22,2	10	8,4	9	2	0,624	207 0U4 001	

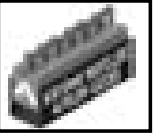
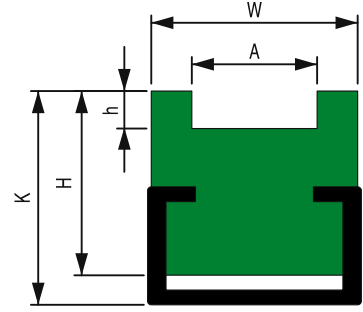
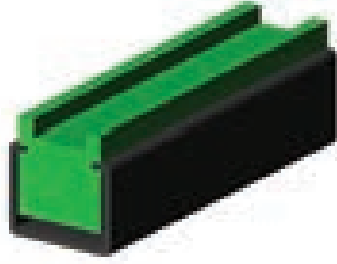
*Özel üretim yapılır./On request special production is available.

ALPOLEN® 1000 U DÜZ BANTLAR İÇİN ÇELİK PROFİLLİ ZİNCİR KIZAKLARI/STRAIGHT CHAIN GUIDES



K :

H :

h :

W :

A :

	 Kılavuz Guide	L	Kg/m	Stok Kod Stock Code
Alpolen® 1000 Yeşil / Green	ZN	2	-	207 TUO 001
	SS	2	-	207 TUO 002

*LÜTFEN ÖLÇÜLERİ DOLDURARAK TALEPTE BULUNUNUZ. / TO MAKE AN ORDER INDICATE DIMENSIONS

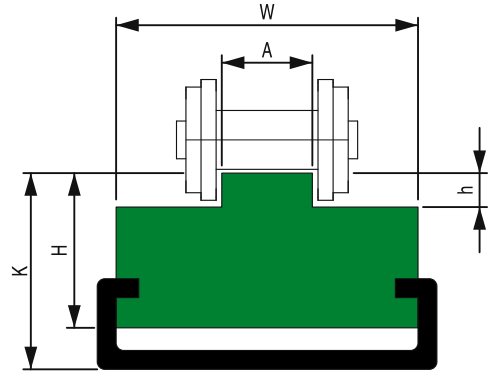
ALPOLEN® 1000 T MODEL ÇELİK PROFİLLİ ZİNCİR KIZAKLARI/ROLLER CHAIN GUIDES

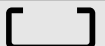
L: Standart Uzunluk/Standart Length (metre/meter)

ISO		Hatve/Pitch	W	H	K	h	A	 Kılavuz Guide	L	Kg/m	Stok Kod Stock Code
06 B1	Alpolen® 1000 Yeşil / Green	3/8"	17	15	17	1,5	5,4	C 2010 ZN	2	0,620	207 H15 038
06 B1		3/8"	17	15	17	1,5	5,4	C 2010 SS	2	0,620	207 H15 138
08 B1		1/2"	17	15	17	2,2	7,4	C 2010 ZN	2	0,695	207 H15 012
08 B1		1/2"	17	15	17	2,2	7,4	C 2010 SS	2	0,695	207 H15 112
10 B1		5/8"	17	15	17	2,6	9,2	C 2010 ZN	2	0,700	207 H15 058
10 B1		5/8"	17	15	17	2,6	9,2	C 2010 SS	2	0,700	207 H15 158
12 B1		3/4"	20	15	18	2,4	11,3	C 2812 ZN	2	1,170	207 H15 034
12 B1		3/4"	20	15	18	2,4	11,3	C 2812 SS	2	1,170	207 H15 134
16 B1		1"	24	20	24	3,5	16	C 2812 ZN	2	2,245	207 H20 100
16 B1		1"	24	20	24	3,5	16	C 2812 SS	2	2,245	207 H20 101
16 B1		1"	24	15	18	3,5	16	C 2812 ZN	2	1,250	207 H15 100
16 B1		1"	24	15	18	3,5	16	C 2812 SS	2	1,250	207 H15 101
20 B1		1 1/4"	28	25	18	4,3	18	C 3818 ZN	2	2,305	207 H25 114
20 B1		1 1/4"	28	25	18	4,3	18	C 3818 SS	2	2,305	207 H25 214
24 B1		1 1/2"	33	25	30	5,6	24	C 3818 ZN	2	2,390	207 H25 112
24 B1		1 1/2"	33	25	30	5,6	24	C 3818 SS	2	2,390	207 H25 212
28 B1		1 3/4"	38	25	30	6,9	30	C 3818 ZN	2	2,410	207 H25 134
28 B1		1 3/4"	38	25	30	6,9	30	C 3818 SS	2	2,410	207 H25 234
32 B1		2"	38	25	30	7,8	30	C 3818 ZN	2	2,480	207 H25 200
32 B1		2"	38	25	30	7,8	30	C 3818 SS	2	2,480	207 H25 201

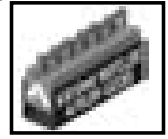
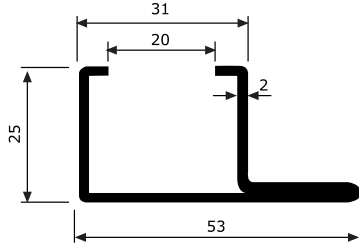
*Özel üretim yapılır./On request special production is available.



ALPOLEN® 1000 ZİNCİR KIZAKLARI/CHAIN GUIDES

Profil Bölümü/Profiles:"C"

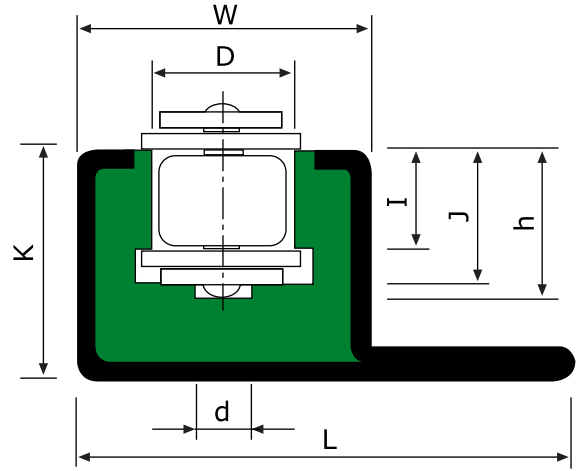
Kılavuz Guide	L	Kg/m	Stok Kod Stock Code
ZN	2	1,200	207 KDC 001
SS	2	1,200	207 KDP 002

L:Standart Uzunluk(metre)/Standart Length(meter)

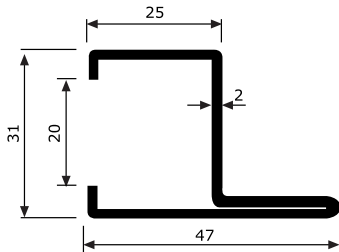

Hatve Pitch		W	K	L	I	J	h	d	D	Kılavuz Guide	L	Kg/m	Stok Kod Stock Code
3/8"	Alpolen® 1000 Yeşil / Green	31	25	53	5,6	8,7	10	4	6,6	ZN	2	2,340	207 YDC 038
3/8"	Alpolen® 1000 Yeşil / Green	31	25	53	5,6	8,7	10	4	6,6	SS	2	2,340	207 YDP 038
1/2"	Alpolen® 1000 Yeşil / Green	31	25	53	7,6	11,5	13	5	8,7	ZN	2	2,300	207 YDC 012
1/2"	Alpolen® 1000 Yeşil / Green	31	25	53	7,6	11,5	13	5	8,7	SS	2	2,300	207 YDP 012
5/8"	Alpolen® 1000 Yeşil / Green	31	25	53	9,3	13,5	14,5	6	10,4	ZN	2	2,250	207 YDC 058
5/8"	Alpolen® 1000 Yeşil / Green	31	25	53	9,3	13,5	14,5	6	10,4	SS	2	2,250	207 YDP 058
3/4"	Alpolen® 1000 Yeşil / Green	31	25	53	11,5	15,9	17,5	7	12,3	ZN	2	2,250	207 YDC 034
3/4"	Alpolen® 1000 Yeşil / Green	31	25	53	11,5	15,9	17,5	7	12,3	SS	2	2,250	207 YDP 034

ALPOLEN® 1000 ZİNCİR KIZAKLARI/CHAIN GUIDES

Profil Bölümü/Profiles:"C"

Kılavuz Guide	L	Kg/m	Stok Kod Stock Code
ZN	2	1,200	207 KDC 003
SS	2	1,200	207 KDP 004

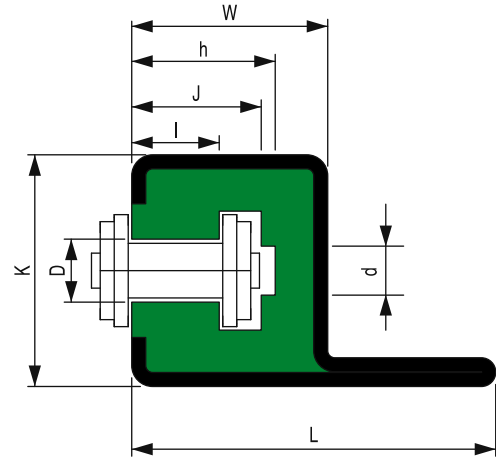

L:Standart Uzunluk(metre)/Standart Length(meter)





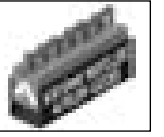
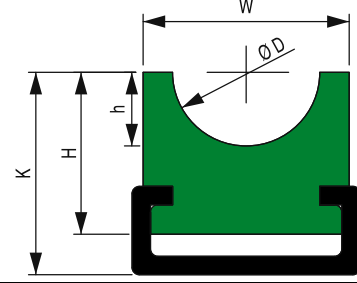

Hatve Pitch		W	K	L	I	J	h	d	D	Kılavuz Guide	L	Kg/m	Stok Kod Stock Code
3/8"	Alpolen® 1000 Yeşil / Green	25	31	47	5,6	8,7	10	4	6,6	ZN	2	2,150	207 DYC 038
3/8"	Alpolen® 1000 Yeşil / Green	25	31	47	5,6	8,7	10	4	6,6	SS	2	2,150	207 DYP 038
1/2"	Alpolen® 1000 Yeşil / Green	25	31	47	7,6	11,5	13	5	8,7	ZN	2	2,150	207 DYC 012
1/2"	Alpolen® 1000 Yeşil / Green	25	31	47	7,6	11,5	13	5	8,7	SS	2	2,150	207 DYP 012
5/8"	Alpolen® 1000 Yeşil / Green	25	31	47	9,3	13,5	14,5	6	10,4	ZN	2	2,100	207 DYC 058
5/8"	Alpolen® 1000 Yeşil / Green	25	31	47	9,3	13,5	14,5	6	10,4	SS	2	2,100	207 DYP 058
3/4"	Alpolen® 1000 Yeşil / Green	25	31	47	11,5	15,9	17,5	7	12,3	ZN	2	2,060	207 DYC 034
3/4"	Alpolen® 1000 Yeşil / Green	25	31	47	11,5	15,9	17,5	7	12,3	SS	2	2,060	207 DYP 034

*Özel üretim yapılır./On request special production is available.

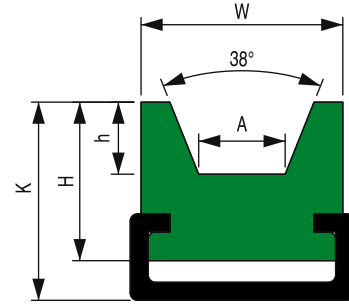
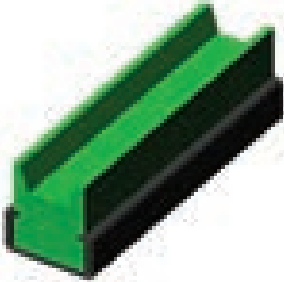

ALPOLEN® 1000 ÇELİK PROFİLLİ KAYIŞ KILAVUZLARI / CABLE AND BELT GUIDES

L: Standart Uzunluk/Standart Length (metre/meter)

	Kayış Tipi Chain Type	W	H	h	K	D	 Kılavuz Guide	L	Kg/m	Stok Kod Stock Code
Alpolen® 1000 Yeşil / Green	Ø4	20	10	2	14	4	C 2010 ZN	2	0,680	207 CC0 004
	Ø4	20	10	2	14	4	C 2010 SS	2	0,680	207 CP0 004
	Ø5	20	10	2,5	14	5	C 2010 ZN	2	0,675	207 CC0 005
	Ø5	20	10	2,5	14	5	C 2010 SS	2	0,675	207 CP0 005
	Ø5	20	10	3	14	6	C 2010 ZN	2	0,660	207 CC0 105
	Ø5	20	10	3	14	6	C 2010 SS	2	0,660	207 CP0 105
	Ø6,3	20	10	4	18	8	C 2010 ZN	2	0,650	207 CC0 006
	Ø6,3	20	10	4	18	8	C 2010 SS	2	0,650	207 CP0 006
	Ø8	20	15	5	18	10	C 2812 ZN	2	1,179	207 CC0 008
	Ø8	20	15	5	18	10	C 2812 SS	2	1,179	207 CP0 008
	Ø9,5	25	15	6	20	12	C 2812 ZN	2	1,140	207 CC0 009
	Ø9,5	25	15	6	20	12	C 2812 SS	2	1,140	207 CP0 009
	Ø12,5	28	15	8	20	14	C 2812 ZN	2	1,160	207 CC0 012
	Ø12,5	28	15	8	20	14	C 2812 SS	2	1,160	207 CP0 012
	Ø15	33	25	10	25	18	C 2812 ZN	2	1,213	207 CC0 015
	Ø15	33	25	10	25	18	C 2812 SS	2	1,213	207 CP0 015
	Ø18	38	20	12	25	20	C 2812 ZN	2	1,280	207 CC0 018
	Ø18	38	20	12	25	20	C 2812 SS	2	1,280	207 CP0 018

ALPOLEN® 1000 ÇELİK PROFİLLİ "V" KAYIŞ KILAVUZLARI / "V"-BELT GUIDES

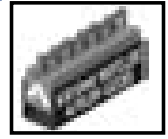
L: Standart Uzunluk/Standart Length (metre/meter)

	W	H	h	K	A	 Kılavuz Guide		L	Kg/m	Stok Kod Stock Code
Alpolen® 1000 Yeşil / Green	20	10	3,5	15	6	C 2010 ZN	8x5	2	0,787	207 VC0 004
	20	10	3,5	15	6	C 2010 SS	8x5	2	0,787	207 VP0 004
	20	15	4,5	18	7,2	C 2010 ZN	10x6	2	0,782	207 VC0 005
	20	15	4,5	18	7,2	C 2010 SS	10x6	2	0,782	207 VP0 005
	25	18	6	22	9,2	C 2812 ZN	13x8	2	1,352	207 VC0 006
	25	18	6	22	9,2	C 2812 SS	13x8	2	1,352	207 VP0 006
	30	18	8	24	11,5	C 2812 ZN	17x11	2	1,439	207 VC0 008
	30	18	8	24	11,5	C 2812 SS	17x11	2	1,439	207 VP0 008
	30	18	9	24	14,5	C 3818 ZN	22x14	2	2,265	207 VC0 010
	30	18	9	24	14,5	C 3818 SS	22x14	2	2,265	207 VP0 010
	60	35	16	40	21	C 3818 ZN	32x20	2	2,574	207 VC0 012
	60	35	16	40	21	C 3818 SS	32x20	2	2,574	207 VP0 012

*Özel üretim yapılır./On request special production is available.

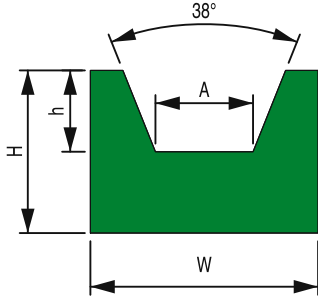

ALPOLEN® 1000 "V" KAYIŞ KIZAKLARI/"V" BELT GUIDES



Profil Bölümü/ Profiles:"CTV"								
M	W	H	h	A		L	Kg/m	Stok Kod Stock Code
Alpolen® 1000 Yeşil/Green	20	10	3,5	6	8x5	2	0,197	207 CTV 020
	20	10	4	7,2	10x6	2	0,232	207 CTV 120
	20	12	6	9,2	13x8	2	0,292	207 CTV 220
	30	15	8	11,5	17x11	2	0,429	207 CTV 030
	35	20	10,5	14,5	22x14	2	0,660	207 CTV 035
	40	25	12	16,5	25x16	2	0,944	207 CTV 040
	50	30	16	21	32x20	2	1,054	207 CTV 050

L: Standart Uzunluk (metre)/Standart Length (meter)

ALPOLEN® 1000 "CTO" KAYIŞ KIZAKLARI/"CTO" BELT GUIDES

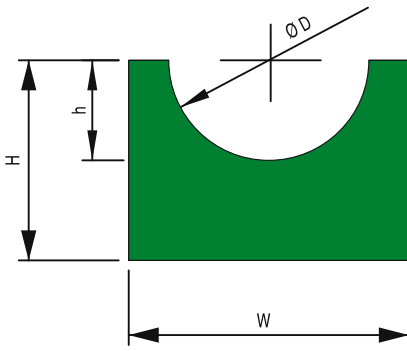

Profil Bölümü/ Profiles:"CTO"								
M	Bant Tipi Belt Type	W	H	h	ØD	L	Kg/m	Stok Kod Stock Code
Alpolen® 1000 Yeşil/Green	Ø4	15	10	2	4	2	0,144	207 CTO 015
	Ø4	15	10	2,5	5	2	0,140	207 CTO 115
	Ø5	20	10	3	6	2	0,186	207 CTO 020
	Ø6,3	20	10	4	8	2	0,175	207 CTO 120
	Ø8	20	12	5	10	2	0,260	207 CTO 220
	Ø9,5	25	15	6	12	2	0,244	207 CTO 125
	Ø12,5	28	20	8	14	2	0,286	207 CTO 028
	Ø15	33	25	10	18	2	0,325	207 CTO 033
	Ø18	38	25	12	20	2	0,442	207 CTO 038

L: Standart Uzunluk (metre)/Standart Length (meter)

ALPOLEN® 1000 "YD1" KAYIŞ KIZAKLARI/BELT GUIDES "YD1"

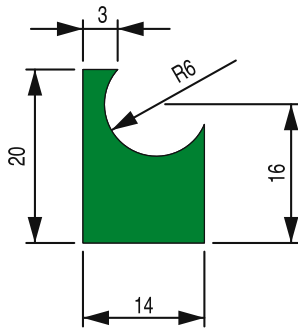

Profil Bölümü/Profiles:"YD1"			
Malzeme/Material	L	Kg/m	Stok Kod/Stock Code
Alpolen® 1000 Yeşil/Green	2	0,18	207 CY1 001

L: Standart Uzunluk (metre)/Standart Length (meter)

ALPOLEN® 1000 "YD2" KAYIŞ KIZAKLARI/BELT GUIDES "YD2"

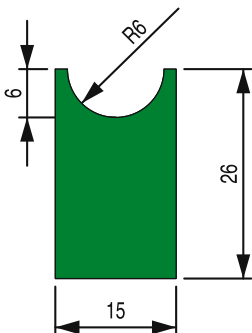

Profil Bölümü/Profiles:"YD2"			
M	L	Kg/m	Stok Kod/Stock Code
Alpolen® 1000 Yeşil/Green	2	0,34	207 CY1 002

L: Standart Uzunluk (metre)/Standart Length (meter)

*Özel üretim yapılır./On request special production is available.

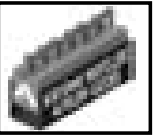

UYGULAMALAR/APPLICATIONS

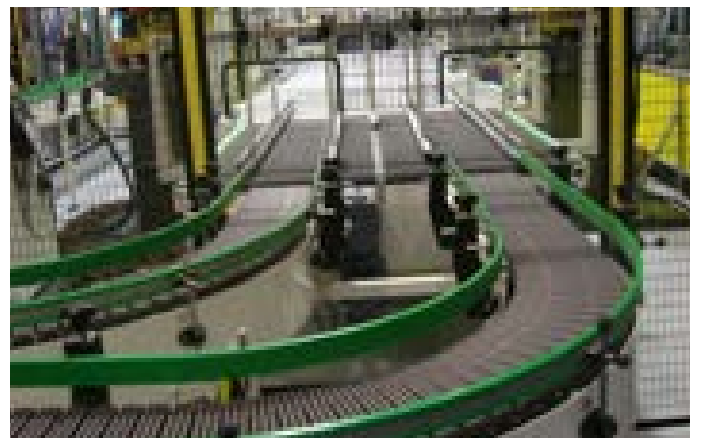
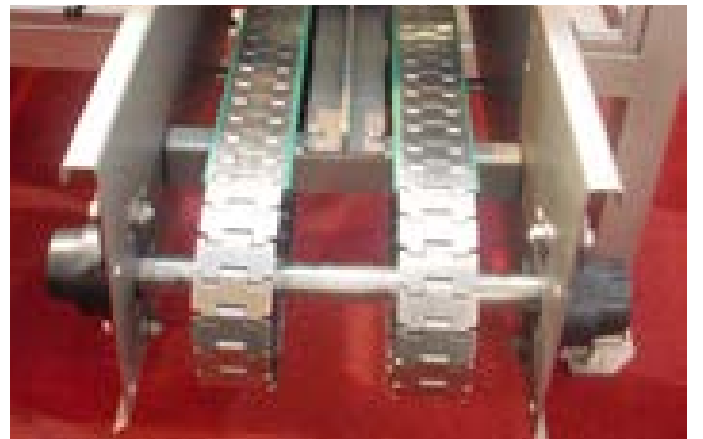
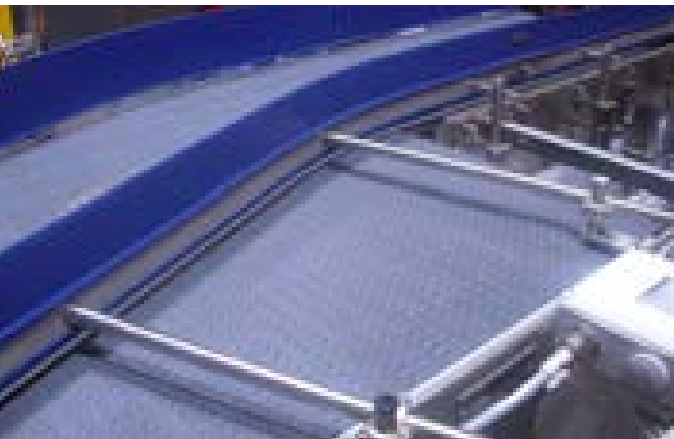
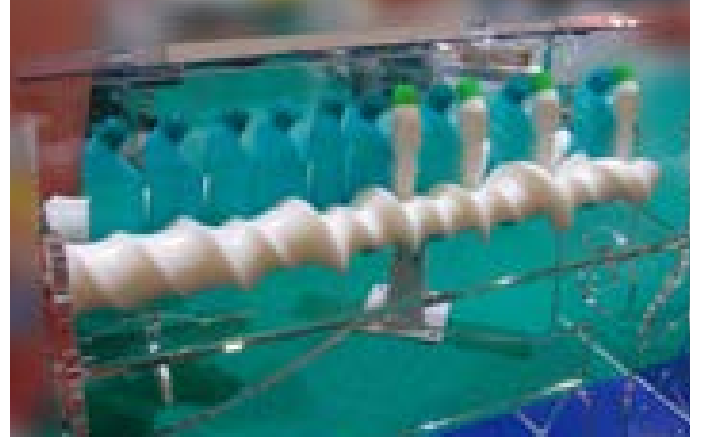

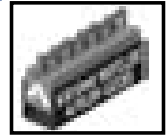

ÖZEL PROFİL UYGULAMALARI/SPECIAL PROFILES APPLICATIONS

Malzeme/Material: ALPOLEN®

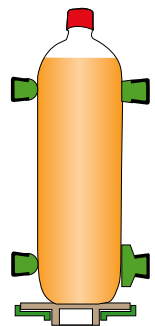
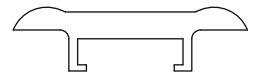
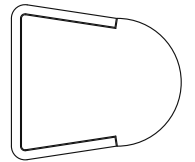
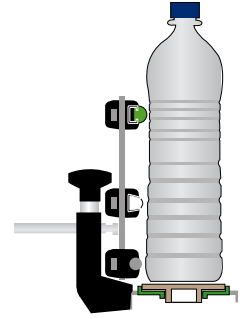
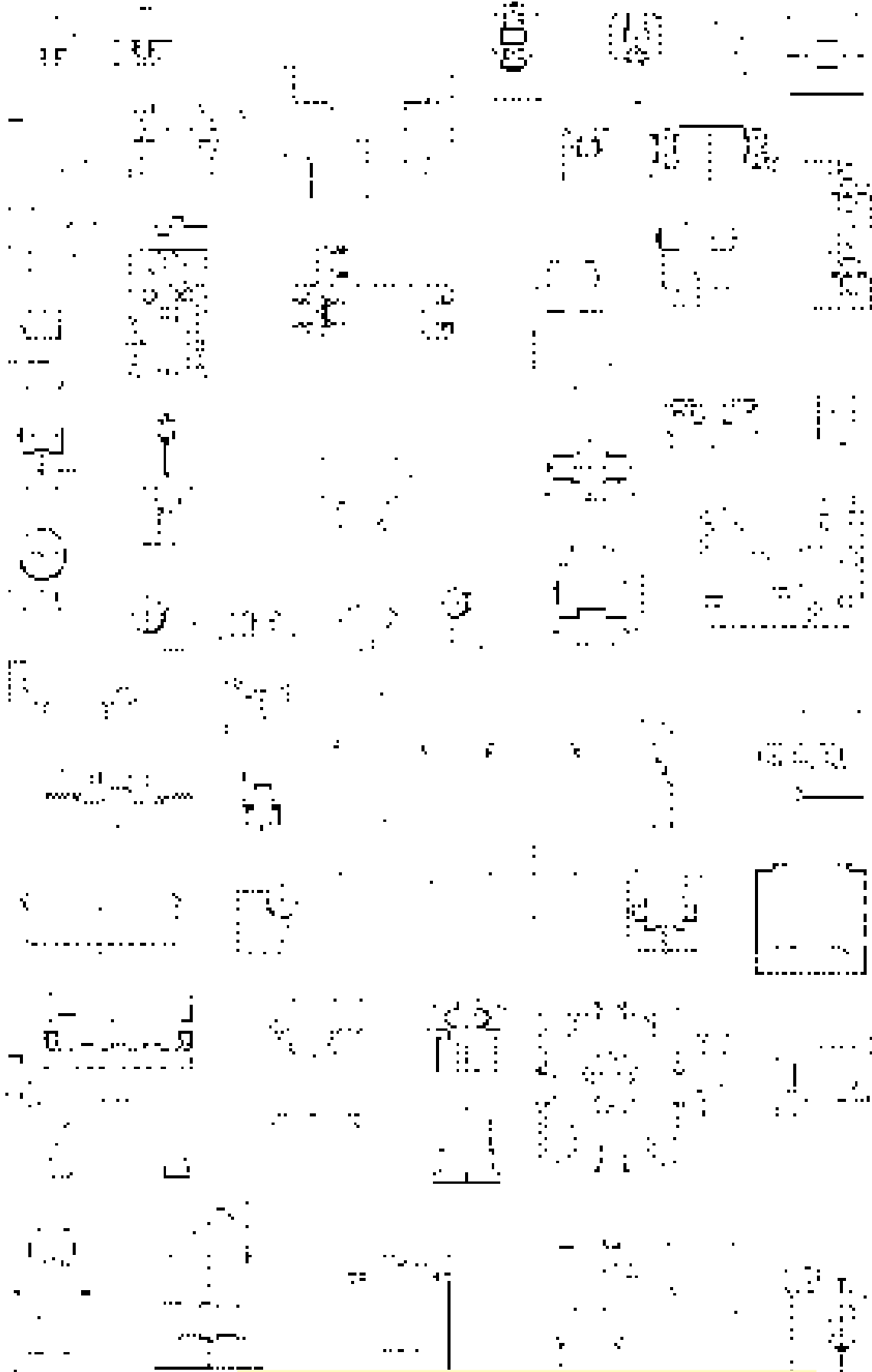

*Özel üretim yapılır./On request special production is available.

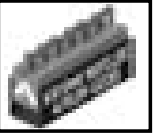

ÖZEL PROFİL UYGULAMALARI/SPECIAL PROFILES APPLICATIONS

M ALPOLEN® UHMW 1000  6-60 m

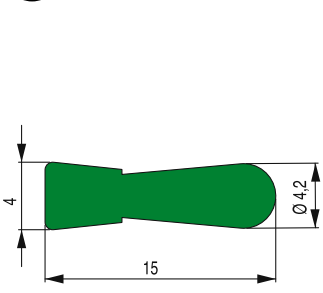

206 RGL 232

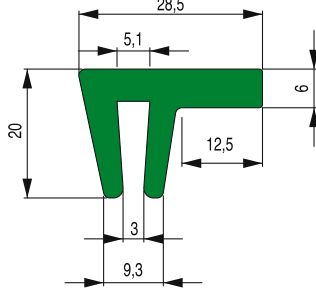

206 GZU 221

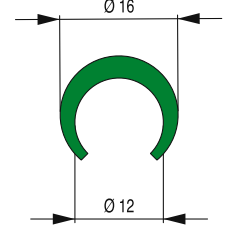

206 RGU 415

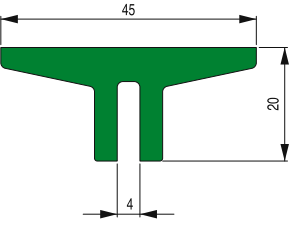

206 RGU 088

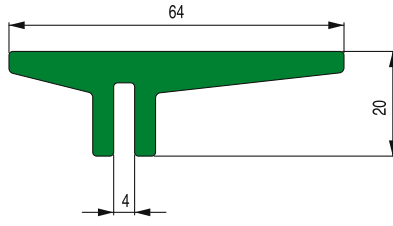

206 RGD 089

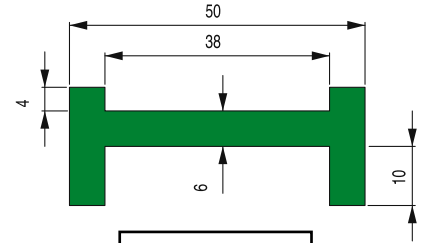

206 GZU 076

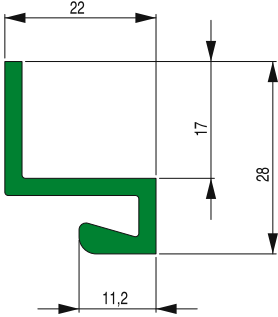

206 OGL 108

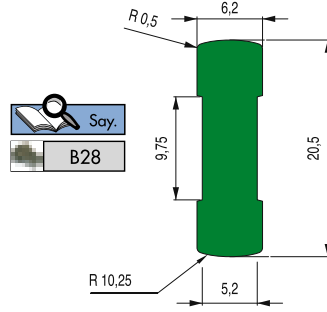

216 100 104

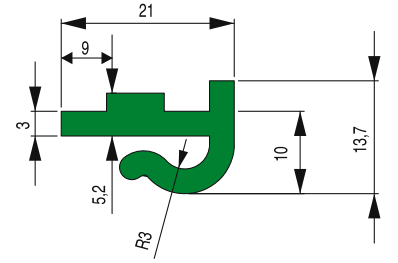

206 GLA 266

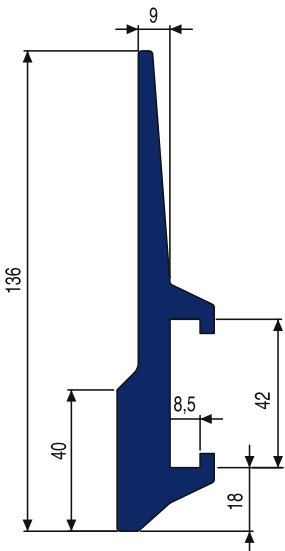

206 RGC 330

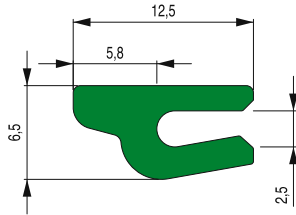

206 RGC 352

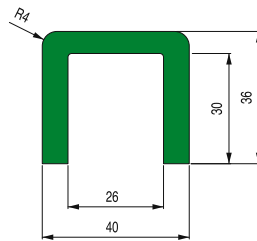

206 GZU 026

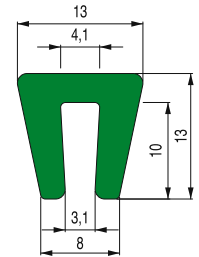

206 RGU 219

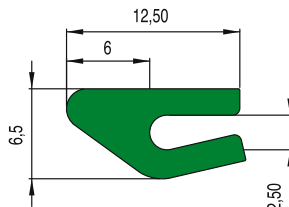

206 RGB 351

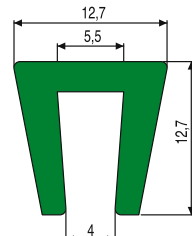

206 RGU 413

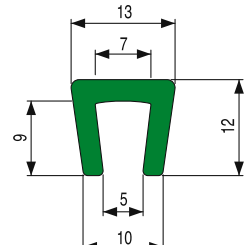

206 RGU 023

*Özel üretim yapılır./On request special production is available.

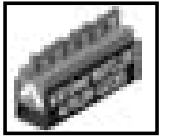

ÖZEL PROFİL UYGULAMALARI/SPECIAL PROFILES APPLICATIONS

	Say.
*	E20
	B3



206 RGC 330

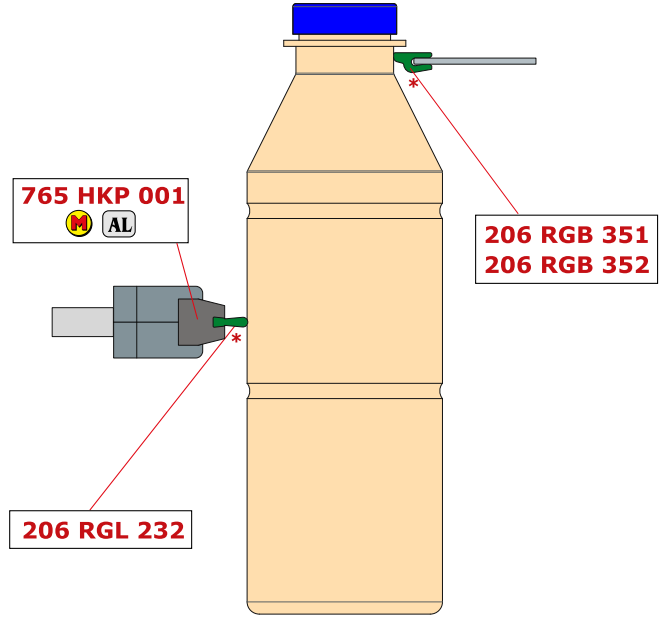

206 RGU 413

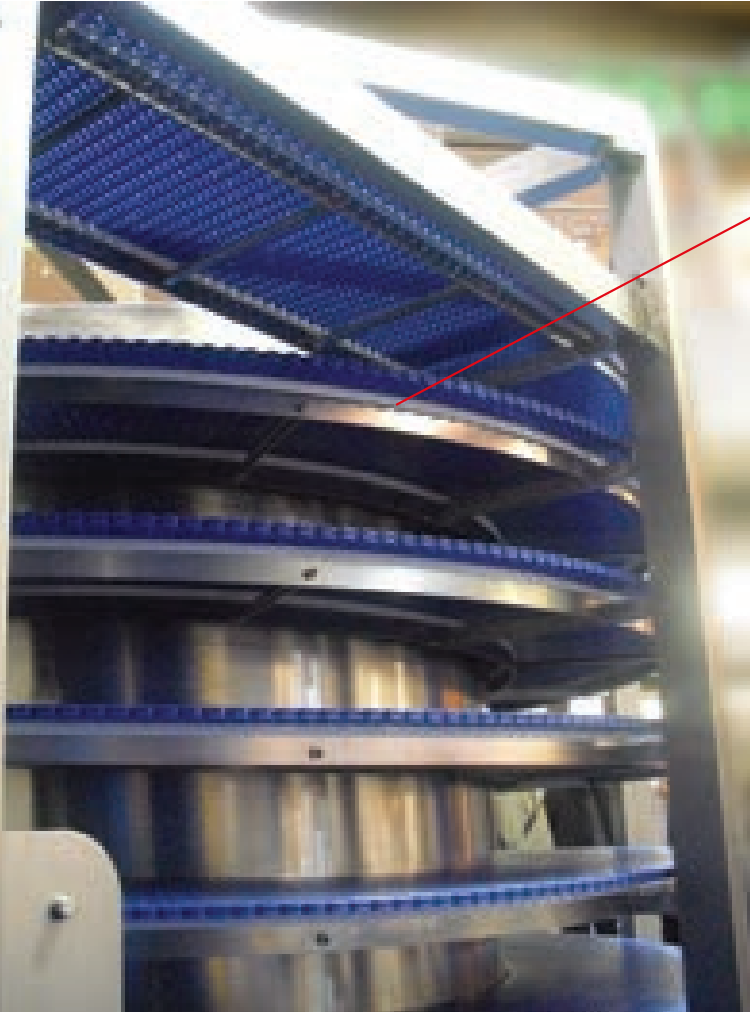

	Say.
	D37



*Özel üretim yapılır./On request special production is available.

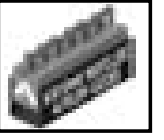

ÇELİK PROFİLLER/STEEL PROFILES

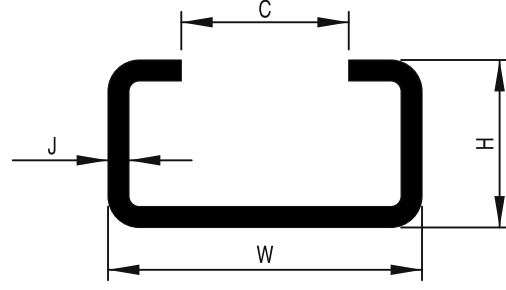

Profil Bölümü/Profiles: "C"							
Profil/Guide	W	H	C	J	L	Kg/m	Stok Kod Stock Code
C 20/10 ZN	20	10	10	1,5	2	0,490	206 C02 010
C 20/10 SS	20	10	10	1,5	2	0,490	206 P02 010
C 28/12 ZN	28	12	14	2	2	0,860	206 C02 812
C 28/12 SS	28	12	14	2	2	0,860	206 P02 812
C 38/18 ZN	38	18	22	2,5	2	1,430	206 C03 818
C 38/18 SS	38	18	22	2,5	2	1,430	206 P03 818
C 30/24 ZN	30	24	20	1,5	2	0,940	206 C03 024
C 30/24 SS	30	24	20	1,5	2	0,940	206 P03 024
C 45/40 ZN	45	40	31	2	2	2,050	206 C04 540
C 45/40 SS	45	40	31	2	2	2,050	206 P04 540

L: Standart Uzunluk (metre)/Standart Length (meter)

ÇELİK PROFİLLER/STEEL PROFILES

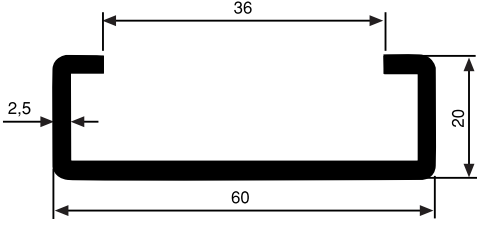

M SS ZN

Profil Bölümü/Profiles: "C"			
Profil/Guide	L	Kg/m	Stok Kod Stock Code
ZN	2	2,160	206 C06 020
SS	2	2,160	206 P06 020

L:Standart Uzunluk(metre)/Standart Length(meter)

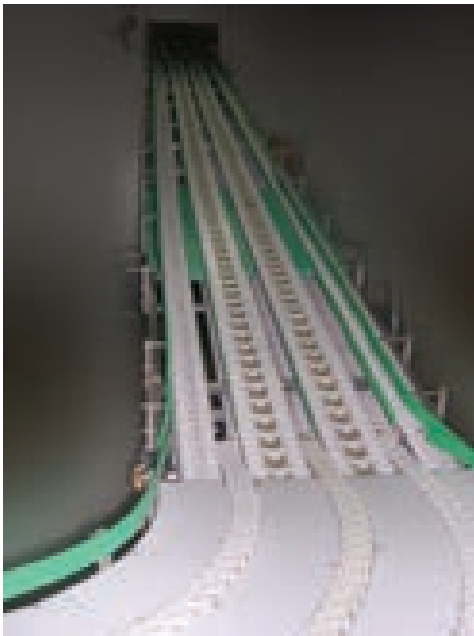

*Özel üretim yapılır./On request special production is available.

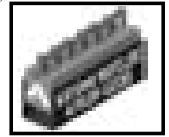

YAYLI ZİNCİR GERGİSİ/CHAIN TENSIONER

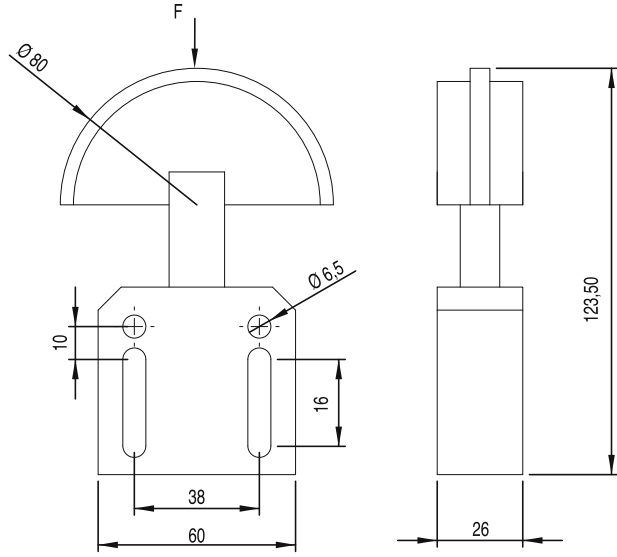
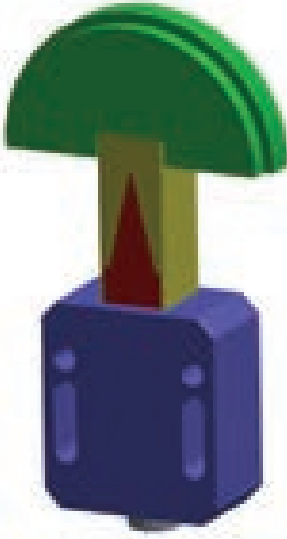

Doğru Montaj/Correct Assembly

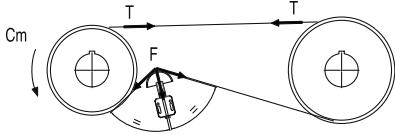



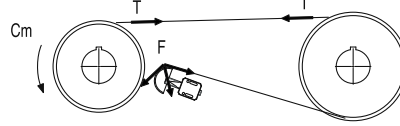



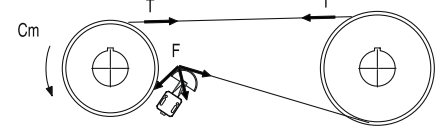





Yanlış Montaj/Wrong Assembly











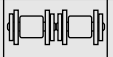

Yanlış Montaj/Wrong Assembly



		Sıra/Guide		Stok Kod Stock Code	F Baskı Kuvveti Tension Pressure (N)	
ALPOLEN® 1000 Kırmızı/Red		3/8"	1	12	207 GKR 138	36-79
ALPOLEN® 1000 Kırmızı/Red		1/2"	1	12	207 GKR 112	36-79
ALPOLEN® 1000 Kırmızı/Red		5/8"	1	12	207 GKR 158	36-79
ALPOLEN® 1000 Kırmızı/Red		3/4"	1	12	207 GKR 134	64-142
ALPOLEN® 1000 Kırmızı/Red		1"	1	12	207 GKR 101	64-142
ALPOLEN® 1000 Yeşil/Green		3/8"	1	12	207 GYR 138	36-79
ALPOLEN® 1000 Yeşil/Green		1/2"	1	12	207 GYR 112	36-79
ALPOLEN® 1000 Yeşil/Green		5/8"	1	12	207 GYR 158	36-79
ALPOLEN® 1000 Yeşil/Green		3/4"	1	12	207 GYR 134	64-142
ALPOLEN® 1000 Yeşil/Green		1"	1	12	207 GYR 101	64-142

*LÜTFEN ÖZEL ÖLÇÜLERİ TALEP EDİNİZ./TO MAKE AN ORDER INDICATE DIMENSIONS.

ZİNCİR GERGİSİ/CHAIN STRETCHER

		Sıra/Guide		Stok Kod Stock Code	F Baskı Kuvveti Tension Pressure (N)	
ALPOLEN® 1000 Kırmızı/Red		3/8"	2	12	207 GKR 208	64-142
ALPOLEN® 1000 Kırmızı/Red		1/2"	2	12	207 GKR 212	64-142
ALPOLEN® 1000 Kırmızı/Red		5/8"	2	12	207 GKR 258	64-142
ALPOLEN® 1000 Kırmızı/Red		3/4"	2	12	207 GKR 234	108-239
ALPOLEN® 1000 Yeşil/Green		3/8"	2	12	207 GYR 208	64-142
ALPOLEN® 1000 Yeşil/Green		1/2"	2	12	207 GYR 212	64-142
ALPOLEN® 1000 Yeşil/Green		5/8"	2	12	207 GYR 258	64-142
ALPOLEN® 1000 Yeşil/Green		3/4"	2	12	207 GYR 234	108-239

*LÜTFEN ÖZEL ÖLÇÜLERİ TALEP EDİNİZ./TO MAKE AN ORDER INDICATE DIMENSIONS.

*Özel üretim yapılır./On request special production is available.

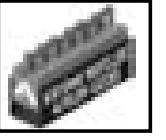

ALPOLEN® YARI MAMÜL PLAKALAR/ALPOLEN® SHEETS AND BARS

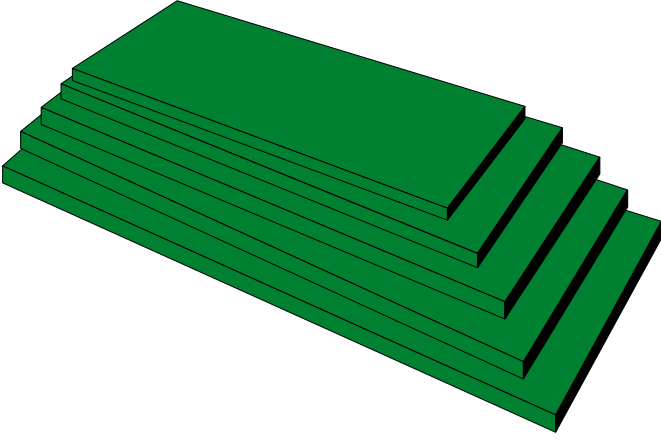

ÖLÇÜLER/DIMENSIONS: 2000 X 1000 mm
KALINLIK/THICKNESS: 2-150 mm
RENKLER/COLOURS:
YEŞİL-SİYAH-BEYAZ/GREEN-BLACK-WHITE

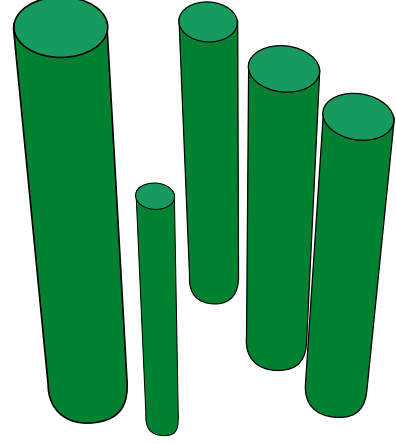

ÖLÇÜLER/DIMENSIONS: Ø20-Ø300 mm
UZUNLUK/LENGTH: 1000 mm
RENKLER/COLOURS:
YEŞİL-SİYAH-BEYAZ/GREEN-BLACK-WHITE

PVC KENAR DAYAMA PROFİLİ/PVC SIDE GUIDES

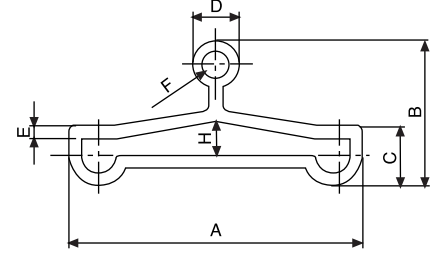
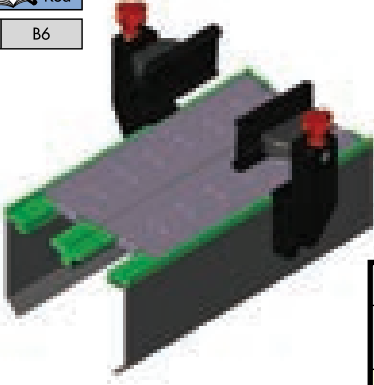
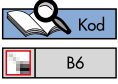

Profil Bölümü/Profiles:"YD4"

M	A	B	C	D	E	F	H	L	Stok Kod Stock Code
PVC Siyah / Black	60	29	12	9	2,5	5,5	6,5	3	207 YD4 060
PVC Siyah / Black	60	29	12	9	2,5	5,5	6,5	6	207 YD4 066

L:Standart Uzunluk(metre)/Standart Length(meter)

DOĞRUSAL YATAKLAR (863 SERİSİ)/STRAIGHT TRACK (FOR 863 SERIES)

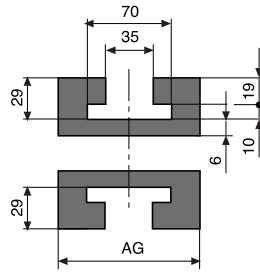
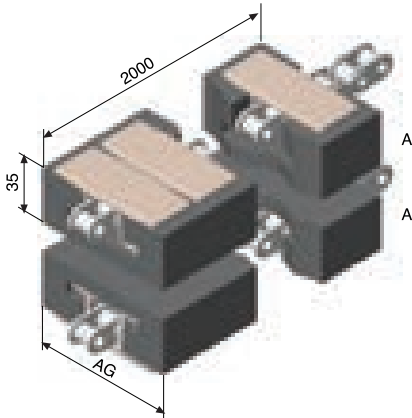
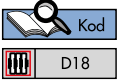



1 SET = GİDİŞ + DÖNÜŞ
1 SET = CARRY + RETURN
1 SET = 4 m

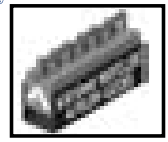
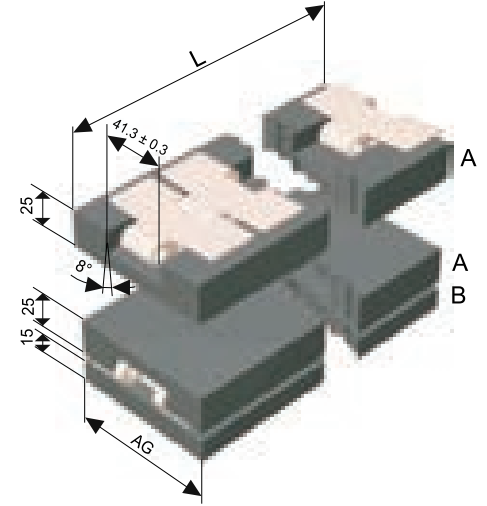

M	Bant Geniliği Chain Width	AG	Stok Kod Stock Code
Alpolen® 1000 Siyah / Black	82,6	100	202 863 082
Alpolen® 1000 Siyah / Black	114,3	130	202 863 114
Alpolen® 1000 Siyah / Black	190,5	200	202 863 190
Alpolen® 1000 Siyah / Black	254,0	270	202 863 254
Alpolen® 1000 Siyah / Black	304,8	320	202863 304

*Özel üretim yapılır./On request special production is available.

ALPOLEN® 1000 DOĞRUSAL YATAKLARI 880-881 BANTLAR İÇİN/ STRAIGHT TRACK (For 880-881 Chains)

Profil/Profiles: C

	Bant Genişlik Chain Width	Kg/m	Stok Kod Stock Code	L (m)
ALPOLEN® 1000 Siyah ALPOLEN® 1000 Black	82,6	5,00	202 880 082	2
	114,3	6,90	202 880 114	2
	190,5	11,35	202 880 190	2

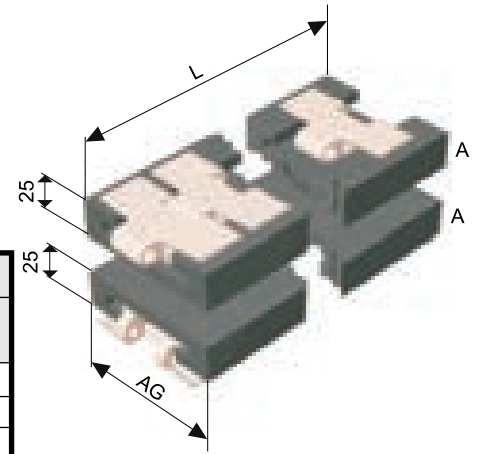
1 Set = Gidiş ve Dönüş (A+A+B)/1 Set = Carry and Return (A+A+B)

ALPOLEN® 1000 DOĞRUSAL YATAKLARI 880TAB-881TAB BANTLAR İÇİN/ STRAIGHT TRACK (For 880-881 TAB Chains)

Profil/Profiles: C

	Bant Genişlik Chain Width	Kg/m	Stok Kod Stock Code	L (m)
ALPOLEN® 1000 Siyah ALPOLEN® 1000 Black	82,6	2,95	202 88T 082	2
	114,3	4,80	202 88T 114	2
	190,5	7,80	202 88T 190	2

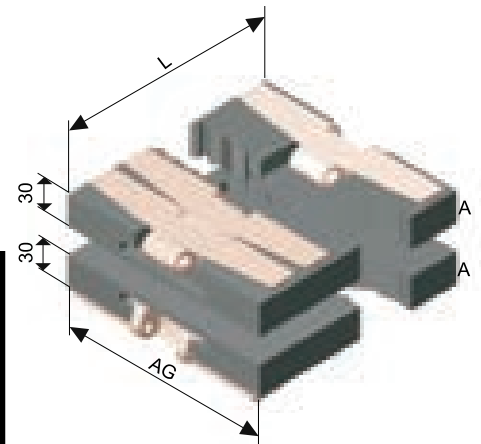
1 Set = Gidiş ve Dönüş (A+A)/1 Set = Carry and Return (A+A)

ALPOLEN® 1000 DOĞRUSAL YATAKLARI AĞIR TİP 882 BANTLAR İÇİN/ STRAIGHT TRACK (For 882 Chains)

Profil/Profiles: C

	Bant Genişlik Chain Width	Kg/m	Stok Kod Stock Code	L (m)
ALPOLEN® 1000 Siyah ALPOLEN® 1000 Black	190,5	8,65	202 882 190	2
	254,3	12,70	202 882 254	2
	304,8	15,65	202 882 304	2

1 Set = Gidiş ve Dönüş (A+A)/1 Set = Carry and Return (A+A)

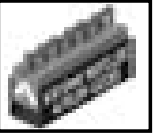
*Özel üretim yapılır./On request special production is available.



ALPOLEN® 1000 90 DERECE (880 TAB-881 TAB DÖNÜŞLÜ BANTLAR İÇİN) DÖNÜŞ YATAKLARI/CURVE TRACKS FOR 880 TAB-881 TAB CHAINS

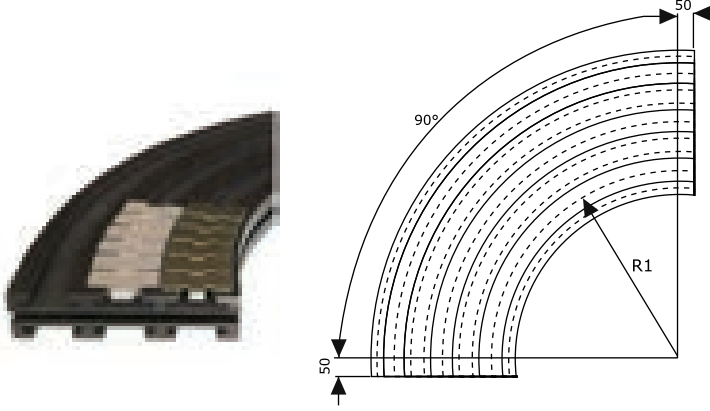

1 SET = GİDİŞ + DÖNÜŞ
1 SET = CARRY + RETURN

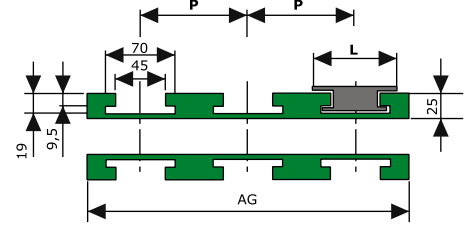

L = 82,6 P = 84mm				
M	R1	Sıra Track	AG	Stok Kod Stock Code
Alpolen® 1000 Siyah / Black	500	1	100	215 500 182
	500	2	184	215 500 282
	500	3	268	215 500 382
	500	4	352	215 500 482
	500	5	436	215 500 582
	500	6	520	215 500 682
	610	1	100	215 610 182
	610	2	184	215 610 282
	610	3	268	215 610 382
	610	4	352	215 610 482
	610	5	436	215 610 582
	610	6	520	215 610 682
	800	1	100	215 800 182
	800	2	184	215 800 282
	800	3	268	215 800 382
	800	4	352	215 800 482
	800	5	436	215 800 582
	800	6	520	215 800 682
	1000	1	100	215 100 182
	1000	2	184	215 100 282
	1000	3	268	215 100 382
	1000	4	352	215 100 482
	1000	5	436	215 100 582
	1000	6	520	215 100 682

L = 82,6 P = 85mm				
M	R1	Sıra Track	AG	Stok Kod Stock Code
Alpolen® 1000 Siyah / Black	500	1	114	215 501 182
	500	2	185	215 501 282
	500	3	270	215 501 382
	500	4	355	215 501 482
	500	5	440	215 501 582
	500	6	525	215 501 682
	610	-	-	215 611 182
	610	2	185	215 611 282
	610	3	270	215 611 382
	610	4	355	215 611 482
	610	5	440	215 611 582
	610	6	525	215 611 682
	800	-	-	215 801 182
	800	2	185	215 801 282
	800	3	270	215 801 382
	800	4	355	215 801 482
	800	5	440	215 801 582
	800	6	525	215 801 682
	1000	-	-	215 101 182
	1000	2	185	215 101 282
	1000	3	270	215 101 382
	1000	4	355	215 101 482
	1000	5	440	215 101 582
	1000	6	525	215 101 682

L = 82,6 P = 88mm				
M	R1	Sıra Track	AG	Stok Kod Stock Code
Alpolen® 1000 Siyah / Black	500	1	-	215 502 182
	500	2	188	215 502 282
	500	3	276	215 502 382
	500	4	364	215 502 482
	500	5	452	215 502 582
	500	6	540	215 502 682
	610	-	-	215 612 182
	610	2	188	215 612 282
	610	3	276	215 612 382
	610	4	364	215 612 482
	610	5	452	215 612 582
	610	6	540	215 612 682
	800	-	-	215 802 182
	800	2	188	215 802 282
	800	3	276	215 802 382
	800	4	364	215 802 482
	800	5	452	215 802 582
	800	6	540	215 802 682
	1000	-	-	215 101 182
	1000	2	188	215 102 282
	1000	3	276	215 102 382
	1000	4	364	215 102 482
	1000	5	452	215 102 582
	1000	6	540	215 102 682

L = 114,3 P = 120mm				
M	R1	Sıra Track	AG	Stok Kod Stock Code
Alpolen® 1000 Siyah / Black	500	1	130	215 500 114
	500	2	250	215 500 214
	610	1	130	215 610 114
	610	2	250	215 610 214
	800	1	130	215 800 114
	800	2	250	215 800 214
	1000	1	130	215 100 114
	1000	2	250	215 100 214

L = 190,5 P = 196mm				
M	R1	Sıra Track	AG	Stok Kod Stock Code
Alpolen® 1000 Siyah / Black	500	1	200	215 500 119
	500	2	396	215 500 219
	610	1	200	215 610 119
	610	2	396	215 610 219
	800	1	200	215 800 119
	800	2	396	215 800 219
	1000	1	200	215 100 119
	1000	2	396	215 100 219

*Özel üretim yapılır./On request special production is available.

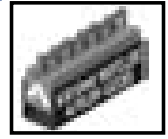

ALPOLEN® 1000 90 DERECE (880 AÇILI KULAKLI BANTLAR İÇİN) DÖNÜŞ YATAKLARI/CURVE TRACKS (FOR 880 CHAINS)

L = 82.6				
P = 90mm				
M	R1	Sıra Track	AG	Stok Kod Stock Code
Alpolen® 1000 Siyah / Black	500	1	100	205 500 182
	500	2	190	205 500 282
	500	3	280	205 500 382
	500	4	370	205 500 482
	610	1	100	205 610 082
	650	1	100	205 650 182
	650	2	190	205 650 282
	650	3	280	205 650 382
	650	4	370	205 650 482
	860	1	100	205 860 281
	860	2	190	205 860 282
	860	3	280	205 860 283
860	4	370	205 860 284	



1 SET = GİDİŞ + DÖNÜŞ
1 SET = CARRY + RETURN



L = 114.3				
P = 125mm				
M	R1	Sıra Track	AG	Stok Kod Stock Code
Alpolen® 1000 Siyah / Black	550	1	130	205 550 114
	550	2	255	205 550 214
	550	3	380	205 550 314
	550	4	505	205 550 414
	610	1	130	205 610 114
	650	1	130	205 650 114
	650	2	255	205 650 214
	650	3	380	205 650 314
	650	4	505	205 650 414

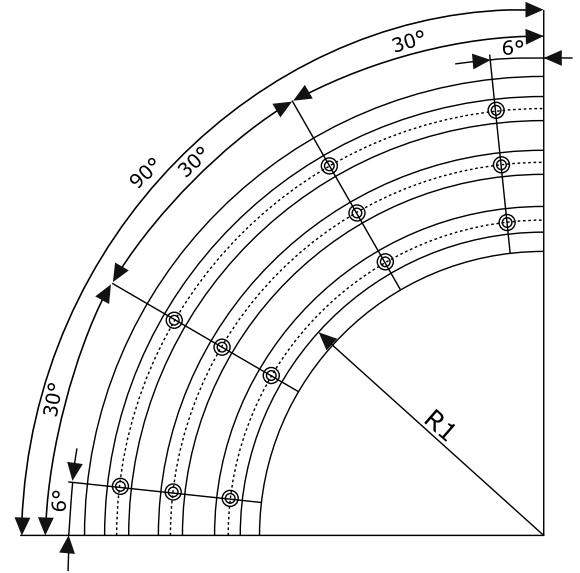

L = 190.5				
P = 125mm				
M	R1	Sıra Track	AG	Stok Kod Stock Code
Alpolen® 1000 Siyah / Black	610	1	200	205 610 119
	650	1	200	205 650 119

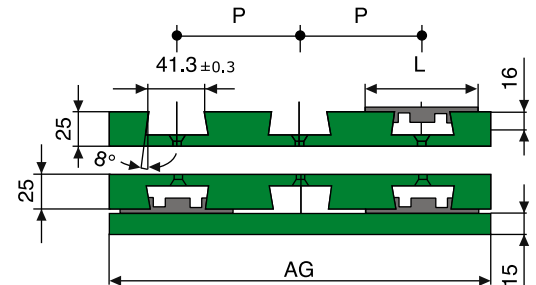

*Özel üretim yapılır./On request special production is available.

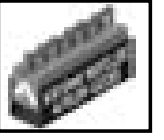

ALPOLEN® 1000 90 DERECE DÖNÜŞ YATAKLARI (882 TAB DÖNÜŞLÜ AĞIR TİP BANTLAR İÇİN) / CURVE TRACKS (FOR 882 TAB CHAINS / HEAVY DUTY)

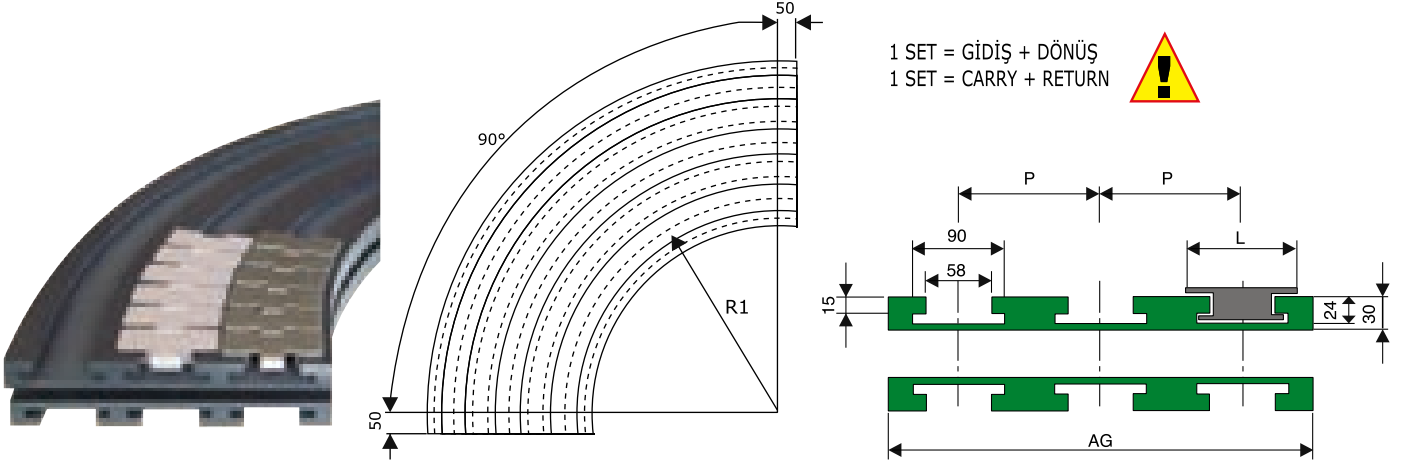

L = 114.3				
P = 120mm				
M	R1	Sıra Track	AG	Stok Kod Stock Code
Alpolen® 1000 Siyah / Black	610	1	130	215 610 114
	610	2	250	215 610 214
	800	1	130	215 800 114
	800	2	250	215 800 214
	1000	1	130	215 100 114
	1000	2	250	215 100 214
	1200	1	130	215 120 114
	1200	2	250	215 120 214

L = 190.5				
P = 196mm				
M	R1	Sıra Track	AG	Stok Kod Stock Code
Alpolen® 1000 Siyah / Black	610	1	200	220 610 119
	610	2	396	220 610 219
	800	1	200	220 800 119
	800	2	396	220 800 219
	1000	1	200	220 100 119
	1000	2	396	220 100 219
	1200	1	200	220 120 119
	1200	2	396	220 120 219

L = 254				
P = 260mm				
M	R1	Sıra Track	AG	Stok Kod Stock Code
Alpolen® 1000 Siyah / Black	610	1	270	220 610 125
	610	2	530	220 610 225
	800	1	270	220 800 125
	800	2	530	220 800 225
	1000	1	270	220 100 125
	1000	2	530	220 100 225
	1200	1	270	220 120 125
	1200	2	530	220 120 225

L = 304.8				
P = 310mm				
M	R1	Sıra Track	AG	Stok Kod Stock Code
Alpolen® 1000 Siyah / Black	610	1	320	220 610 130
	610	2	630	220 610 230
	800	1	320	220 800 130
	800	2	630	220 800 230
	810	1	340	220 810 130
	1000	1	320	220 100 130
	1000	2	630	220 100 230
	1000	2	630	220 100 230
	1160	1	340	220 116 130
	1200	1	320	220 100 130
	1200	1	320	220 100 130
	1200	2	630	220 100 230

*Özel üretim yapılır./On request special production is available.

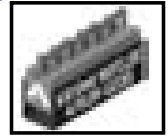

OMURGALI (KARDENİK) BANT DÖNÜŞ TAKIMI/CURVE TRACKS FOR CARDANIC CHAINS

Kod	860 - 865 867 - 870 875
Say.	D22 - D23

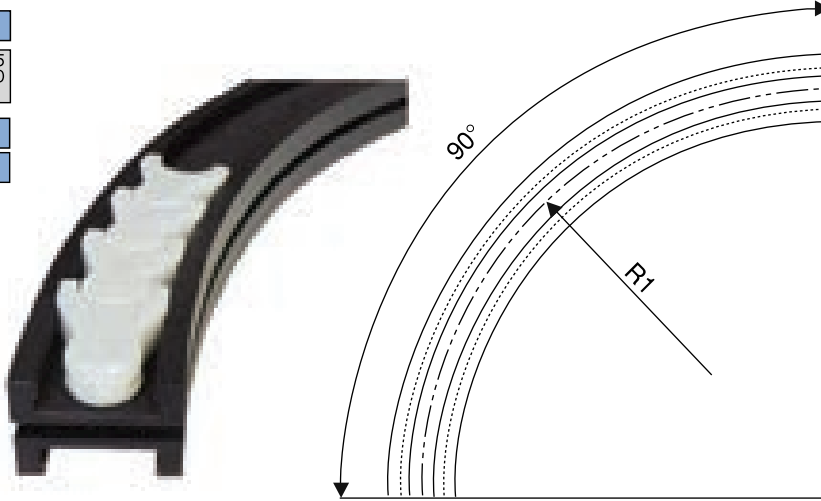

1 SET = GİDİŞ + DÖNÜŞ
1 SET = CARRY + RETURN

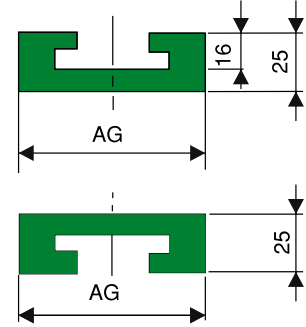

M		R1	R2	R3	AG	Stok Kod Stock Code
Alpolen® 1000 Siyah / Black	865	150	-	-	80	225 150 082
	865	150	215	-	145	225 150 182
	865	150	215	280	210	225 150 282
	865	250	-	-	80	225 250 082
	865	500	-	-	80	225 500 082
	865	630	-	-	80	225 630 082

M		R1	R2	R3	AG	Stok Kod Stock Code
Alpolen® 1000 Siyah / Black	860	150	-	-	80	226 150 082
	860	500	-	-	80	226 500 182

KASA TAŞIMA BANT KIZAKLARI/GUIDES FOR CRATE CHAINS

Kod	855 - 856 857 - 858
Say.	D22 - D23

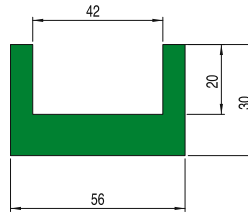

220 KSK 857

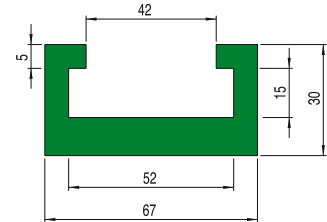

220 KSK 858

M	Kullanılan Bantlar For chains	Kg/m	Stok Kod Stock Code
Alpolen® 1000 Siyah / Black	857	0,98	220 KSK 857
	858	1,17	220 KSK 858

*Özel üretim yapılır./On request special production is available.

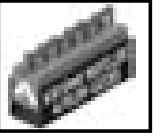

YARASA BANT DÖNÜŞ ÜNİTESİ/CURVE TRACKS FOR BAT CHAINS

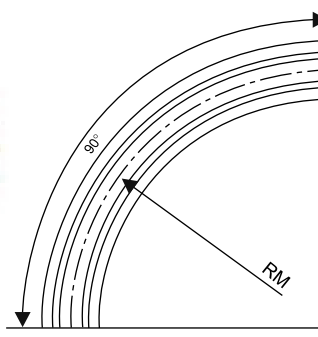

1 SET = GİDİŞ + DÖNÜŞ
1 SET = CARRY + RETURN

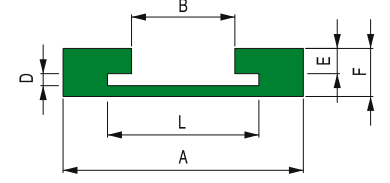

M	A	B	L	D	E	F	RM	Kg/m	Stok Kod Stock Code
Alpolen® 1000 Siyah / Black	100	43	63	5	10,5	20	250	0,160	204 112 610

YARASA BANT DÖNÜŞ ÜNİTESİ (SİLİNDİRİK KULAKLILAR İÇİN)/CURVE TRACKS FOR BAT CHAINS

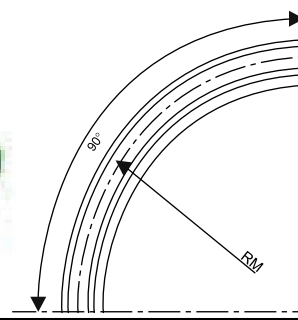

1 SET = GİDİŞ + DÖNÜŞ
1 SET = CARRY + RETURN

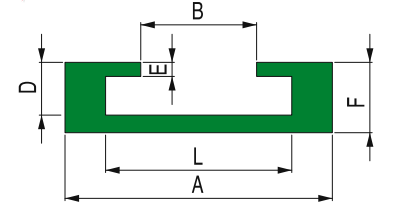

M	A	B	L	D	E	F	RM	Kg/m	Stok Kod Stock Code
Alpolen® 1000 Siyah / Black	114	49,4	79,4	16,5	6	30	500	1,60	204 114 610
	85	35,5	58	12	10	30	370	1,30	204 085 610

ALPOLEN® 1000 90 DERECE DÖNÜŞ YATAKLARI (1873 SERİ BANTLAR İÇİN)/CURVE TRACKS (FOR 1873 SERIES)

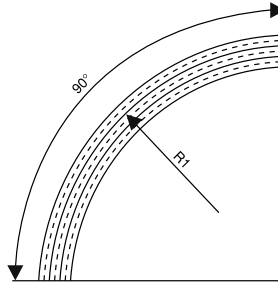
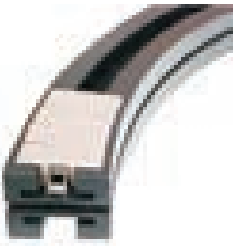

1 SET = GİDİŞ + DÖNÜŞ
1 SET = CARRY + RETURN

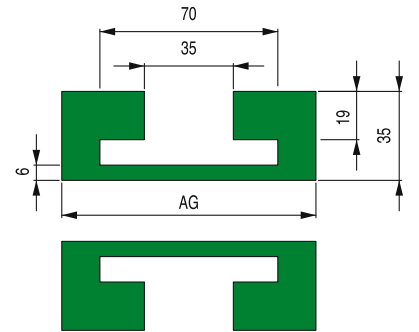

M	R1	Sıra Track	AG	Stok Kod Stock Code
Alpolen® 1000 Siyah Alpolen® 1000 Black	610	82,5	1	100 221 611 873
	800	82,5	1	100 221 801 873
	610	114,3	1	130 222 611 873
	800	114,3	1	130 222 801 873
	610	190,5	1	200 223 611 873
	800	190,5	1	200 223 801 873
	610	254,0	1	270 224 611 873
	800	254,0	1	270 224 801 873
	610	304,8	1	320 220 611 873
	800	304,8	1	320 220 801 873

*Özel üretim yapılır./On request special production is available.

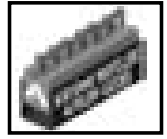

UYGULAMALAR/APPLICATIONS

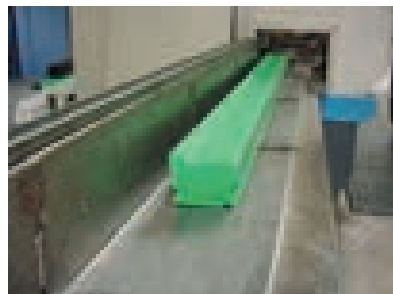
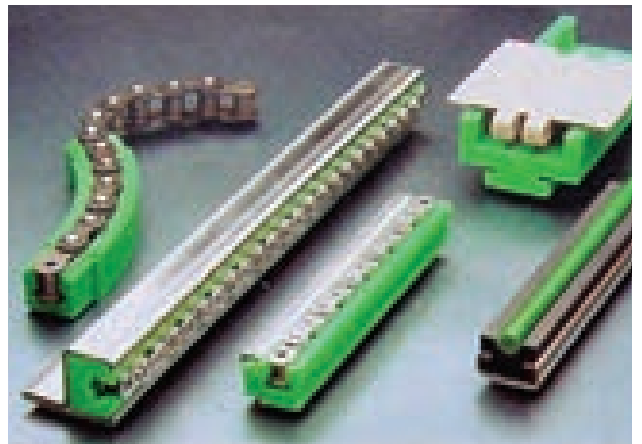
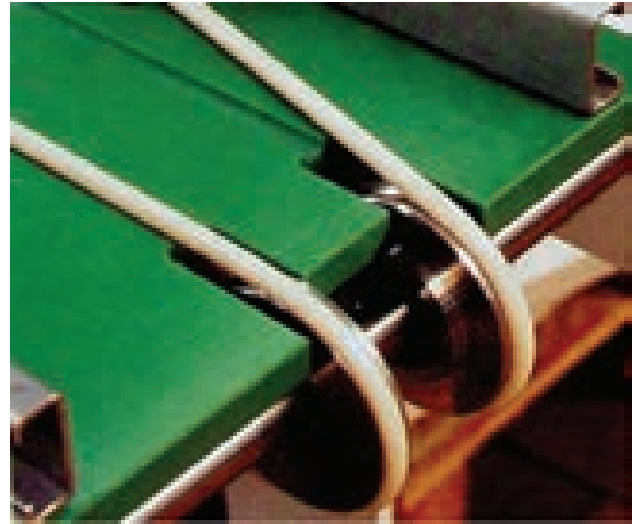
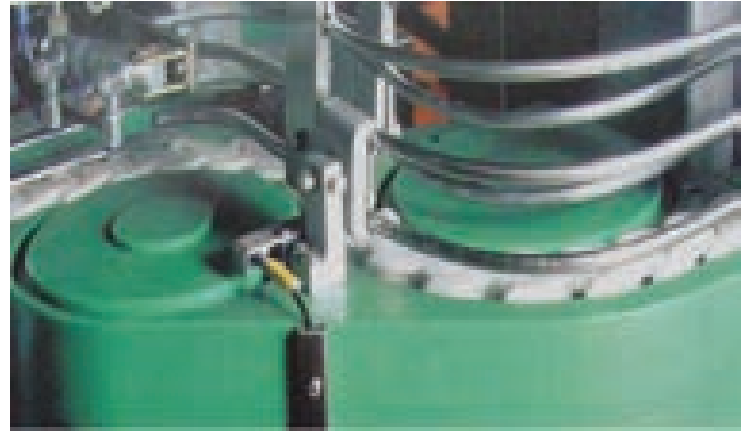
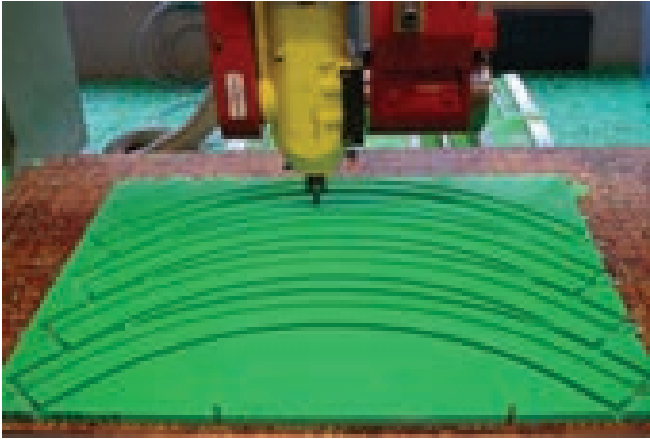
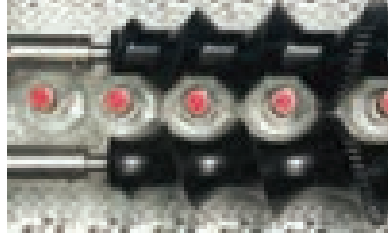
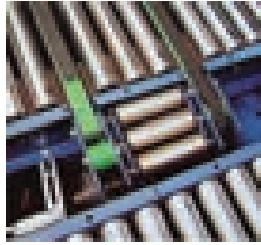
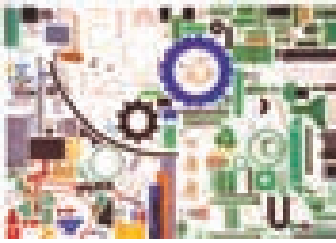

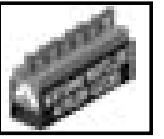

UYGULAMALAR/APPLICATIONS

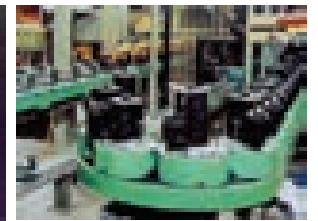
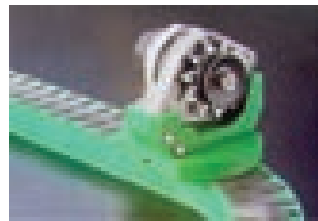
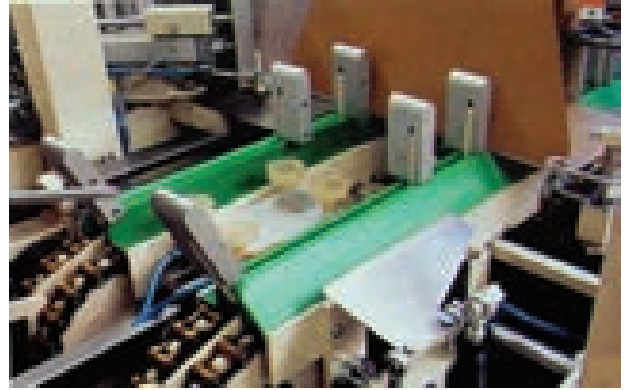
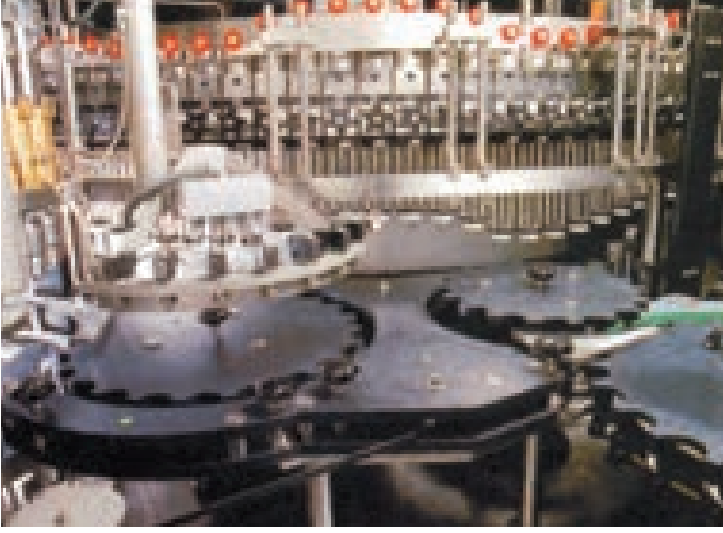

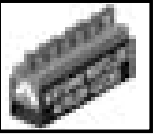

UYGULAMALAR/APPLICATIONS

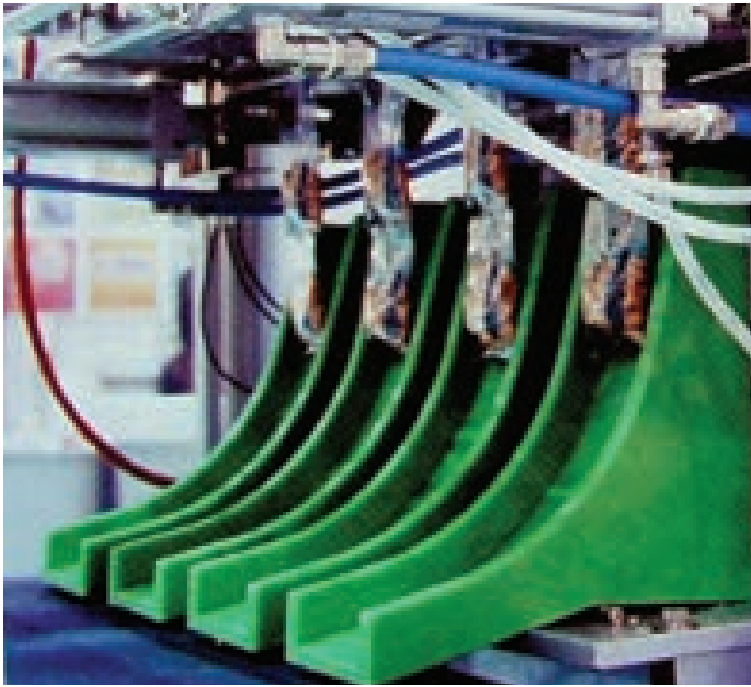

Kımyasal Dirençler Chemical Resistance Temperatures up to 65°C 65°C'ye Kadar	Polyamid Polyamide	Çelik Steel	Paslanmaz Çelik Stainless Steel AISI 304	Paslanmaz Çelik Stainless Steel AISI 430	Düşük Sürtümlü Asetal LF Acetal (POM)	ALPOLEN® 1000 UHMW	Polipropilen Polypropylene (PP)
Aseton Acetone	+	-	+	+	+	+	+
Asedik Asit Acetic Acid (max.5%)	-	-	+	-	-	+	+
Sitrik Asit Citric Acid	0	-	+	0	0	+	0
Formik Asit Formic Acid	-	+	+	+	-	+	+
Fosforik Asit Phosphoric Acid (max.10%)	-	-	+	-	-	+	+
Hidroklorik Asit Hydrochloric Acid (max.2%)	-	-	-	-	-	+	+
Laktik Asit Lactic Acid	+	-	+	-	+	+	+
Nitrik Asit Nitric Acid	-	-	+	0	-	0	+
Sülfit Asit Sulphide Acid	-	-	-	-	-	-	+
Yağ Oil (vegetable or mineral)	+	+	0	+	+	+	+
Sabun Soap and water	+	0	+	+	+	+	+
Tatlı Su Water	+	-	+	+	+	+	+
Deniz Suyu Sea water	-	0	+	0	+	+	+
Alkol Alcohol	+	+	+	+	+	+	+
Amonyak Ammonia	+	0	+	+	-	+	+
Alkolsüz İçki Soft drinks	+	+	+	+	+	+	+
İspirto Spirits	+	+	+	+	+	+	+
Benzen Benzene	+	+	+	+	+	0	-
Benzol Benzol	+	+	+	+	+	+	0
Bira Beer	+	+	+	+	+	+	+
Çikolata Chocolate	0	+	+	+	0	0	+
Sodyum Hidroklorid Sodium Hydrochloride	+	-	0	-	+	+	+
Petrol Petrol	+	+	+	+	+	0	+

Kimyasal Dirençler Chemical Resistance Temperatures up to 65°C 65°C'ye Kadar	Polyamid Polyamide	Çelik Steel	Paslanmaz Çelik Stainless Steel AISI 304	Paslanmaz Çelik Stainless Steel AISI 430	Düşük Sürtünmeli Asetal LF Acetal (POM)	ALPOLEN® 1000 UHMW	Polipropilen Polypropylene (PP)
Sodyum Hidroksid Sodium hydroxide (max.25%)	+	-	+	+	-	+	+
Sodyum Hipoklorid Sodium hypochlorite	+	-	-	-	-	+	+
Meyve Suyu Fruit Juices	+	-	+	0	+	+	+
Sebze Suyu Juices vegetable	+	0	+	+	+	+	+
Süt Milk	+	+	+	+	+	+	+
Hardal Mustard	0	+	+	+	+	0	+
Parafin Paraffin	+	+	+	+	+	+	0
Hidrojen Peroksit Hydrogen peroxide	-	-	+	0	-	0	+
Karbon Tetraklorid Carbon tetrachloride	+	0	0	0	+	0	-
Toluene	-	-	-	-	+	0	+
Turpentin Turpentine	-	+	+	+	-	0	+
Sirke Vinegar	+	-	0	-	+	+	+
Şarap Wine	+	+	+	+	+	+	+
Viski Whisky	+	+	+	+	+	+	+
Lodine	-	0	0	0	0	0	0
Xilol	-	-	-	-	-	-	-

+ = İyi / Good

0 = Orta / Average

- = Yetersiz / Unsatisfactory

Yukarıda belirtilen değerler firma tecrübesine dayalı olup garanti niteliği taşımamaktadır.

Malzemeler ve ürünler çalışma şartları doğrultusunda test edilerek uygun koşullar saptanmalıdır.

Ürünlerimizin Mekanik Analizleri Pro-Engineer Wildfire Programında yapılmaktadır.

This information may be considered as a basis for recommendation, but not as a guarantee.

Materials and products should be tested under exact intended service conditions to determine their suitability for a particular purpose.

Mechanical Analysis of products on  Pro-Engineer Wildfire Software.

**MALZEME UYGUNLUK KODU
MATERIAL SUITABILITY CODE**

- R = Tavsiye edilir/Recommended**
NR = Tasviye Edilmez/Not Recommended
Q = Kuşkuolu/Questionable
— = Bilgi Mevcut değil/No Available Information

KİMYASALIN ADI CHEMICAL NAME	STANDART MALZEMELER/STANDARD MATERIALS							
	PP		PE		POM		PP Isıya Dayanıklı Heat Resistant	
	(21 °C)	(60 °C)	(21 °C)	(60 °C)	(21 °C)	(60 °C)	(21 °C)	(60 °C)
Asetik Asit / Acetic Acid	R	R	R	Q	—	—	NR	NR
Acetic Acid - %5 /Asetik Asit - % 5	R	R	R	R	R	—	NR	NR
Aseton / Acetone	R	R	R	R	Q	Q	R	R
Alcehol - Tüm Türleri / Alcehol - All Types	R	R	R	R	—	—	R	R
Şap - Tüm Türleri / Alum - All Types	R	R	R	R	—	—	—	Q
Alüminyum Bileşikler / Aluminum Compounds	R	R	R	R	—	—	R	R
Amonyak / Ammonia	R	R	R	R	—	—	R	R
Amonyum Bileşikleri / Ammonium Compounds	R	R	R	R	—	—	R	Q
Amonyum Bileşikleri / Ammyl Acetate	Q	NR	Q	NR	—	—	N	R
Ammyl Klorür / Ammyl Chloride	NR	NR	Q	NR	—	—	—	—
Anilin / Aniline	R	R	R	NR	—	Q	—	Q
Aqua Regia / Aqua Regia	NR	NR	Q	NR	—	—	NR	—
Arsenik Asit / Arsenic Acid	R	R	R	R	—	—	—	—
Baryum Bileşikleri / Barium Compounds	R	R	R	R	—	—	R	R
Baryum Sabun Gres / Barium Soap Grease	R	Q	—	—	—	—	—	—
Bira / Beer	R	R	R	R	—	—	—	R
Benzen / Benzene	Q	NR	Q	NR	R	Q	R	R
Benzenesulfonic Asit -%10 / Benzenesulfonic Acid - %10	R	R	R	R	—	—	—	R
Benzoik Asit / Benzoic Acid	R	R	R	R	—	—	Q	R
Boraks / Borax	R	R	R	R	—	—	—	—
Borik Asit / Boric Acid	R	R	R	R	—	—	R	Q
Fren Sıvısı / Brake Fluid	R	R	—	—	R	R	R	R
Salamura -% 10 / Brine - %10	R	R	R	R	R	R	—	—
Bromik Asit / Bromic Acid	NR	NR	NR	NR	—	—	NR	—
Brom - Duman Sıvı / Bromine - Liquid of Fumes	NR	NR	NR	NR	—	—	NR	—
Brom Su / Bromine Water	NR	NR	Q	NR	—	—	R	R
Bütil Asetat / Butyl Acetate	NR	NR	R	Q	—	—	—	—
Bütil Akrilat / Butyl Acrylate	R	—	R	Q	—	—	Q	R
Butirik Asit / Butyric Acid	R	R	R	R	—	—	Q	—
Kalsiyum Bileşikleri / Calcium Compounds	R	Q	—	—	—	—	—	—
Kalsiyum Sabun Gres / Calcium Soap Grease	R	R	—	—	R	R	—	—
Calgonite -% 0.3 / Calgonite - 0.3%	R	R	R	R	—	—	R	R
Karbondoksit / Carbon Dioxide	Q	NR	Q	NR	—	—	R	R
Karbon Disülfid / Carbon Disulfide	NR	NR	NR	NR	R	Q	R	R
Karbon Tetraklorür / Carbon Tetrachloride	R	R	—	—	—	—	—	—
Cellosolve - TM / Cellosolve - TM	R	R	—	—	—	—	—	NR
Chloracetic Asit / Chloracetic Acid	NR	NR	Q	NR	NR	NR	—	NR
Klor Gaz / Chlorine - Gas	NR	NR	NR	NR	NR	NR	NR	NR
Klor Sıvı / Chlorine - Liquid	R	Q	R	Q	NR	NR	—	NR
Klor Su (% 0,4 Cl) / Chlorine Water (0.4% Cl)	NR	NR	Q	NR	—	—	R	R
Klorobenzen / Chlorobenzene	NR	NR	NR	NR	—	—	Q	—
Kloroform / Chloroform	NR	NR	NR	NR	—	—	NR	NR
Chlorosufonic Asit / Chlorosufonic Acid	R	R	R	Q	—	—	NR	—
Kromik Asit - 50% / Chromic Acid - 50%	R	R	R	R	—	—	—	R
Sitrik Asit / Citric Acid	R	R	R	R	R	—	R	R
Sitrik Asit% 10 / Citric Acid 10%	R	R	R	R	—	—	R	R
Narenciye Suları / Citrus Juices	R	Q	—	—	NR	NR	—	NR
Clorox - TM / Clorox - TM	R	R	R	R	—	—	—	—
Hindistan Cevizi Yağı / Coconut Oil	R	R	R	R	—	—	Q	—
Bakır Bileşikler / Copper Compounds	R	R	R	R	—	—	—	—
Mısır Yağı / Corn Oil	R	R	R	R	—	—	—	—
Pamuk Yağı / Cottonseed Oil	R	R	R	Q	—	—	NR	NR
Kresol / Cresol	R	Q	NR	NR	—	—	—	—
Sikloheksan / Cyclohexane	R	Q	Q	NR	—	—	R	—
Sikloheksanole / Cyclohexanol	R	Q	NR	NR	—	—	R	—
Sikloheksanon / Cyclohexanone	R	R	R	R	R	R	R	—
Deterjanlar / Detergents	R	R	R	R	—	—	—	—
Dekstrin / Dextrin	R	Q	—	—	—	—	R	R
Ftalat Dibütil / Dibutyl Phthalate	NR	NR	NR	NR	Q	Q	R	R
Dietil Eter / Diethyl Ether	R	R	—	NR	—	—	R	—
Dietilamin / Diethylamine	R	R	R	R	—	—	—	—
Diglycolic Asit -% 30 / Diglycolic Acid - %30	R	R	—	—	—	—	—	—
Diisooctyl Ftalat / Diisooctyl Phthalate	R	R	—	—	—	—	—	—
Ftalat dimetil / Dimethyl Phthalate	R	—	—	—	—	—	R	R
Dimethylamine / Dimethylamine	R	Q	—	—	—	—	R	R



**MALZEME UYGUNLUK KODU
MATERIAL SUITABILITY CODE**

R = Tavsiye edilir/Recommended
NR = Tasviye Edilmez/Not Recommended
Q = Kuşkulu/Questionable
- = Bilgi Mevcut değil/No Available Information

KİMYASALIN ADI CHEMICAL NAME	STANDART MALZEMELER/STANDARD MATERIALS							
	PP		PE		POM		PP Isıya Dayanıklı Heat Resistant	
	(21 °C)	(60 °C)	(21 °C)	(60 °C)	(21 °C)	(60 °C)	(21 °C)	(60 °C)
Diglycolic Asit -% 30 / Diglycolic Acid - %30	R	R	Q	Q	Q	NR	R	R
Diisooctyl Ftalat / Diisooctyl Phthalate	Q	Q	—	—	—	—	—	—
Ftalat dimetil / Dimethyl Phthalate	R	R	—	—	—	—	—	—
Dimethylamine / Dimethylamine	NR	NR	—	—	—	—	—	—
Dioktil Ftalat / Dioctyl Phthalate	R	R	R	R	R	Q	R	Q
Etil Asetat / Ethyl Acetate	R	R	R	R	—	—	Q	—
Etil Eter / Ethyl Ether	R	R	R	Q	—	—	—	—
Ethylamine / Ethylamine	R	Q	R	Q	—	—	NR	NR
Etilen Klorür / Ethylene Chloride	—	—	R	R	Q	Q	—	—
Etilen glikol -% 50 / Ethylene Glycol - %50	R	Q	R	NR	Q	Q	R	R
Ferrik - Demirli Bileşikler / Ferric - Ferrous Compounds	NR	NR	Q	NR	—	—	R	—
Formaldehit -% 37 / Formaldehyde - 37%	Q	NR	R	NR	R	R	R	R
Formik Asit - 85% / Formic Acid - 85%	R	R	R	R	—	—	—	—
Freon / Freon	R	R	—	—	—	—	R	R
Fuel Oil # 2 / Fuel Oil #2	NR	NR	Q	NR	R	R	R	R
Furfural / Furfural	R	Q	NR	NR	—	—	R	R
Benzin / Gasoline	R	R	R	R	—	—	NR	NR
Glikoz / Glucose	R	R	R	R	NR	NR	NR	NR
Gliserin / Glycerol	R	R	R	R	NR	NR	NR	NR
Heptan / Heptane	R	R	R	R	NR	NR	NR	NR
Hekzan / Hexane	R	R	R	R	R	R	Q	Q
Hidrobromik Asit -% 50 / Hydrobromic Acid - 50%	Q	Q	R	Q	—	—	NR	NR
Hidrobromik Asit / Hydrobromic Acid	R	R	R	R	—	—	R	R
Hidroklorik Asit -% 10 / Hydrochloric Acid - 10%	NR	NR	—	—	—	—	—	—
Hidroflorik Asit -% 35 / Hydrofluoric Acid - 35%	R	R	—	—	R	R	—	—
Hidrojen Peroksit -% 3 / Hydrogen Peroxide - 3%	R	R	Q	Q	—	—	—	NR
Hidrojen Peroksit - 90% / Hydrogen Peroxide - 90%	NR	NR	R	—	—	—	R	R
Hidrojen Sülfür / Hydrogen Sulfide	Q	NR	Q	Q	R	R	R	R
Hidroiyodik Asit / Hydroiodic Acid	Q	NR	Q	Q	R	R	R	—
Igepal -% 50 / Igepal - 50%	R	R	R	R	—	—	NR	NR
İyot - Kristaller / Iodine - Crystals	R	Q	R	R	—	—	—	—
İzooktan / Isooctane	—	—	R	R	—	—	—	R
Jet Yakıtı / Jet Fuel	R	R	R	R	—	—	—	—
Gazyağı / Kerosene	R	R	R	R	—	—	R	R
Laktik Asit / Lactic Acid	Q	NR	Q	NR	—	—	—	—
Lanolin / Lanolin	Q	NR	—	—	—	—	—	—
Domuz Yağı / Lard	R	—	—	—	—	—	—	—
Laurik Asit / Lauric Acid	R	R	R	R	R	R	R	R
Kurşun Asetat / Lead Acetate	R	Q	—	—	R	R	R	Q
Limon Yağı / Lemon Oil	R	R	R	R	—	—	Q	—
Ligroin / Ligroin	R	R	R	R	—	—	R	R
Kireç Sülfür / Lime Sulfur	R	—	R	R	—	—	Q	Q
Keten Yağı / Linseed Oil	R	R	R	R	—	—	—	—
Makine Yağı / Lubricating Oil	R	R	R	R	—	—	—	—
Magnezyum Bileşikleri / Magnesium Compounds	R	R	R	R	—	—	R	—
Malik Asit -50% / Malic Acid -50%	R	—	—	—	—	—	—	—
Manganez Sülfat / Manganese Sulfate	NR	NR	—	—	—	—	—	N
Margarin / Margarine	R	Q	NR	NR	—	—	R	—
Civa Bileşikleri / Mercuric Compounds	R	Q	—	—	—	—	—	—
Merkür / Mercury	Q	NR	NR	NR	—	—	Q	Q
Metil Cellosolve / Methyl Cellosolve	R	R	R	R	—	—	—	—
Metil Klorür / Methyl Chloride	Q	NR	R	NR	R	R	—	—
Metil Etil Keton / Methyl Ethyl Ketone	Q	NR	—	—	—	—	R	—
Metil ISOBUTYL Keton / Methyl Isobutyl Ketone	R	R	R	R	—	—	R	R
Metilen Klorür / Methylene Chloride	R	Q	—	—	R	R	R	R
Methylsulfuric Asit / Methylsulfuric Acid	R	Q	Q	NR	—	—	R	R
Madeni Yağ / Mineral Oil	R	R	R	R	—	—	Q	—
Mineral Spirits / Mineral Spirits	R	Q	R	R	NR	NR	NR	NR
Melas / Molasses	Q	NR	R	Q	NR	NR	NR	NR
Motor Yağı / Motor Oil	NR	NR	NR	NR	NR	NR	NR	NR
Naphta / Naphta	R	Q	NR	NR	—	—	Q	—
Nikel Bileşikler / Nickel Compounds	Q	NR	—	—	—	—	—	—
Nitrik Asit% 30 / Nitric Acid - 30%	R	—	—	—	—	—	—	—
Nitrik Asit% 50 / Nitric Acid - 50%	R	NR	—	—	R	R	R	R
Nitrik Asit - Tütsülenmiş / Nitric Acid - Fuming	R	R	R	R	—	—	—	—

**MALZEME UYGUNLUK KODU
MATERIAL SUITABILITY CODE**

R = Tavsiye edilir/Recommended
NR = Tasviye Edilmez/Not Recommended
Q = Kuşkuolu/Questionable
— = Bilgi Mevcut değil/No Available Information

KİMYASALIN ADI CHEMICAL NAME	STANDART MALZEMELER/STANDARD MATERIALS							
	PP		PE		POM		PP <small>Isıya Dayanıklı Heat Resistant</small>	
	(21 °C)	(60 °C)	(21 °C)	(60 °C)	(21 °C)	(60 °C)	(21 °C)	(60 °C)
Zeytinyağı / Olive Oil	R	R	R	R	—	—	Q	—
Oksalik Asit / Oxalic Acid	NR	NR	—	—	—	—	R	R
Oksijen / Oxygen	NR	NR	Q	NR	—	—	Q	Q
Ozon / Ozone	R	R	R	R	—	—	R	R
Palmitik Asit -% 70 / Palmitic Acid - 70%	R	R	—	—	—	—	—	—
Fıstık Yağı / Peanut Oil	R	R	R	R	—	—	—	—
Perklorik Asit -% 20 / Perchloric Acid - 20%	NR	NR	NR	NR	—	—	Q	NR
Perchloroethylene / Perchloroethylene	R	R	R	R	—	—	—	—
PhenolPhathalic Asit -% 50 / PhenolPhathalic Acid - 50%	R	R	R	R	NR	NR	NR	NR
Fenol -% 5 / Phenol - 5%	R	R	R	R	NR	NR	NR	NR
Fosforik Asit% 30 / Phosphoric Acid - 30%	R	R	R	R	—	—	NR	NR
Fosforik Asit% 85 / Phosphoric Acid - 85%	R	R	R	R	—	—	NR	NR
Fotografik Çözümler / Photographic Solutions	R	R	R	R	—	—	R	—
Kaplama Çözümleri / Plating Solutions	R	R	R	R	—	—	—	—
Potasyum Bileşikleri / Potassium Compounds	R	R	R	R	—	—	R	—
Potasyum Hydroxide / Potassium Hydroxide	R	R	R	R	—	—	R	—
Potasyum Lodide (% 3 Lodide) / Potassium Lodide (3% Lodide)	R	R	R	R	—	—	—	—
Potasyum / Potassium	R	Q	R	R	—	—	NR	NR
Permanganat / Permanganate	R	R	—	—	—	—	—	—
Siyanür Gümüş / Silver Cyanide	R	R	R	R	—	—	—	—
Gümüş Nitrat / Silver Nitrate	R	R	R	R	—	—	Q	—
Sodyum Bileşikleri / Sodium Compounds	R	Q	R	R	—	—	Q	NR
Sodyum Klorit / Sodium Chlorite	R	R	R	R	—	—	R	NR
Sodyum Hidroksit / Sodium Hydroxide	R	R	R	R	R	R	R	NR
Sodyum Hidroksit -% 60 / Sodium Hydroxide - 60%	R	Q	—	—	NR	NR	NR	—
Kalaysı Klorür / Stannic Chloride	R	R	R	R	—	—	—	—
Kalay Klorür / Stannous Chloride	R	R	R	R	—	—	—	—
Stearik Asit / Stearic Acid	R	Q	R	R	—	—	R	R
Süksinik Asit / Succinic Acid	R	R	R	R	—	—	—	—
Şeker / Sugar	R	R	R	R	—	—	—	—
Sülfamik Asit -% 20 / Sulfamic Acid - 20%	R	R	—	—	NR	NR	—	—
Sülfat Likörler / Sulfate Liquors	R	R	—	—	—	—	—	—
Kükürt / Sulfur	R	R	R	R	—	—	R	R
Kükürt Klorür / Sulfur Chloride	R	—	—	—	—	—	—	—
Kükürt Dioksit / Sulfur Dioxide	R	R	R	R	—	—	R	Q
Sülfürik Asit -% 3 / Sulfuric Acid - 3%	R	R	R	R	R	R	NR	NR
Sülfürik Asit - 50% / Sulfuric Acid - 50%	R	R	R	R	NR	NR	NR	NR
Sülfürik Asit - 70% / Sulfuric Acid - 70%	R	Q	R	Q	NR	NR	NR	NR
Sülfürik Asit - Tütsülenmiş / Sulfuric Acid - Fuming	NR	NR	NR	NR	NR	NR	NR	NR
Sülfirik Asit / Sulfurous Acid	R	—	R	R	—	—	Q	Q
Donyağı / Tallow	R	R	R	Q	—	—	R	R
Tannik Asit -% 10 / Tannic Acid - 10%	R	R	R	R	—	—	—	—
Tartarik Asit / Tartaric Acid	R	R	R	R	—	—	Q	Q
Tetrahidrofuran / Tetrahydrofuran	Q	NR	—	—	—	—	R	—
Toluene / Toluen	NR	NR	NR	NR	Q	NR	R	R
Domates Suyu / Tomato Juice	R	R	R	R	—	—	—	—
Trafo Yağı / Transformer Oil	R	Q	R	Q	—	—	R	R
Tributyl Fosfat / Tributyl Phosphate	R	Q	—	—	—	—	—	—
Trikloroasetik Asit / Trichloroacetic Acid	R	R	—	—	—	—	R	NR
Trikloroetilen / Trichloroethylene	NR	NR	NR	NR	—	—	R	NR
Tricresyl Fosfat / Tricresyl Phosphate	R	Q	—	—	—	—	—	—
Trisodyum Fosfat / Trisodium Phosphate	R	R	R	R	—	—	—	—
Terebentin / Turpentine	Q	NR	Q	NR	—	—	R	R
Üre / Urea	R	R	R	R	—	—	R	R
Sirke / Vinegar	R	R	R	R	—	—	—	—
Şarap / Wine	R	R	R	R	—	—	R	R
Ssilen / Xylene	NR	NR	NR	NR	—	—	R	R
Çinko Bileşikleri / Zinc Compounds	R	R	R	R	—	—	Q	—



Gültekinöğlü
Şirketler Öbeği/Corporation



ÇAĞRI[®]
ENDÜSTRİ A.Ş.

ALHAN[®]

MARKASIYLA ÜRETİM YAPMAKTADIR/TRADE MARK
www.alhan-cagri.com info@alhan-cagri.com

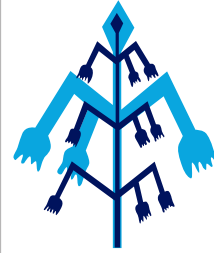
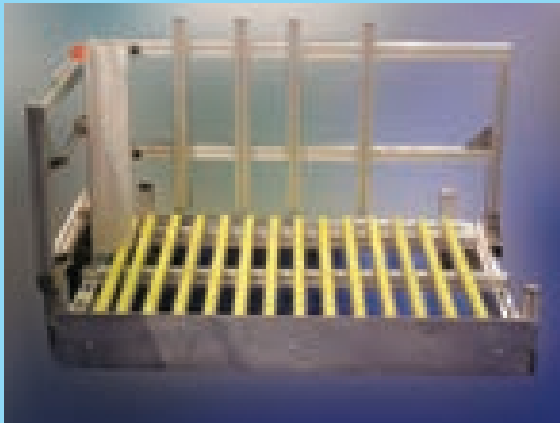

SATUK
BUĞRAHAN[®]
MAKİNE[®]
LTD. ŞTİ.

www.satukbugrahan.com
info@satukbugrahan.com
www.konveyorsistemleri.com

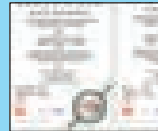
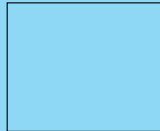
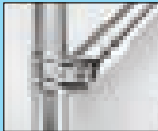

www.dinamikraflama.com



Bu katalog teknik bilgiler içeren bir dökümandır. Hiçbir surette ticari olarak kullanılmaz.
T.C.'nin ilgili yasalarından dolayı kanuni hakkımız saklıdır!
This catalogue includes technical information. It will never be used for trading purpose.
As a result of T.C. laws, our justice is secret!



ÇAĞRI[®]
ENDÜSTRİ A.Ş.

ALHAN[®]

YETKİLİ SATICI/DİSTİRİBÜTÖR

Davutpaşa Cad. Nu: 14/1

34010 Topkapı - İSTANBUL - TÜRKİYE

Tel: +90 212 444 00 42 - 544 50 55

Belgegeçer (Fax): +90 212 567 14 16 - 501 54 08

e-posta (e-mail) : info@alhan-cagri.com

www.alhan-cagri.com

