



**ÇAĞRI**<sup>®</sup>  
ENDÜSTRİ A.Ş.

**ALHAN**<sup>®</sup>

KONVEYÖR PARÇALARI ve MODULAR HASIR BANTLAR  
CONVEYOR COMPENENTS & MODULAR PLASTIC BELTS



**2018**

Tanıtıcı Belge (Broşür)

[www.alhan-cagri.com](http://www.alhan-cagri.com)



MADE IN TURKEY

Üretimden Satış  
From Production to Sales



444 00 42

SERTİFİKA \* ZERTİFİKAT \* CERTIFICATE \* СЕРТИФИКАТ



## KALİTE YÖNETİMİ

### QUALITY MANAGEMENT

**ÇAĞRI ENDÜSTRİ MALLARI PAZARLAMA YATIRIM SANAYİ VE TİCARET A.Ş.**

kuruluşun,  
company,

Davutpaşa Cad. No: 14 Kat: 2 Topkapı / İstanbul / Türkiye  
at address,

KONVEYÖR PARÇALARI, MÜHENDİSLİK PLASTİKLERİ VE MAKİNE ELEMENLARI TASARIM, ÜRETİM, SATIŞI DESIGN, PRODUCTION AND SALES OF CONVEYOR PARTS, MACHINE ELEMENTS AND ENGINEERING PLASTICS

kalite yönetim sistemi yürürlüğe koyduğu,  
perform the quality management system,

### ISO 9001:2015

standart taleplerinin yerine getirildiği belirlenmiştir.  
the complete of the standard was determined,

İlk Yayın Tarihi / Date First Registered : 02.03.2010  
Yayın Tarihi / Date Certificate Issued : 23.02.2018  
Geçerlilik Periyodu / Period of Registration : 3 Yıl / Years  
Geçerlilik Tarihi / Date Certificate Expires : 22.02.2019  
Sertifika Numarası / Certificate No : 01/10077/09

Onay:  
Approver:





Bu sertifikanın geçerliliği, yılda en az bir kez yapılacak gözlem denetiminin başarıyla gerçekleşmesiyle sağlanır.  
The Validity of this certificate, subject to successful completion of surveillance audit which will take place at least once a year.

ASB Uluslararası Belgelendirme Gözetim Denetim ve Eğitim Hiz. Ltd. Şti. / ASB International Certification Surveillance, Auditing and Training Services Ltd. Company  
Tatlısu Mh. Akıl İnan Sok. Servim Residence No:16 Daire:13 Kat:06 Ümraniye - İstanbul / TÜRKİYE. Tel: +90 216 526 10 04 Fax: +90 216 526 30 91 e-mail: bilgi@asbcert.com  
- Bu sertifika, kuruluşa un ASB'nin şartlarına uyduğu sürece geçerlidir. Sertifikanın durumu: www.asbcert.com.tr adresinden kontrol edilebilir.  
The Validity shall remain in force as long as the corporation follows instructions of ASB. Certificates status can be checked at www.asbcert.com.tr



T.C.  
TÜRK PATENT ENSTİTÜSÜ

### MARKA TESCİL BELGESİ

Marka No: 201141  
Çağrı Ticaret



Marka Sahibi: ÇAĞRI ENDÜSTRİ MALLARI PAZARLAMA YATIRIM SANAYİ VE TİCARET ANONİM ŞİRKETİ  
Ticaret Sicil No: 274561  
Adres: Halkapınar, Etiler Mahallesi, Kat: No:22 BAYRAMPAŞA İSTANBUL  
Etiler / Beşiktaş / İstanbul / Türkiye

Markaların Korunması Hakkında 506 Sayılı Kanun Hükmünde Kararnameye göre 30/03/1998 Tarihinden İtibaren ON YIL müddetinde koruma süresindedir.

T.C. YENİLENEBİLİR ENERJİ BAKANLIĞI

Marka tescil belgesi  
Brand registration certificate



T.C.  
TÜRK PATENT ENSTİTÜSÜ

### MARKA TESCİL BELGESİ

Marka No: 200215474  
Çağrı Model



Marka Sahibi: ÇAĞRI ENDÜSTRİ MALLARI PAZARLAMA YATIRIM SANAYİ VE TİCARET ANONİM ŞİRKETİ  
Ticaret Sicil No: 274561  
Adres: Halkapınar, Etiler Mahallesi, Kat: No:22 BAYRAMPAŞA İSTANBUL  
Etiler / Beşiktaş / İstanbul / Türkiye

Markaların Korunması Hakkında 506 Sayılı Kanun Hükmünde Kararnameye göre 24/06/2002 Tarihinden İtibaren ON YIL müddetinde koruma süresindedir.

T.C. YENİLENEBİLİR ENERJİ BAKANLIĞI

Endüstriyel tasarım tescil belgesi  
Registration certificate of industrial design



T.C.  
TÜRK PATENT ENSTİTÜSÜ

### ENDÜSTRİYEL TASARIM TESCİL BELGESİ

Tescil No: 2002 02347  
TEKİL

Tasarım Sahibi: ÇAĞRI ENDÜSTRİ MALLARI PAZARLAMA YATIRIM SANAYİ VE TİCARET ANONİM ŞİRKETİ  
Ticaret Sicil No: 274561  
Adres: Halkapınar, Etiler Mahallesi, Kat: No:22 Davutpaşa İSTANBUL  
Etiler / Beşiktaş / İstanbul / Türkiye

Endüstriyel Tasarımın Korunması Hakkında 504 Sayılı Kanun Hükmünde Kararnameye göre 06/06/2002 Tarihinden itibaren ON YIL müddetinde koruma süresindedir.

T.C. YENİLENEBİLİR ENERJİ BAKANLIĞI

Endüstriyel tasarım tescil belgesi  
Registration certificate of industrial design



T.C.  
TÜRK PATENT ENSTİTÜSÜ

### FAYDALI MODEL BELGESİ

No: TR 2003 00089 Y

Bu belge, 551 sayılı Patent Hükümlerine Kurumun Hakkında Kanun Hükmünde Kararnameye'nin 162 nci maddesi kapsamında 27/06/2003 Tarihinden itibaren 10 yıl süre ile korunmaktadır.

T.C. YENİLENEBİLİR ENERJİ BAKANLIĞI



**ОРГАН ПО СЕРТИФИКАЦИИ ПРОДУКЦИИ  
ОБЩЕСТВО С ОГРАНИЧЕННОЙ ОТВЕТСТВЕННОСТЬЮ  
"СЕРКОНС"**

Аттестат аккредитации: № РОСС RU.0001.11AB28  
115114, Москва, ул. Дербеневская наб., д. 11, пом. 60, Россия.  
Тел.: +7 (495) 782 1708, факс: +7 (495) 782 1701.  
Сайт: www.serconrus.ru, e-mail: info@serconrus.com

Исх. № 01-11/1815 от 19.06.2014г.

**"ÇAĞRI ENDÜSTRİ MALLARI  
PAZARLAMA YATIRIM SANAYİ VE  
TİCARET A.Ş."**

Адрес: Davutpaşa Caddesi No.14/1 34010  
Topkapı-İSTANBUL/Турция

Информационное письмо.

Орган по сертификации продукции ООО «СЕРКОНС» (аттестат аккредитации № РОСС RU.0001.11AB28) информирует Вас о том, что в соответствии с Постановлением Правительства РФ от 1 декабря 2009 г. N 982 «Об утверждении единого перечня продукции, подлежащей обязательной сертификации, и единого перечня продукции, подтверждение соответствия которой осуществляется в форме принятия декларации о соответствии», введенным в действие с 15.02.2010 г. указанная ниже продукция, **не подлежит** подтверждению соответствия, а так же **не является** объектами обязательного подтверждения соответствия по техническому регламенту Таможенного союза «О безопасности машин и оборудования» (ТР ТС 010/2011), утвержденного Решением Комиссии Таможенного союза от 18.10.2011 N 823:

Наименование продукции	Код ОКП, ТН ВЭД
Конвейерные элементы и ленты п.м. "ALHAN"	8431 39 000 0

Оформление сертификата соответствия и принятие декларации о соответствии не требуется.

Руководитель ООС  А. А. Григорьев

СИСТЕМА СЕРТИФИКАЦИИ ГОСТ Р  
ФЕДЕРАЛЬНОЕ АГЕНТСТВО ПО ТЕХНИЧЕСКОМУ РЕГУЛИРОВАНИЮ И МЕТРОЛОГИИ



### СЕРТИФИКАТ СООТВЕТСТВИЯ

№ РОСС TR.MM.04.H04168  
Срок действия с 19.06.2014 по 18.06.2017  
№ 1627188

ОРГАН ПО СЕРТИФИКАЦИИ рег. № РОСС RU.0001.11MM04 Орган по сертификации продукции ООО "ПТЛ Стэндуарт и Качество" РФ, 115114, г. Москва, Дербеневская наб., д. 11, помещение 60. Телефон (495)777-80-28, факс (495)777-80-28, адрес электронной почты zakaz@nto-sk.ru.



ПРОДУКЦИЯ Конвейерные элементы и ленты т.м. «ALHAN» (см. приложение на 1 листе, бланк № 0521109).  
Серийный выпуск: 31 6900

СООТВЕТСТВУЕТ ТРЕБОВАНИЯМ НОРМАТИВНЫХ ДОКУМЕНТОВ  
ГОСТ 12.2.003-91 код ТН ВЭД Россия: 8431 39 000 0

ИЗГОТОВИТЕЛЬ «ÇAĞRI ENDÜSTRİ MALLARI PAZARLAMA YATIRIM SANAYİ VE TİCARET A.Ş.»  
Адрес: Davutpaşa Caddesi No 14/1 34010 Topkapı-İSTANBUL, Турция.  
Телефон (+90 212)444 00 42, факс (+90 212)501 54 08.  
СЕРТИФИКАТ ВЫДААН «ÇAĞRI ENDÜSTRİ MALLARI PAZARLAMA YATIRIM SANAYİ VE TİCARET A.Ş.»  
Адрес: Davutpaşa Caddesi No 14/1 34010 Topkapı-İSTANBUL, Турция.  
Телефон (+90 212)444 00 42, факс (+90 212)501 54 08.

НА ОСНОВАНИИ протокола сертификационных испытаний № 11066 от 18.06.2014 г.  
Испытательный центр ООО «АКАДЕМСКИЙ» аттестат аккредитации № РОСС RU.0001.21AB09 от 01.08.2011 до 01.08.2016, адрес: 630024, Новосибирская обл., г. Новосибирск, ул. Бегонная, д. 14

ДОПОЛНИТЕЛЬНАЯ ИНФОРМАЦИЯ Сертификат системы менеджмента качества ISO 9001:2008 № 01/10077/05-TR от 27.02.2014 г., выданный ОС «ASB»  
Срок действия: 3.

Руководитель органа  П.П. Филатов  
Эксперт  Б.П. Чумаченко

Сертификат не применяется при обязательной сертификации



ÇAĞRI

ENDÜSTRİ A.Ş.

ALHAN





**ÇAĞRI**<sup>®</sup>  
ENDÜSTRİ A.Ş.

**ALHAN**<sup>®</sup>

[www.alhan-cagri.com](http://www.alhan-cagri.com)

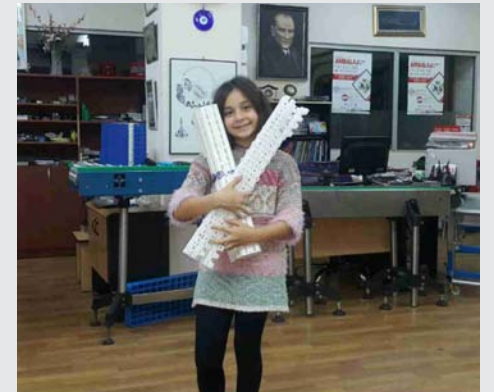

“Ey yükselen yeni nesil, gelecek sizindir. Cumhuriyeti biz kurduk; onu yükseltecek ve sürdüreceksiniz.”

*H. Atatürk*

Üretimden Satış / From Production to Sales







## Tarihçe / History

**ÇAĞRI ENDÜSTRİ A.Ş.**, 1978 yılında Gültekinoğlu Sâlih Özbideciler tarafından İstanbul'da kurulmuş olup 1994 yılından itibaren konveyör modüler (hasır) bantları ve hazır makine parçalarını üretmektedir. **ALHAN**® markasıyla üretim yapmaktayız.

**CAGRI IND. INC.** was founded in 1978 in Istanbul, Turkey. Our company is leading manufacturer of modular belts and conveyor components since 1994. Our trade mark is "**ALHAN**®"



## Sektörler / Sectors

Gıda Sektörü  
Food Industry



Otomotiv Sektörü  
Automotive Industry



Et Ürünleri Sektörü  
Meat Products Sector



İlaç Sektörü  
Pharmaceutical Industry



Süt Ürünleri Sektörü  
Dair Products Sector



Sebze Meyve Sektörü  
Fruit and Vegetable Sector



Meşrubat ve Konserve Sektörü  
Soft Drinks and Canned



Deniz Sektörü  
Sea Products Sector





**Düşük Sürtünmeli Asetal/Low Friction Acetal (LF)**

Termoplastik grubundan olan bu malzeme düşük sürtünme katsayısı ve yüksek gerilme değerlerine sahiptir. Dönüştürülebilir ve düz konveyör bantlarında kullanılan bu malzemenin gıdaya uygunluk belgesi bulunmaktadır.

This is a thermoplastic material with special additives providing low coefficients and high tensile strength. This material's specific components make it ideally suited for use in curved-route chains. Material with certificate FDA.

**Asetal/Acetal(D)**

Oldukça yüksek mekanik özelliklere sahiptir. İçerik olarak herhangi bir katkı maddesi bulunmamakla birlikte gıdaya uygunluk sertifikası bulunmaktadır.

This thermoplastic has extremely good mechanical properties. It is used without any special additives. Material with certificate FDA.

**Güçlendirilmiş Polipropilen/Reinforced Polypropylene (PP+FV)**

Cam elyaf katkılı polipropilendir. Kimyasallara karşı dayanımı yüksektir.

Fibre-glass reinforced polypropylene. This material is highly resistant to chemical agents.

**Polyamid/Polyamide(PA6)**

Yüksek gerilme özelliğine sahip olan bu malzemenin ses azaltıcı özelliği bulunmaktadır.

This material has high tenacity and good noise absorption polyamide.

**Güçlendirilmiş Polyamid/Reinforced Polyamide**

Cam elyaf katkılı olan bu malzemenin mekanik ve ısıl özellikleri artırılmıştır.

Polyamide variant with mechanical and thermal properties improved.

**Alpolen®UHMW**

Yüksek moleküler ağırlığa sahip olan alpolen düşük sürtünme katsayısı ile sürtünme profilleri ve zincir kızıkları elemanlarında kullanılmaktadır. Gıdaya uygunluk sertifikası bulunmaktadır.

The ultra high molecular weight alpolen is the material more used in friction applications in view of its piece-quality relation. It can be used in sliding guides and friction profiles.

**PBT**

Normal şartlar altında su geçirgenliği neredeyse sıfır olan bu malzemenin mekanik ve ısıl özellikleri de oldukça yüksektir. Daha çok rulman yataklarında kullanılmaktadır.

It has high water absorption furthermore good mechanical and thermal properties.

**Katalogtaki ürünlerin tasarımları değişikliğe uğrayabilir ve değişiklikten doğabilecek sorunlardan firmamız sorumlu değildir. In catalogue, our product's design will be changed and as a result of this we have no response.**



805



Çift Mentşeli  
Paslanmaz Bantlar  
Double Hinges Plastic Chains

810



Düzgün Doğrusal  
Paslanmaz Çelik Bant  
Stainless Chains

815



Düzgün Doğrusal  
Paslanmaz Çelik Bant  
Stainless Chains

815 G



Kauçuk Bantlı  
Paslanmaz Kulaksız Bant  
Stainless Chains

808 RUL



Makaralı Zincir Bantı  
Roller Chains

881 A



Açılı Kulaklı  
Dönüşlü Paslanmaz Bant  
Plate Chains for Curved Conveyor

881 T



TAB Kulaklı Dönüşlü  
Paslanmaz Bant  
Plate Chains for Curved Conveyor

881 M



Manyetik Dönüşlü  
Paslanmaz Bant  
Plate Chains for Curved Conveyor

350 TI2



İki Parçalı Düzgün Doğrusal Paslanmaz  
Bant Tahrik Dişlisi (Talaşlı İmalat)  
Split Sprockets

380 825



Paslanmaz Dönüşlü Bant Tahrik Dişlisi  
Split Sprockets

371 KDT



TAB Kulaklı Dönüşlü Paslanmaz  
Bant Dişlisi (Talaşlı İmalat)  
Split Sprockets

328 KI1



Z19 Plastik Tek Parça  
Bant Tahrik Dişlisi  
Split Sprockets

871



Düzgün Doğrusal 30 mm  
Asetal Bakla Bant  
Plate Chains

374 015



30'luk Asetal Bakla Bant  
Dişlisi (TV Bantı-Talaşlı İmalat)  
Driving Sprockets

821



Düzgün Doğrusal Ağır Tip Çift  
Menteşeli Asetal Bakla Bant  
Double Hinges Chains

395 CMT

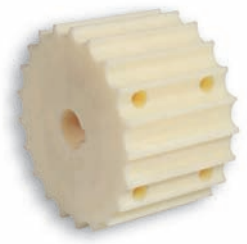

Çift Mentşeli Asetal ve Paslanmaz  
Bant Dişlisi (İki Parçalı-Talaşlı İmalat)  
Split Sprockets



820



Düzensiz Doğrusal Bakla Bant  
Straight Plate Chains

880 TGO



Tırnaklı Manyetik  
Dönüşlü Bant  
Plate Curved for Curved Conveyor

880 TBG



TAB Kulaklı Dönüşlü Bant  
Plate Curved for Curved Conveyor

880 TGT



Tırnaksız Manyetik Dönüşlü Bant  
Plate Curved for Curved Conveyor

882



Ağır Tip Tab Kulaklı  
Dönüşlü Bakla Bant  
Plate Curved for Curved Conveyor

304 021



Avare Kasnak  
Driving Sprockets

312 KI2



İki Parçalı Plastik  
Bant Tahrik Dişlisi  
Split Sprockets

314 KI2



İki Parçalı Paslanmaz Bant  
Tahrik Dişlisi  
Driving Sprockets

821 BPM



Boncuk Makaralı  
Düzensiz Doğrusal Bantlar  
Staringht Roller Chains

882 BPT



Boncuk Makaralı Dönüşlü Bantlar  
Curve Roller Chains

885 SKM

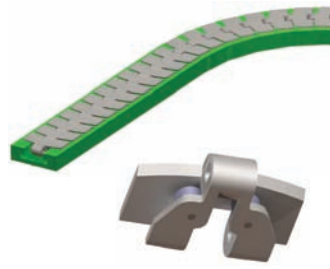

Boncuk Makaralı Bant  
Sideflexing Chain For Curver Conveyors

854



Kulaklı Kasa Taşıma Bantı  
Crate Conveyor Chains

320 TI2



İki Parçalı Plastik Bant  
Dişlisi (Talaşlı İmalat)  
Split Sprockets

386 KDT



Asetal Dönüşlü Bant  
Tahrik Dişlisi (Talaşlı İmalat)  
Split Sprockets

385 H25



Dönüşlü Plastik Bant Hafif-Ağır Tip  
Tek Parça Tahrik-Avare Dişlisi  
Light-Heavy Driving & Idler Sprocket

302 019



Avare Kasnak  
Idler sprockets

184 3GO



Asetal Zincir Bant  
Plate Top Chains with Base Roller Chains

1873



Asetal Zincir Bant  
Plate Top Chains with Base Roller Chains

1874



Asetal Zincir Bant  
Plate Top Chains with Base Roller Chains

843



Asetal Zincir Bant  
Plate Top Chains with Base Roller Chains

863 G00



Asetal Zincir Bant  
Plate Top Chains with Base Roller Chains

880 BYO



Yarasa Bant (Düz Kulaklı)  
Plain Chains

881 BYO



Yarasa Bant (Silindir Kulaklı)  
Plain Chains

374 KDS



Silindir Kulaklı Yarasa Bant  
Dişlileri (Tek Parça-Talaşlı İmalat)  
Drive Sprockets for Flex Chains

863 GKO



Tırnaklı Kauçuk Bant  
Rubber Chains

853 B00



853 Kulaklı Kasa Taşıma  
Bantı (Ağır Tip)  
Crate Chains (Heavy Type)

854 B00



854 Kasa Taşıma  
Götürücülü Bantı (Ağır Tip)  
Crate Chains (Heavy Type)

857 B00



857 Düz Kasa  
Taşıma Bantı  
Crate Chains

858 B00



858 Kulaklı Kasa  
Taşıma Bantı  
Crate Chains

859 B00



859 Kasa Taşıma  
Götürücülü bantı  
Crate Chains

380 D....



Kasa Taşıma Bantı Dişlisi  
Sprocket for crate chains

853 D....



Kasa Taşıma Bantı Dişlisi  
Sprocket for crate chains



**860 BOO**



860 Kulaklı (Kardenik)  
Omurgalı Bant  
Cardanic Chains

**865 BOO**



865 Kulaksız (Kardenik)  
Omurgalı Bant  
Cardanic Chains

**870 BOO**



870 Kulaksız (Kardenik)  
Omurgalı Bant  
Cardanic Chains

**875 BOO**



875 Kulaksız (Kardenik)  
Tırnaksız Omurgalı Bant  
Cardanic Chains

**876 BOO**



876 Kulaksız (Kardenik)  
Alt Tırnaklı Omurgalı Bant  
Cardanic Chains

**867 BOO**



867 Kulaksız Omurgalı  
Götürücülü Bant  
Cardanic Conveyor Chains

**318 T25**



Kardenik Bant Avare Dişlisi  
Drive Sprockets

**338 T25**



Kardenik Bant Tahrik Dişlisi  
Split Sprockets

**941 B01**



50,8 Dönüslü Hasır Bant  
Spiral conveyor belts sprockets

**381 ABB**



50,8 Dönüslü Hasır  
Bant Dişlisi  
Split Sprockets

**946**

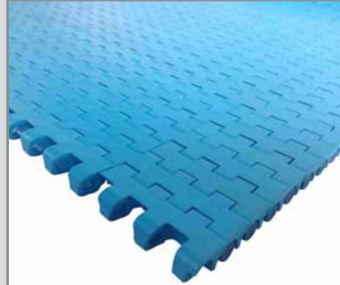

12,7 Hasır Bant  
Modular Conveyor Belts

**388**



12,7 Hasır Bant Dişlisi  
Modular Belts Driving Sprockets

**940 B01**

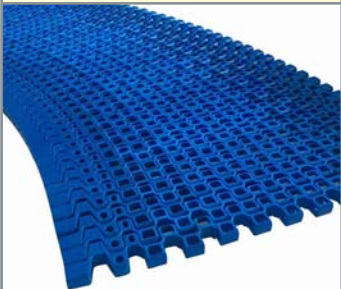

25,4 Dönüslü Hasır Bant  
Spiral conveyor belts

**380 ABB**



25,4 Dönüslü Hasır  
Bant Dişlisi  
Split Sprockets

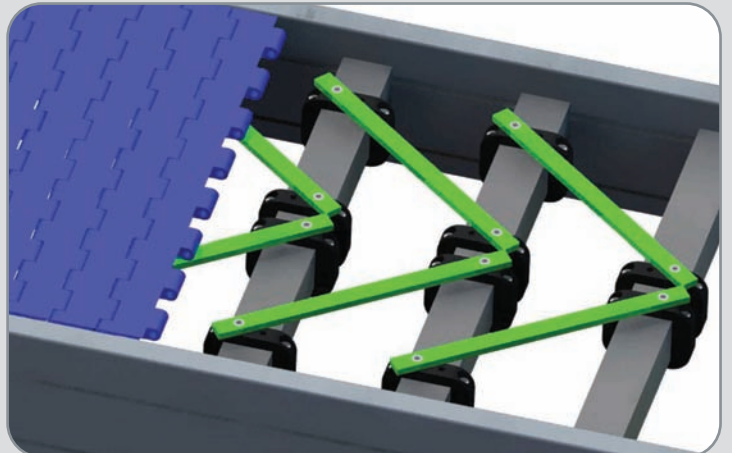

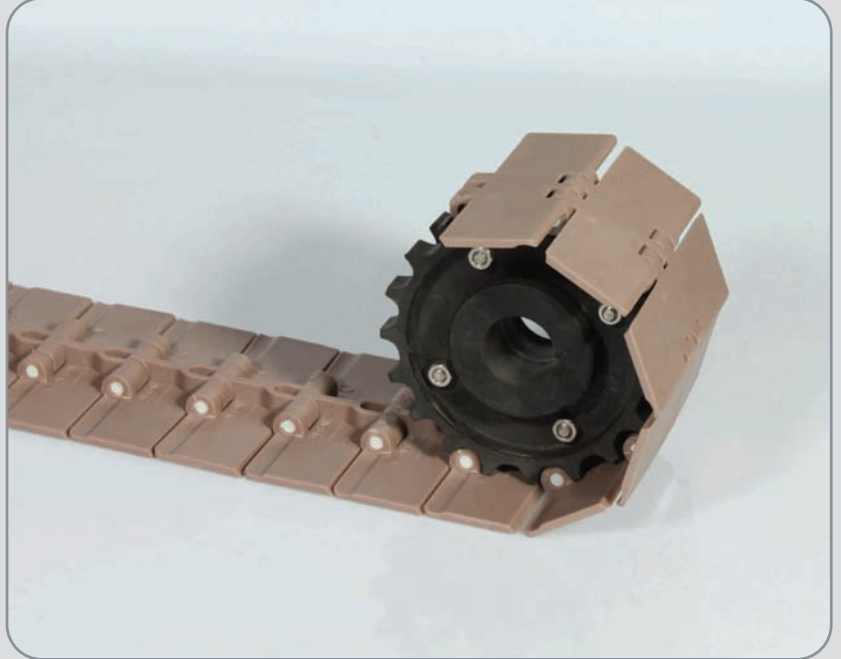
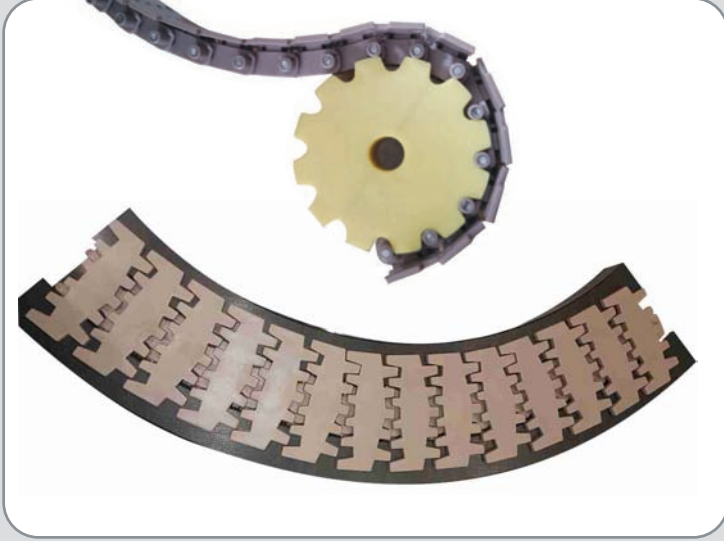



910

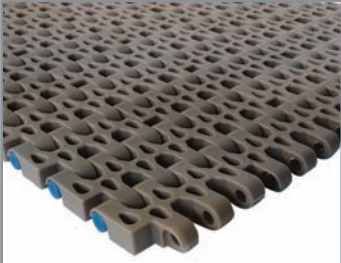

25,4 Damla Süzgeçli  
Hasır Bant  
Locked Drop Filter Modular Belt

361



25,4 Damla Süzgeçli  
Hasır Bant Dişlisi  
Split Sprockets

920

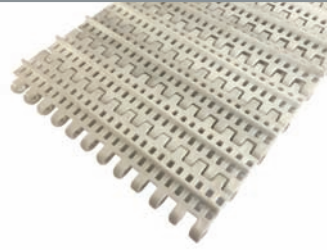

25,4 Kolay Temizlenebilir  
Tırnaklı Hasır Bant  
25,4 Easy to Clean Conveyor Belts

921

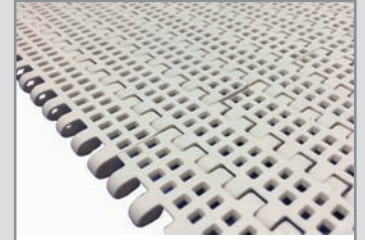

25,4 Küçük Süzgeçli Kolay  
Temizlenebilir Hasır Bant  
25,4 Easy to Clean Conveyor Belts

922



25,4 Büyük Süzgeçli Kolay  
Temizlenebilir Hasır Bant  
25,4 Easy to Clean Conveyor Belts

923



25,4 Düz Kolay  
Temizlenebilir Hasır Bant  
25,4 Easy to Clean Conveyor Belts

391



25,4 Kolay Temizlenebilir  
Hasır Bant Dişlisi  
Easy to Clean Conveyor Driving Sprockets

927



25,4 Kilitli Düz Hasır Bant  
Locked Modular Conveyor Belts

931



25,4 Kilitli  
Süzgeçli Hasır Bant  
Locked Linear Filter Conveyor Belts

935

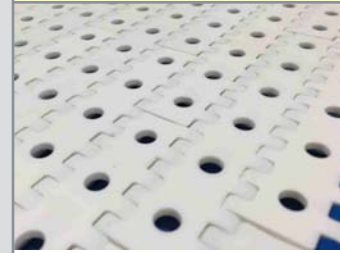

25,4 Kilitli Dairesel  
Süzgeçli Hasır Bant  
Locked Circular Filter Conveyor Belts

962



25,4 Kilitli  
Mazgalı Hasır Bant  
Open Grid Modular Conveyor Belts

822



25,4 Çok Mentşeli  
Hasır Bant  
Mold to Width

947

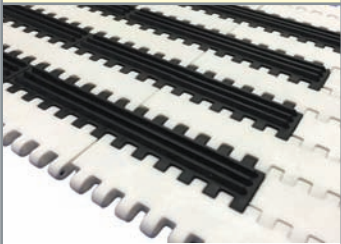

25,4 Hasır Bant için  
Kauçuk Götürücü  
Mini rubs rubber modular conveyor belts

937

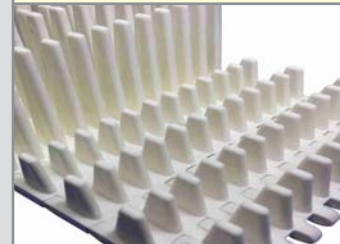

25,4 Hasır Bant  
için Taraklı Götürücü  
Cleats for modular conveyor belts

939

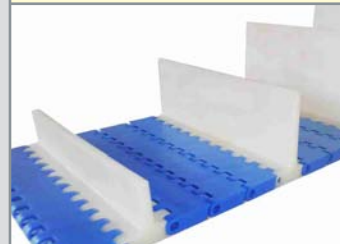

25,4 Hasır Bant için Götürücü  
Cleats for Modular Conveyor Belts

381



25,4 Hatve Bant Tahrik Dişlisi  
Split Sprockets

961

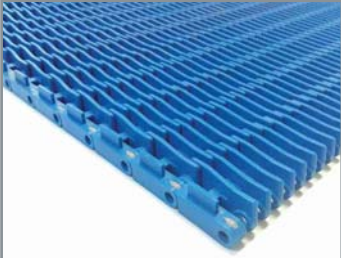

27,2 mm Hasırbant  
Yükseltilmiş Izgaralı (Süzgeçli)  
Raised Open Grid Modular Conveyor Belts

850

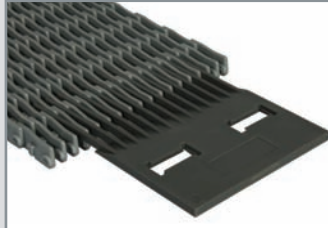

Geçiş Tarağı  
Transition Cradle

965



27,2 mm Hasırbant  
Izgaralı (Süzgeçli)  
Open Grid Modular Conveyor Belts

380 ABD



27,2 Hasır Bant Dişlisi  
27,2 Sprockets for Modular Belts

845



38,1 Hasır Düz Taşıma Bantı  
Modular Flat Top Conveyor Belts

862



38,1 Izgaralı  
(Süzgeç) Hasır Bant  
Grid Modular Conveyor Belts

831



38,1 Kaburga Kanallı  
Hasır Taşıma Bantı  
Raised Rip Modular Conveyor Belts

833



38,1 Kauçuk Hasır Bant  
Friction Top Chains (special series)

834



38,1 Hasır Bant  
Taraklı Götürücüsü  
Cleat Chains

855



38,1 Hasır Bant Götürücüsü  
Cleat Chains

850 C02



38,1 Bant Geçiş Tarağı  
Transfers Combs

326



Kalıplı 38.1 Hatve Hasır  
Bant Dişlisi (iki Parçalı)  
Split Sprockets

360 T12



38,1 Hasırbant Dişlisi  
(Talaşlı İmalat 2 parça)  
Driving Sprockets

952



50,8 Hasır Düz Taşıyıcı  
Bant (Ağır Tip)  
Modular Flat Top Conveyor Belts

954

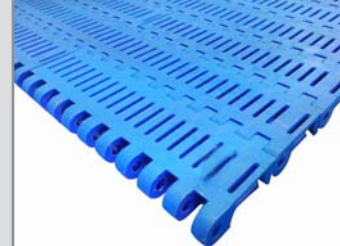

50,8 Hasır Süzgeçli  
Taşıyıcı Bant (Ağır Tip)  
Modular Flat Top Conveyor Belts

950



50,8 Yıldız Serisi Hasır  
Düz Taşıyıcı Bant (Ağır Tip)  
Star Serie Modular Conveyor Belts



963



50,8 Yumru Desenli  
Hasır Bant (Ağır Tip)  
Nub Top Modular Conveyor Belts

943

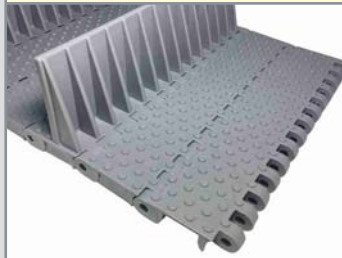

50,8 Engelli Götürücü  
(Ağır Tip)  
Cleat Chains

960

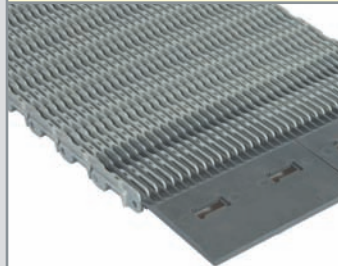

50,8 Kaburgalı Kanallı  
Hasır Bant (Ağır Tip)  
Raised Rip Modular Conveyor Belts

850

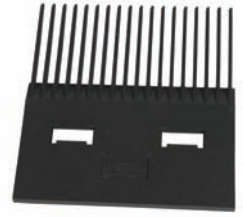

50,8 Hasır Bant  
Geçiş Tarağı  
Transfers Combs

956



50,8 Biriktirme  
Makaralı Hasır Bant  
Accumulation Roller Belts

957



50,8 Aktarma Makaralı  
Hasır Bant  
Transfer Roller Belts

382



Z16 Tahrik Dişlisi  
Split Sprockets

958

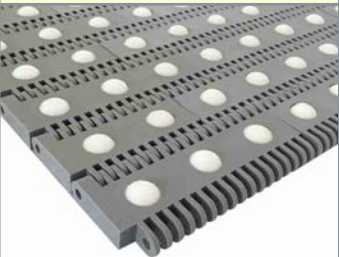

50,8 Dana Gözlü  
Hasır Bant  
Ball Modular Belts

383



Dana Gözlü Hasır Bant  
Split Sprockets

999 EKO



Taşıyıcı Kova  
Elevator Buckets

868 B01



Yan Kulak  
Side Guards

980

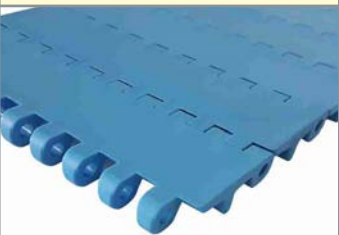

50,8 Kolay Düz  
Temizlenebilir Bant  
50,8 Easy to Clean Conveyor Belts

981



50,8 Süzgeçli Kolay  
Temizlenebilir Bant  
50,8 Easy to Clean Conveyor Belts

982

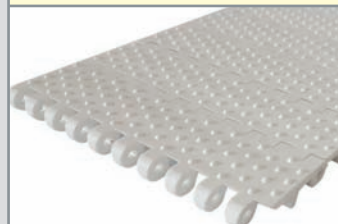

50,8 Yumru Desenli  
Kolay Temizlenebilir Bant  
50,8 Nub top Modular Conveyor Belts

983

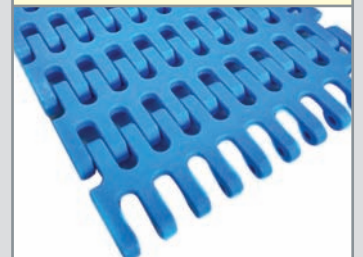

50,8 Izgaralı Kolay  
Temizlenebilir Bant  
50,8 Easy to Clean Conveyor Belts

984

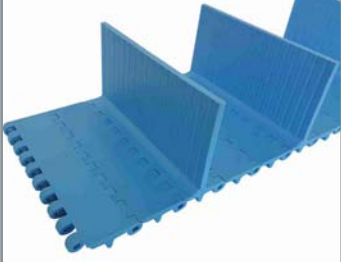

50,8 Götürücülü Kolay  
Temizlenebilir Bant  
50,8 Easy to Clean Conveyor Belts

389



50,8 Hatve Kolay Temizlenebilir  
Hasır Bant Dişlisi  
Easy to Clean Conveyor Driving Sprockets

800 167 077



Aktarma Tavası  
Modular Transfer Plates with Rollers

800 167 078



Aktarma Tavası  
Modular Transfer Plates with Rollers

800 167 070



Aktarma Tavası  
Modular Transfer Plates with Rollers

800 167 071



Aktarma Tavası  
Modular Transfer Plates with Rollers

800 167 072



Aktarma Tavası  
Modular Transfer Plates with Rollers

800 167 073



Aktarma Tavası  
Modular Transfer Plates with Rollers



800 235 040



Dişli Sabitleme  
Kelepçesi (Kare)  
Square

800 235 350



Dişli Sabitleme  
Kelepçesi (Yuvarlak)  
Circle

207 GYR

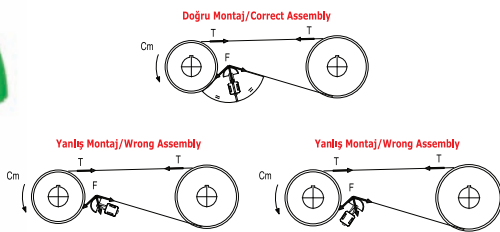

Zincir Gergi Aparatı  
Chain Tensioner

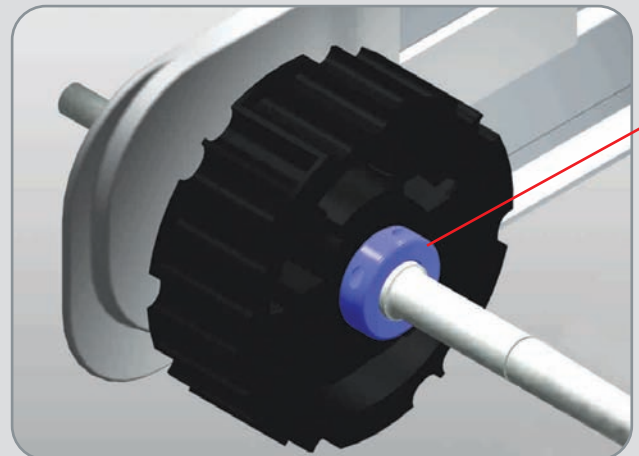



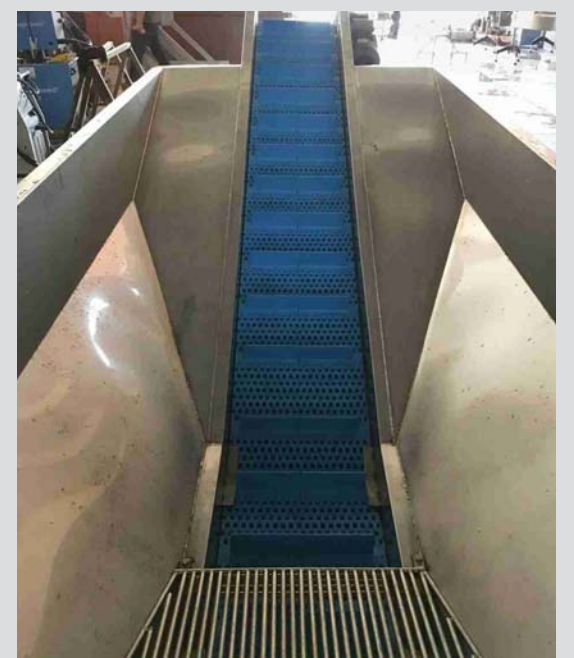
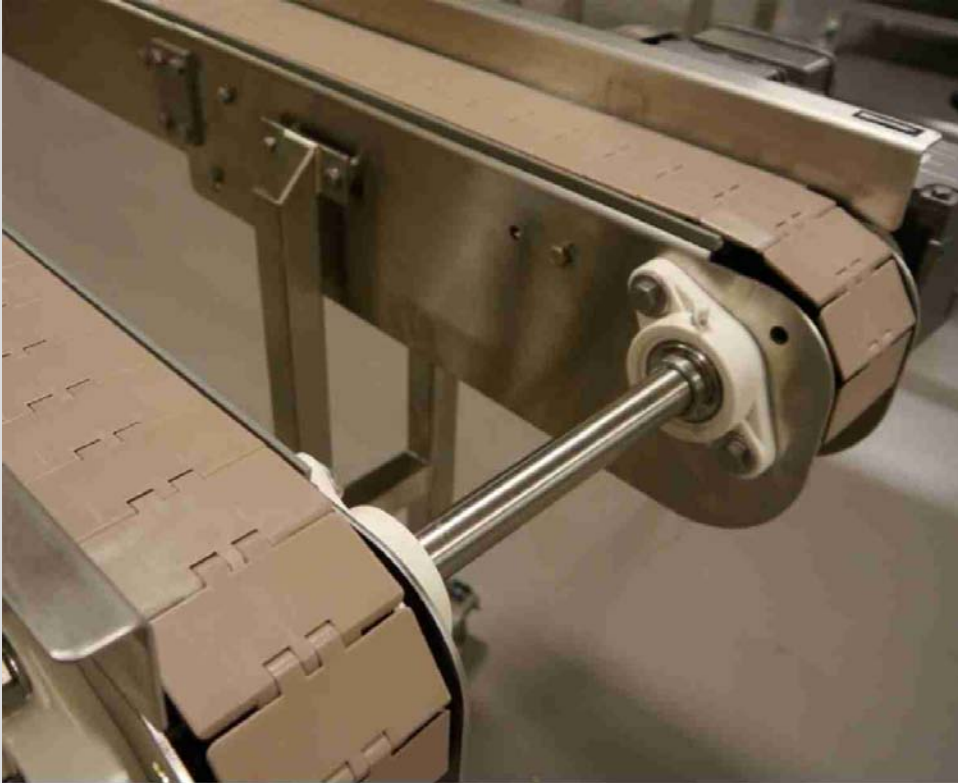
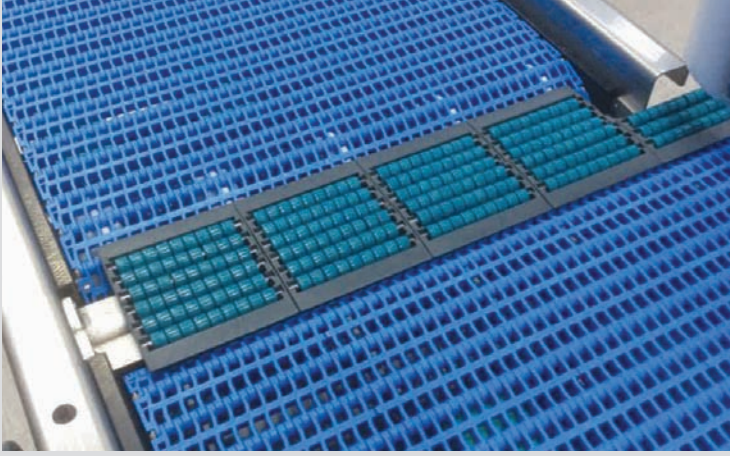



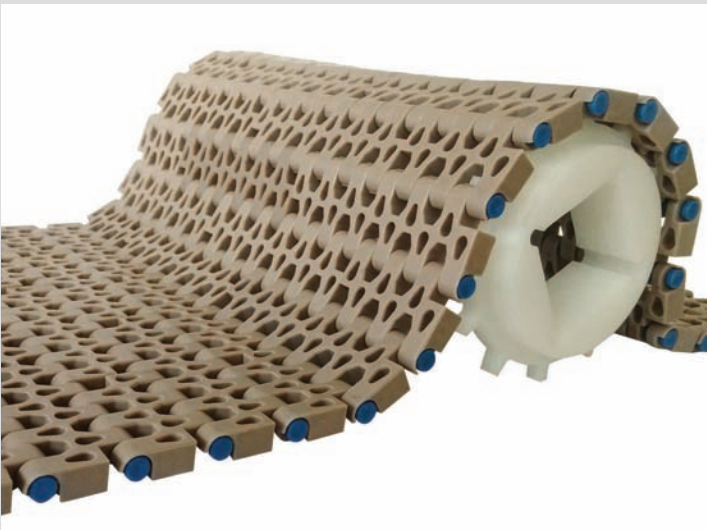
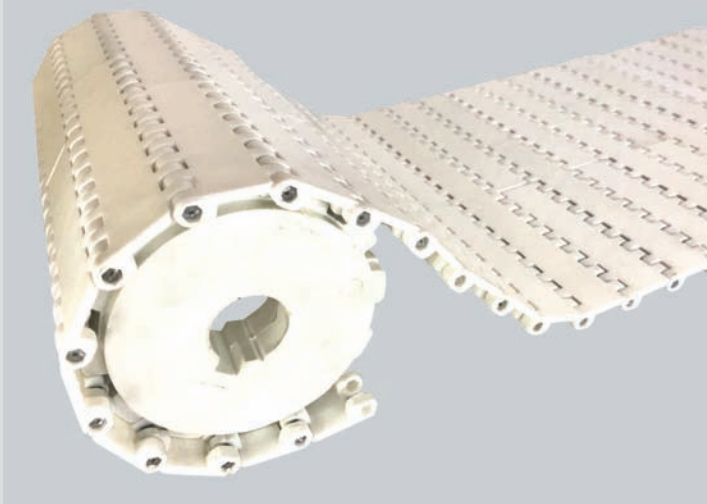
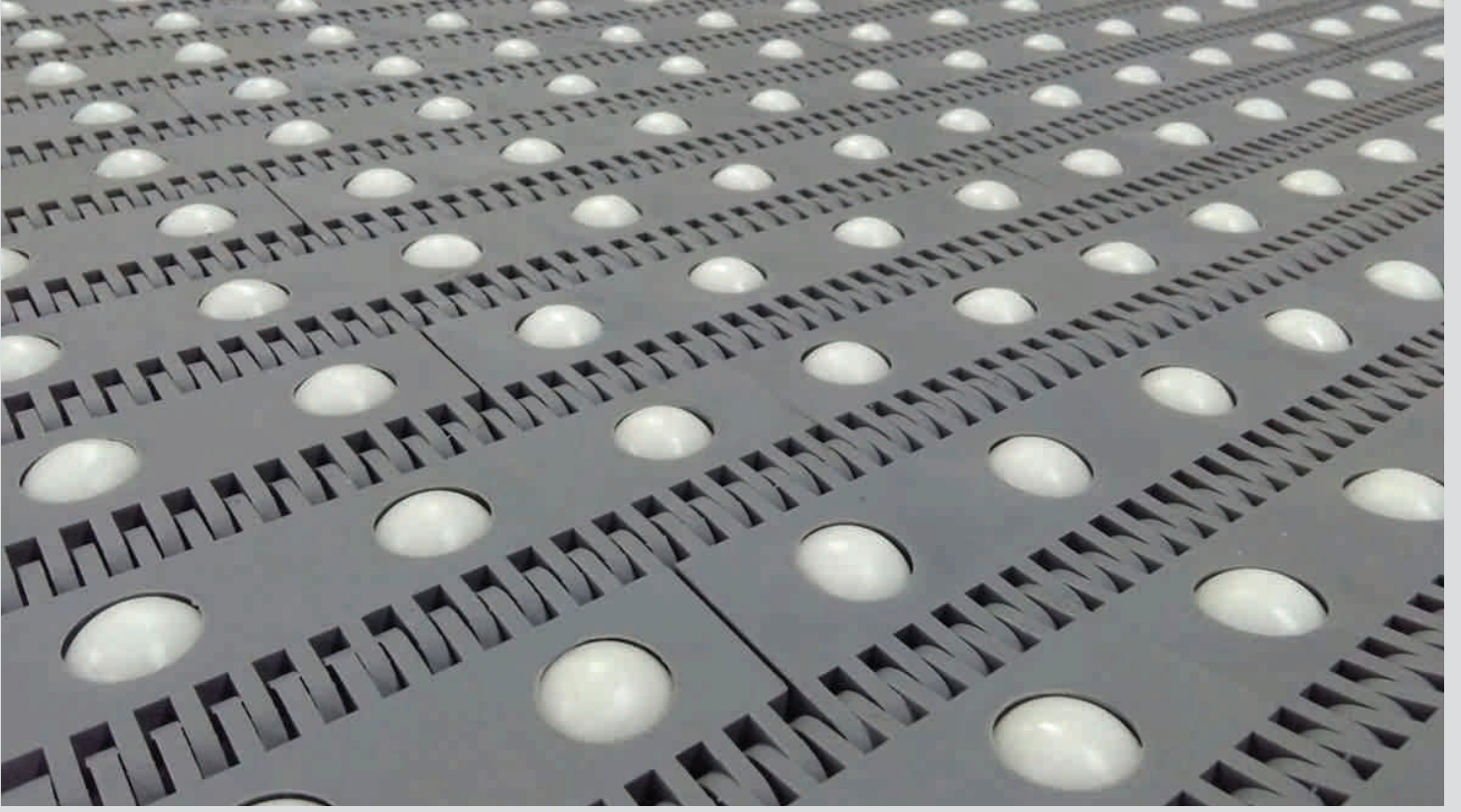



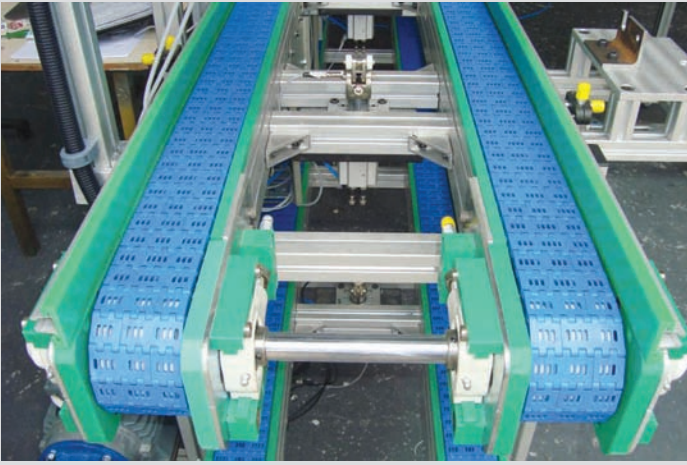
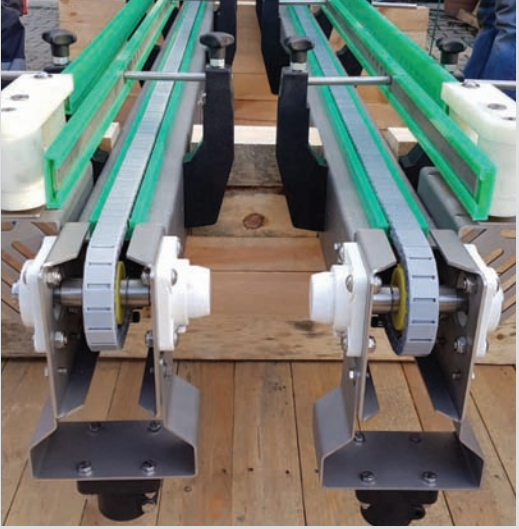



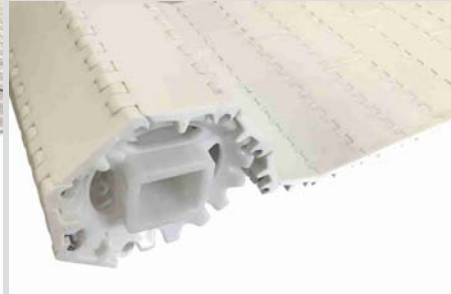
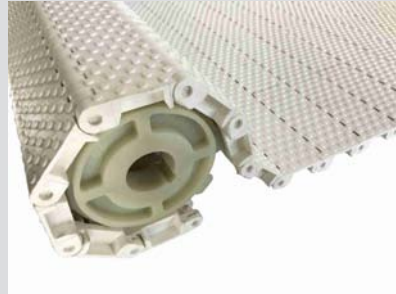
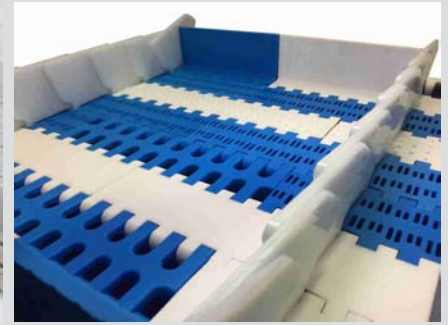
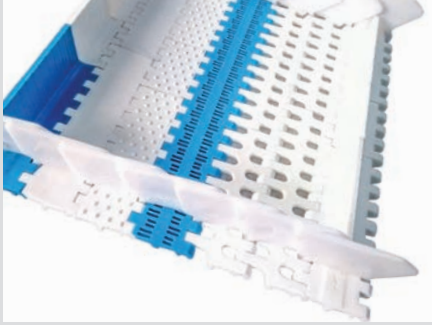
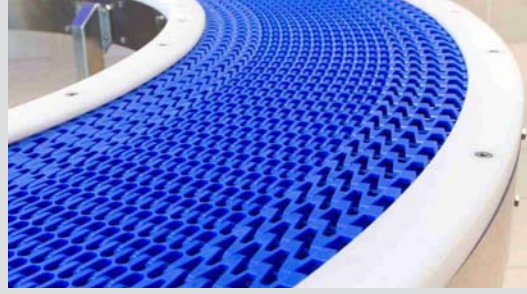



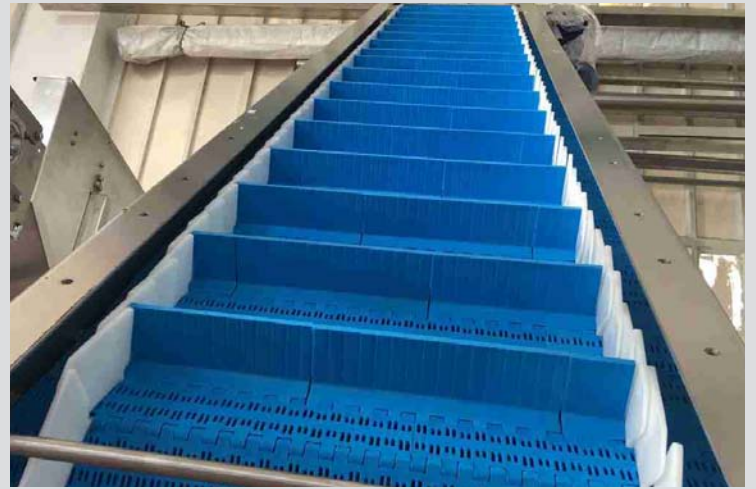
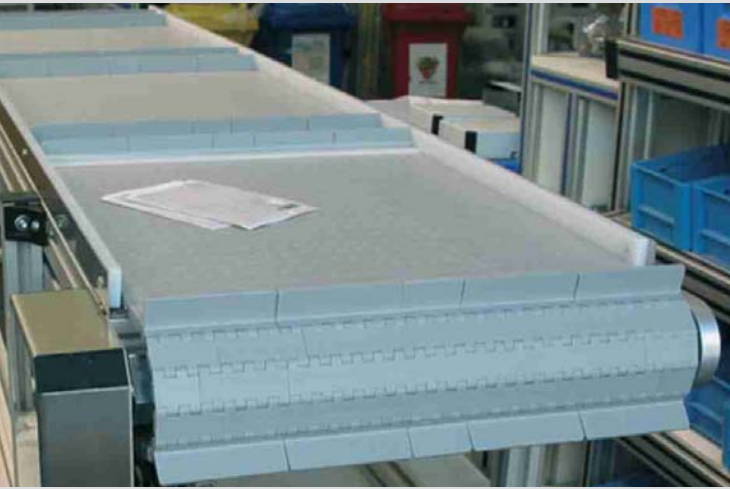
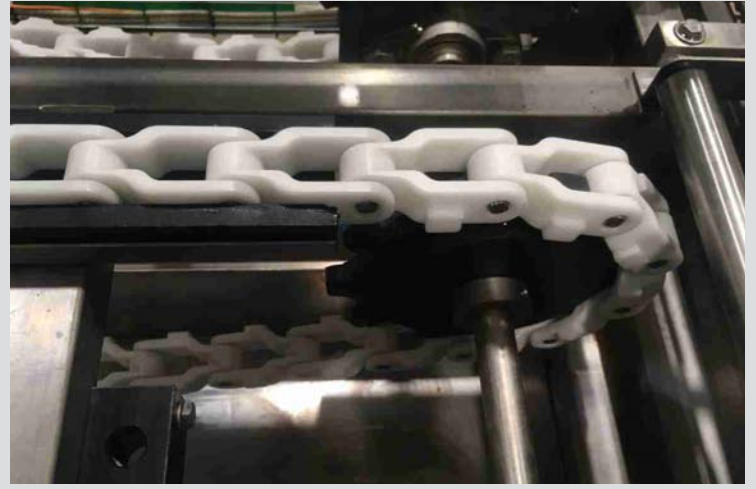
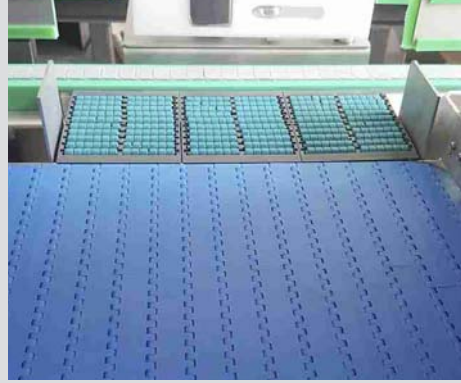



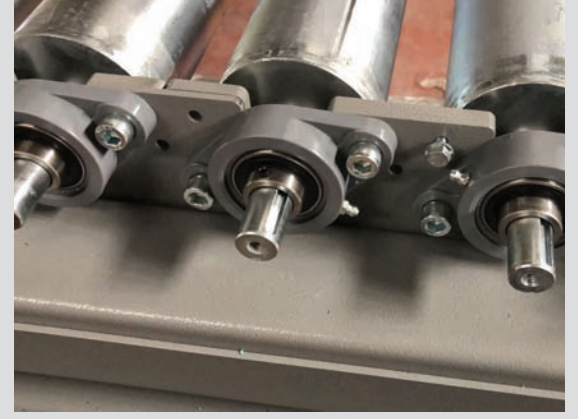



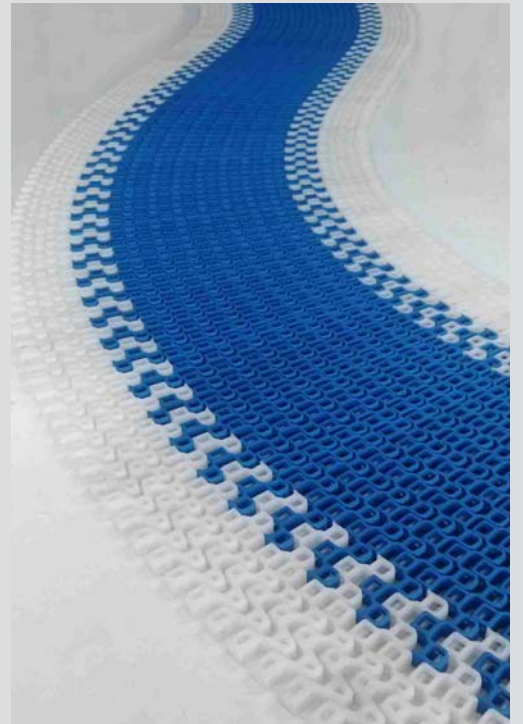
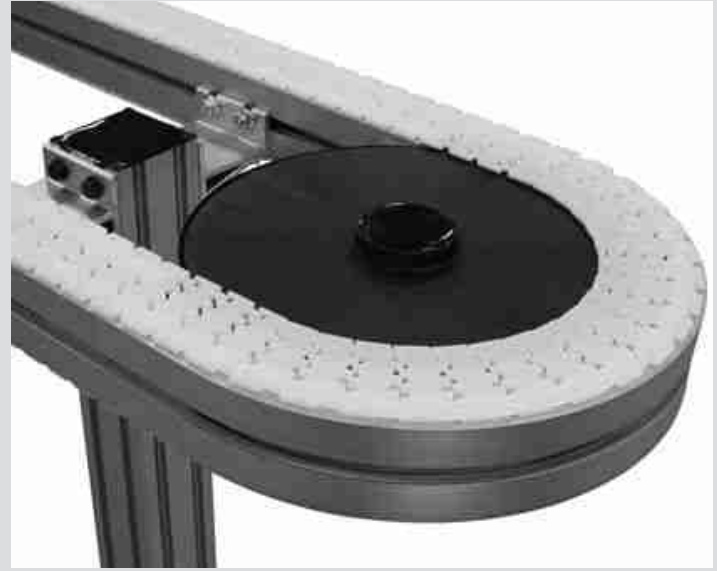
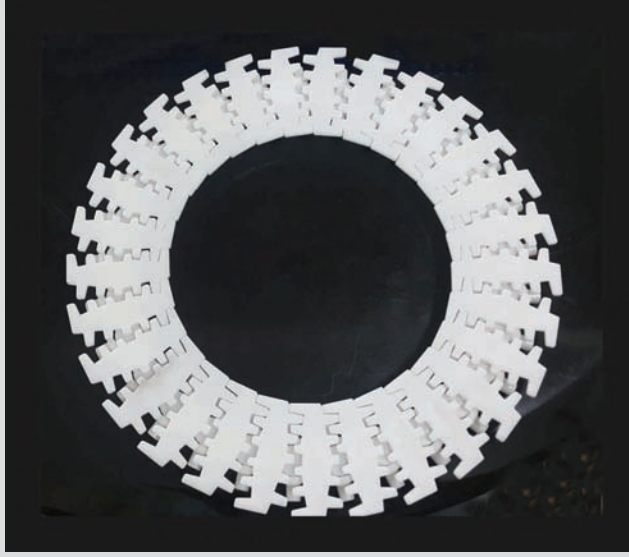



950-951 YILDIZ SERİSİ HASIR DÜZ TAŞIYICI BANT/STAR SERIE MODULAR CONVEYOR BELTS



Yeni  
New



50.8 mm

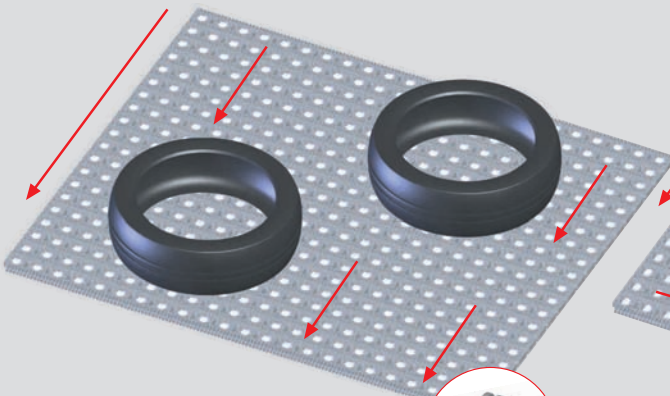
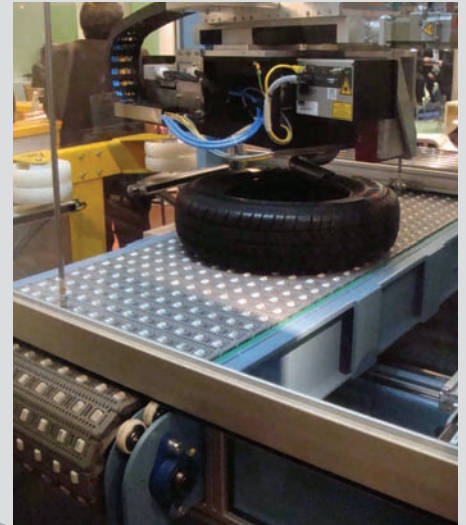
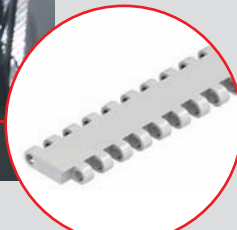
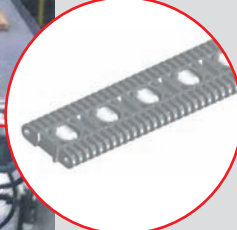
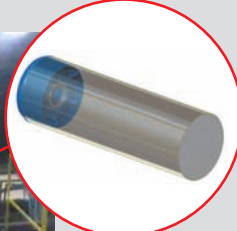
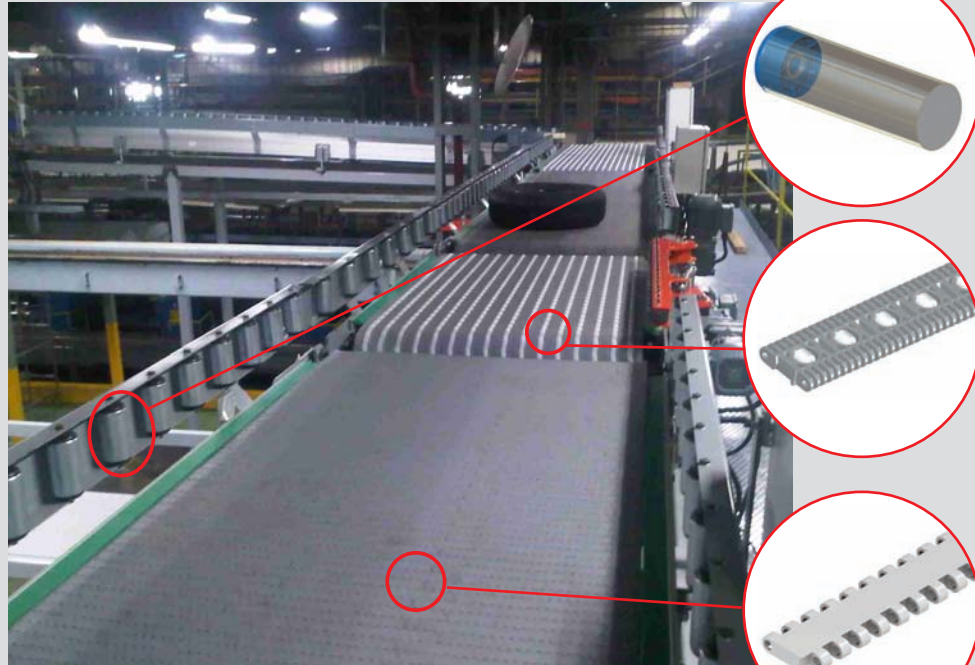
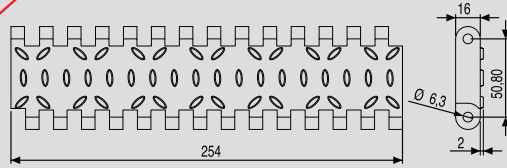

956 BİRİKTİRME  
MAKARALI HASIR BANTI  
ACCUMULATION ROLLER BELTS

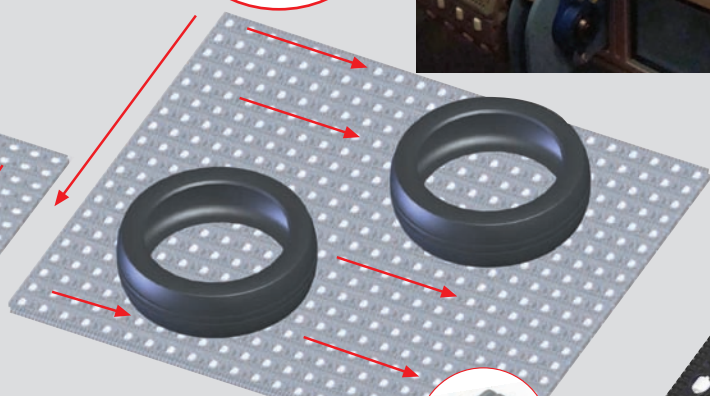
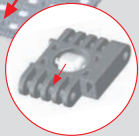

957 AKTARMA  
MARAKALI HASIR BANT  
TRANSFER ROLLER BELTS

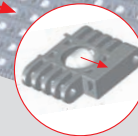



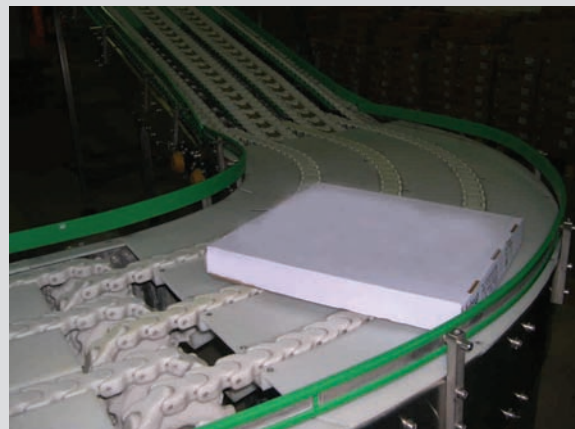



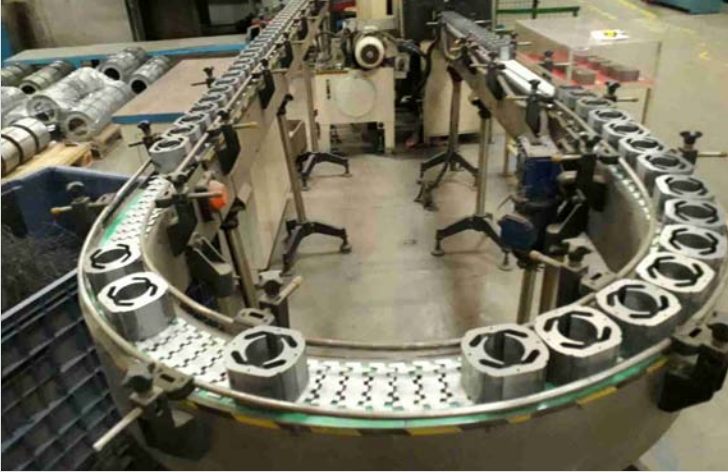



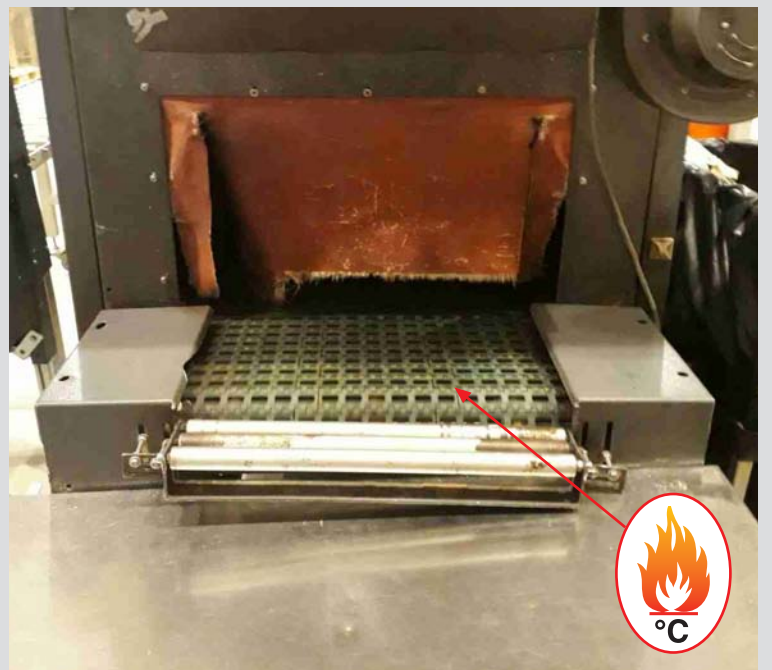
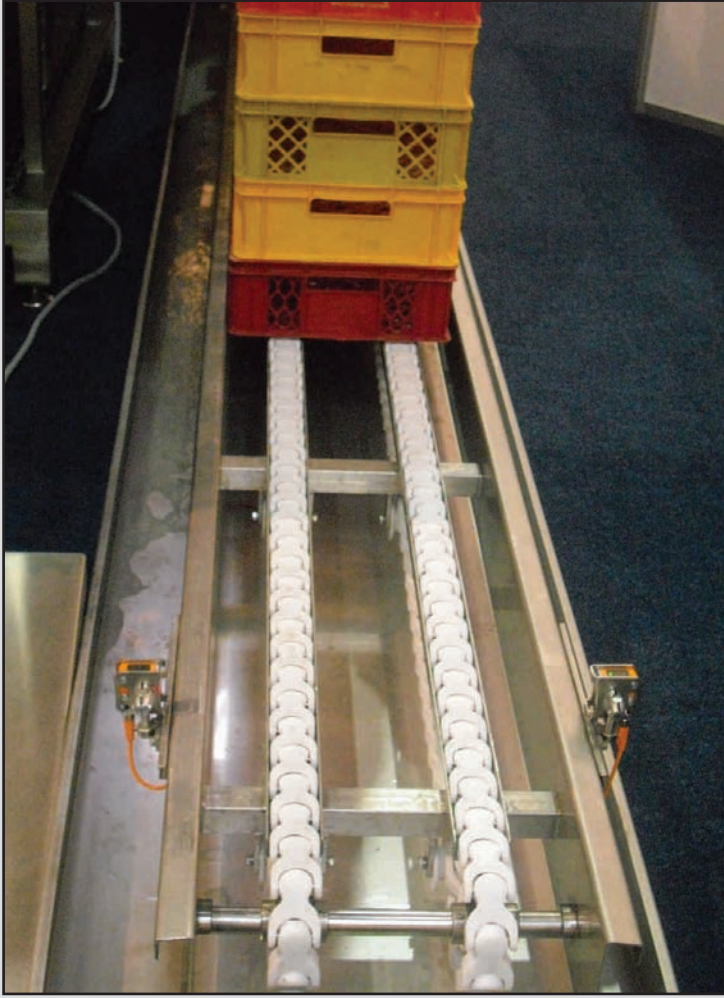



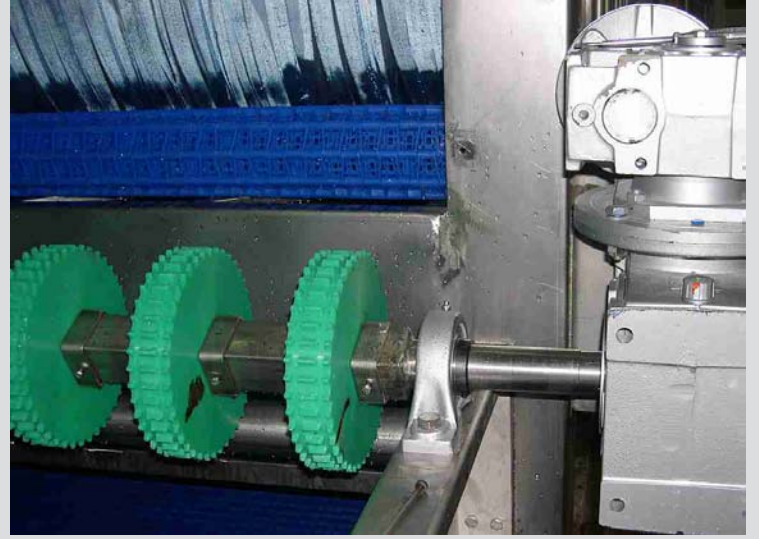
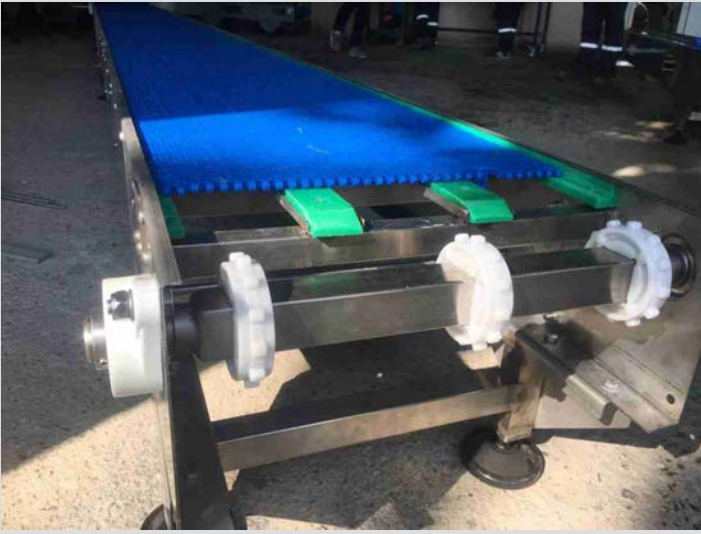
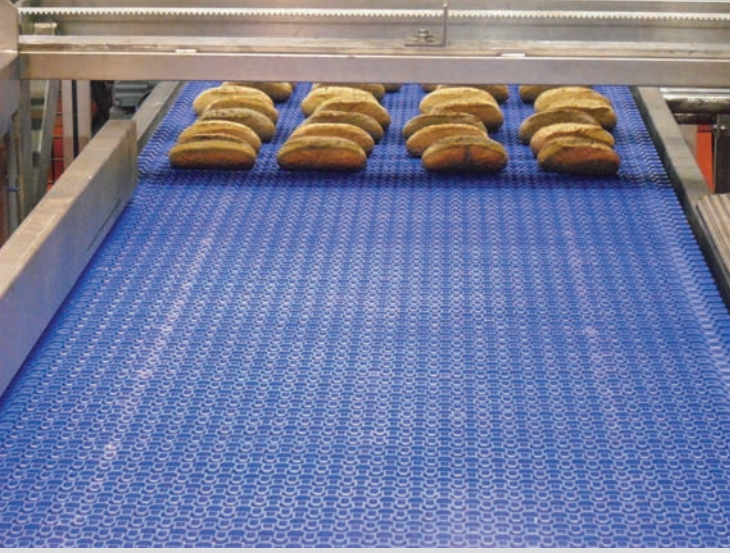



206 OÖZ



Z Profil Alpolen  
Guides for Bottling and Packaging

206 LMY



Düz Lama Profil Alpolen  
Flat Guides

206 OGZ

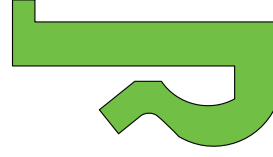

Geçmeli Z Profil Alpolen  
Guides for Bottling and Packaging

206 GLA

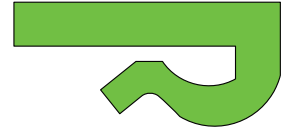

Geçmeli Profil Alpolen  
Guides for Bottling and Packaging

206 UO T

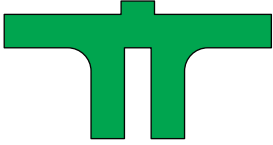

Tca Profil Alpolen  
Guides for Bottling and Packaging

206 OOL



L Profil Alpolen  
Guides for Bottling and Packaging

206 OTL



L/600 Profil Alpolen  
Guides for Bottling and Packaging

206 OOT



T Profil Alpolen  
Guides for Bottling and Packaging

207 DON

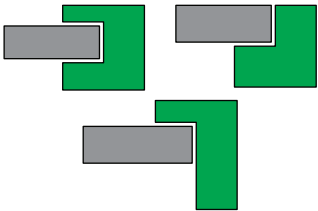

Alpolen 1000 Sürtünme Profilleri  
Guides for Bottling and Packaging

206 DOT



Tcal Profil Alpolen 1000  
Guides for Bottling and Packaging

207 HC



Alpolen 1000 Çelik Profilli HCC Kızakları  
Guides for Bottling and Packaging

207 CC



Alpolen 1000 Çelik C Sürtünme Profilleri  
Guides for Bottling and Packaging

207 OKT



Kulaklı T Profil Alpolen  
Guides for Bottling and Packaging

206 YD3



C Profil Alpolen  
Guides for Bottling and Packaging

206 YU1

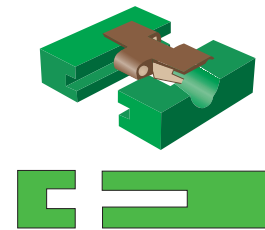

C Profil Alpolen  
Guides for Bottling and Packaging

206 BSA

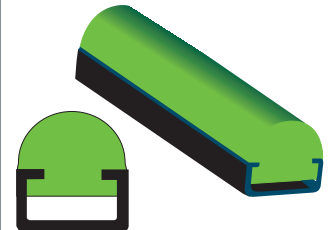

Yuvarlak Balık Sırtı Profil Alpolen  
Guides for Bottling and Packaging



**206 OOC**

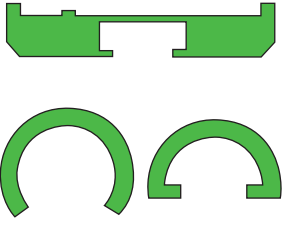

U/650 Profil Alpolen  
Guides for Bottling and Packaging

**207 OT...**

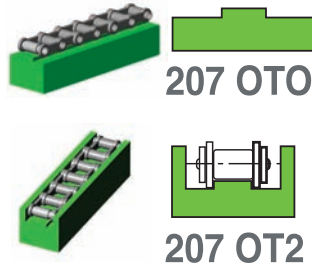

Alpolen T Model Zincir Kızakları  
Roller Chain Guides

**207 TH2**

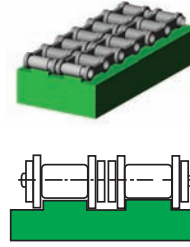

Alpolen 1000 2t Zincir Kızakları  
Roller Chain Guides

**207 TA4**

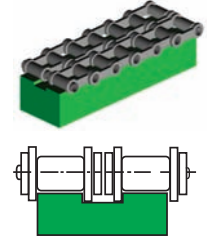

2T Ağır Tip Zincir Kızakları  
Roller Chain Guides

**207 OTT**

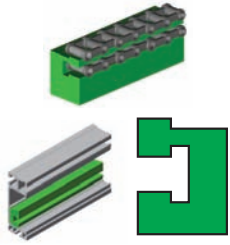

TT Zincir Kızakları  
Roller Chain Guides "TT"

**207 B33**

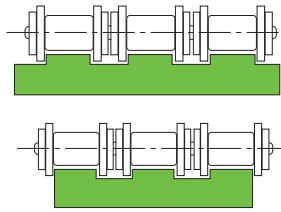

Alpolen 1000  
3 Sıralı Zincir Kızakları  
Roller Chain Guides "triple"

**207 TCG**

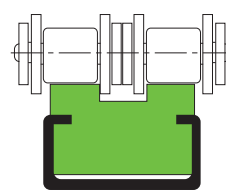

Alpolen 1000 TCG  
2T Ağır Tip Zincir Kızakları  
Roller Chain Guides "TCG"

**207 UCC**

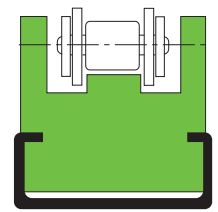

Alpolen 1000 UCC  
Zincir Kızakları  
Roller Chain Guides "UCC"

**207 UCD**

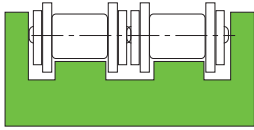

Alpolen 1000 UCD  
Zincir Kızakları  
Roller Chain Guides "UCD"

**207 1TT**

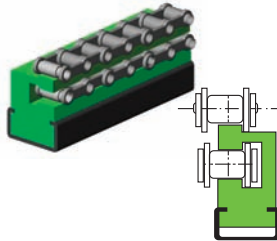

Alpolen 1 TT Model  
Tipi Zincir Kızakları  
Roller Chain Guides

**206 CCZ**

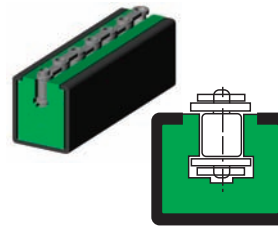

Alpolen CCZ Model Çelik  
Profilli Zincir Kızakları  
Roller Chain Guides

**207 BL**

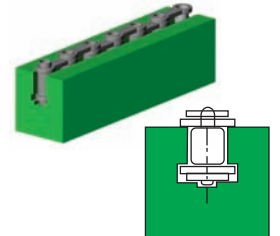

Alpolen 1000 BL  
Model Zincir Kızakları  
Roller Chain Guides

**207 CUO**

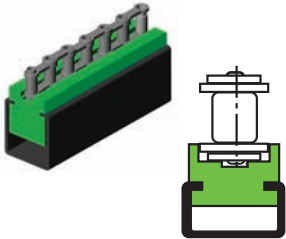

Alpolen 1000 U  
Model Zincir Kızakları  
Roller Chain Guides

**207 OU0**

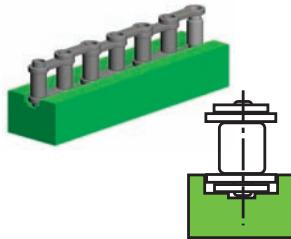

Alpolen 1000 U Zincir Kızakları  
Roller Chain Guides

**207 TU0**

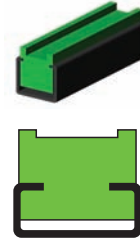

Alpolen 1000 U Düz Bantlar  
için Çelik Profilli Zincir Kızakları  
Straight Chain Guides

**207 H15**

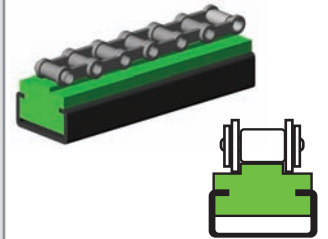

Alpolen 1000 T Model  
Çelik Profilli Zincir Kızakları  
Roller Chain Guides

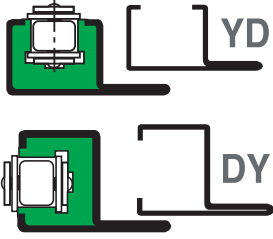

**207 YD-DY**

Alpolen 1000 Zincir Kızakları  
Chain Guides

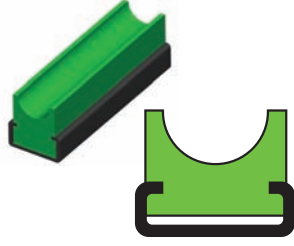
**207 CCO**

Alpolen 1000 Çelik  
Profilli Kayış Kılavuzları  
Cable and Belt Guides

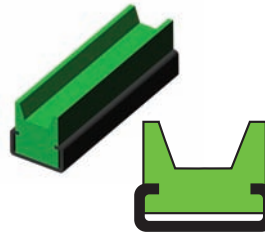
**215 VCO**

Alpolen 1000 Çelik  
Profilli V Kayış Kılavuzları  
Curves Track for 880 TAB-881 TAB Chains

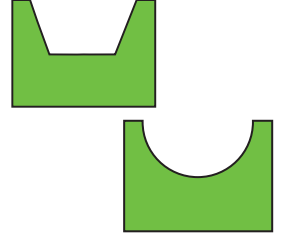
**207 CTV**

Alpolen 1000 (V) Kayış Kızakları  
Link Chain Guides

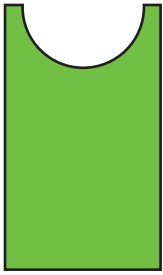
**207 CTO**

Alpolen 1000 Özel Kayış Kızakları  
Belt Guides

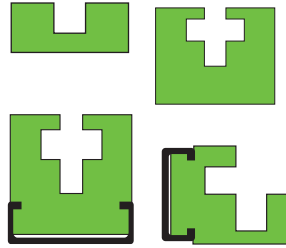
**207 GH1**

Alpolen 1000 Sıralı Zincir Kızakları  
Belt Guides

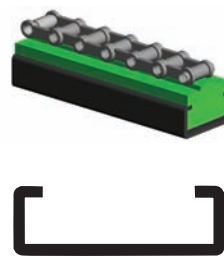
**206 C02**

Çelik Profiller  
Steel Profiles

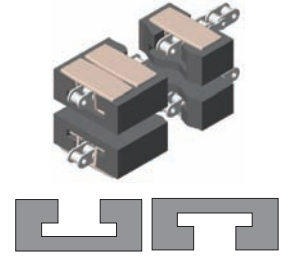
**202 863**

Doğrusal Yataklar 863 Serisi  
Straight Track (for 863 series)

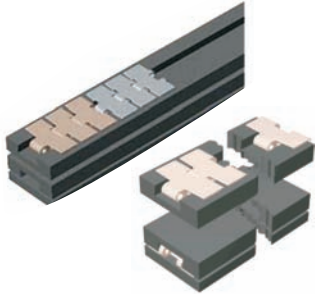
**202 880**

Alpolen 1000 Doğrusal Yatakları  
Straight Track (for 880-881 series)

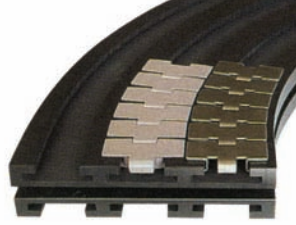
**215 500**

Alpolen 1000, 90° (880 Tab  
881 Tab Dönüşlü Bantlar İçin)  
Curves Track for 880 TAB-881 TAB chains

**205 500**

Alpolen 1000, 90° (880 Açılı  
Kulaklı Bantlar İçin) Dönüş Yatakları  
Curves Track (for 880 chains)

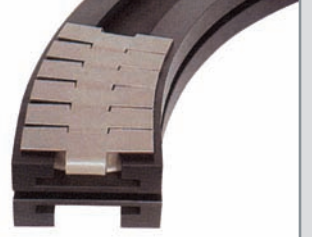
**215 610**

Alpolen 1000, 90° Dönüş Yatakları  
(882 Tab Dönüşlü Ağır Tip Bantlar İçin)  
Curves Track for 882 TAB chains/heavy duty)

**225 500**

Omurgalı (Kardenik)  
Bant Dönüş Takımı  
Curves Track for Cardanic Chains

**220 KSK**

Kasa Tasıma Bant Kızakları  
Guides for Crate Chains

**204 112**

Yarasa Bant Dönüş Ünitesi  
Curves Track for Bat Chains

**221 873**

Alpolen 1000, 90° Dönüş  
Yatakları (1873 Bantlar İçin)  
Curves Track (for 1873 series)



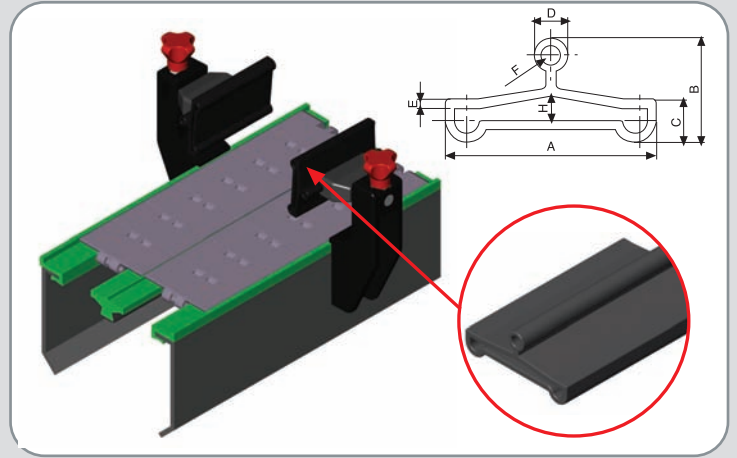
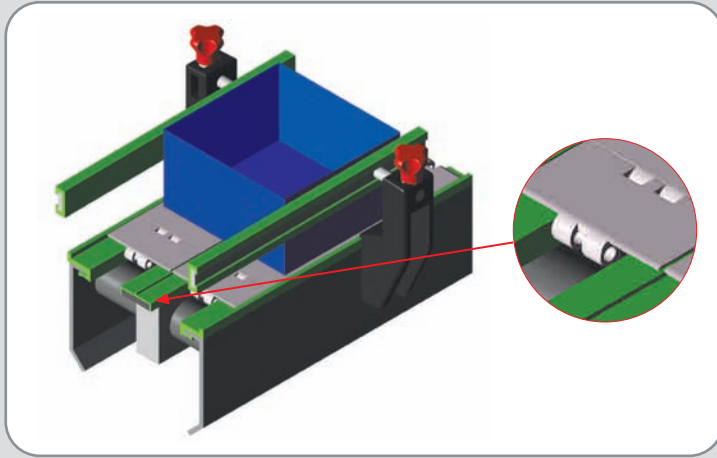
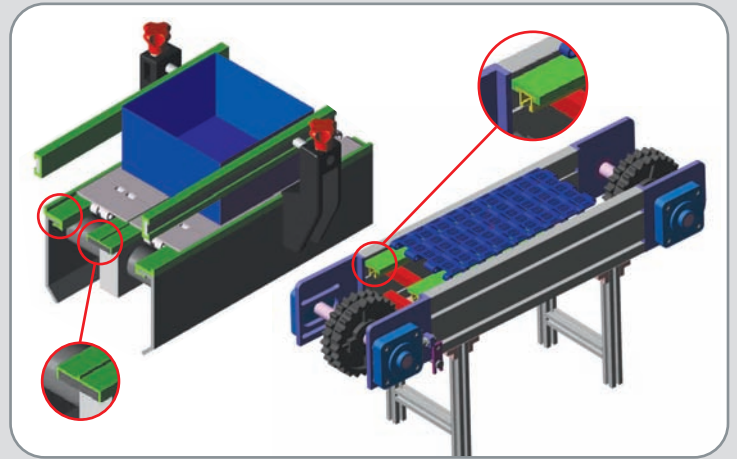
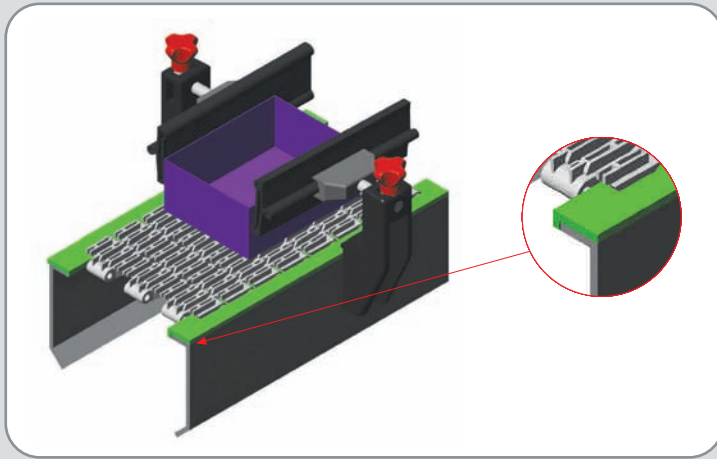
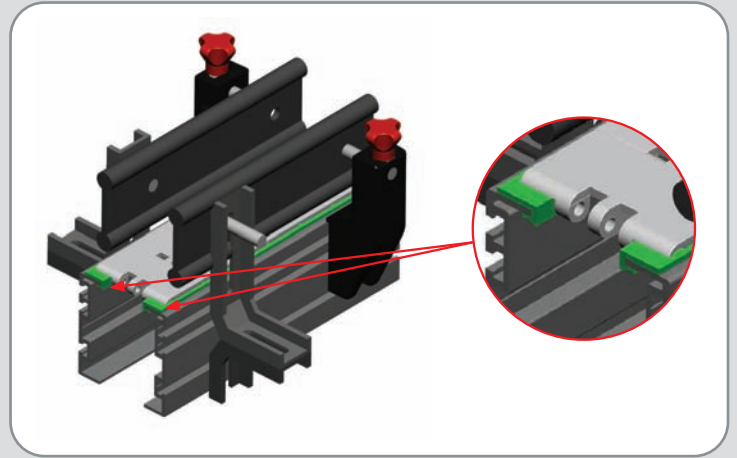
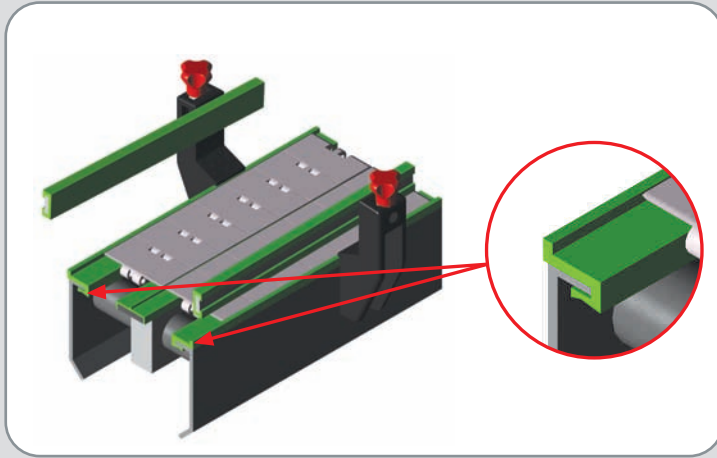
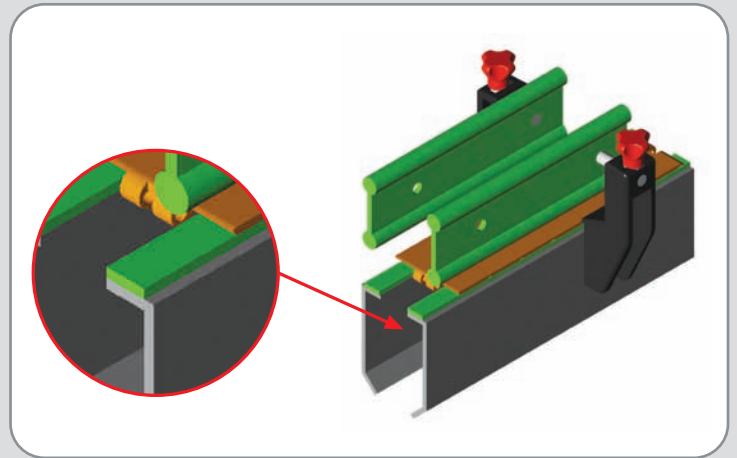
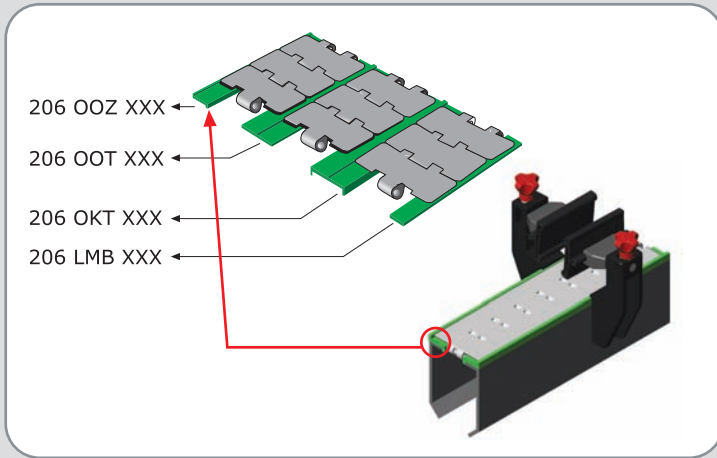



**ÖZEL PROFİL UYGULAMALARI/SPECIAL PROFILES APPLICATIONS**

**M** ALPOLEN® UHMW 1000

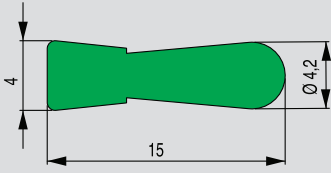

**206 RGL 232**

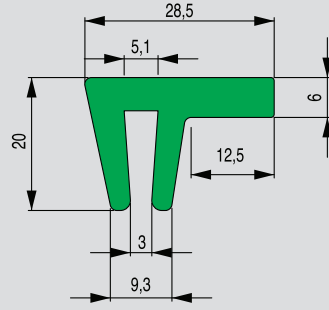

**206 GZU 221**

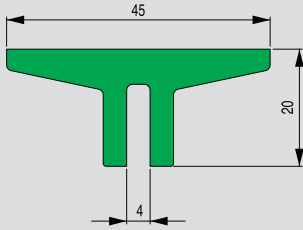
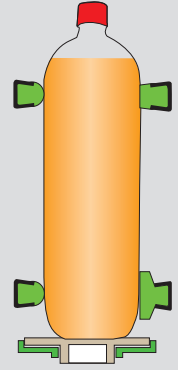
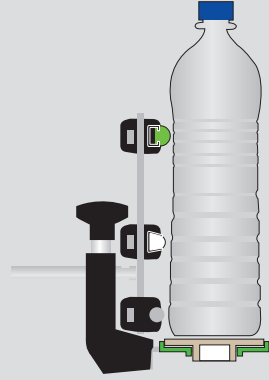

**206 RGU 088**

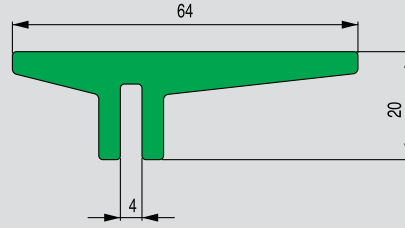

**206 RGD 089**

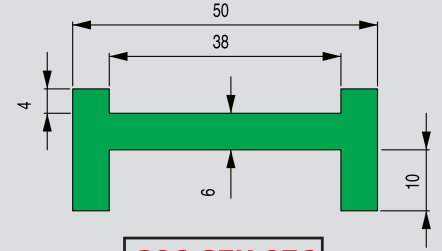

**206 GZU 076**

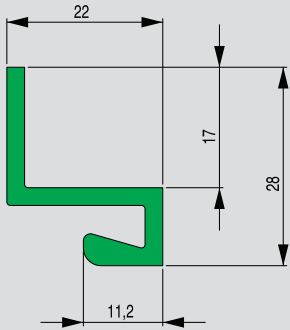

**206 OGL 108**

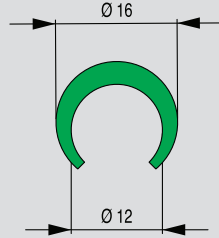

**206 RGU 415**

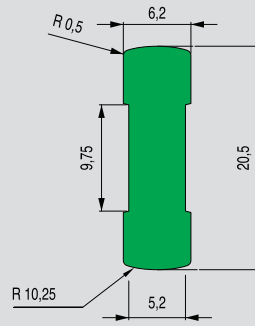

**216 100 104**

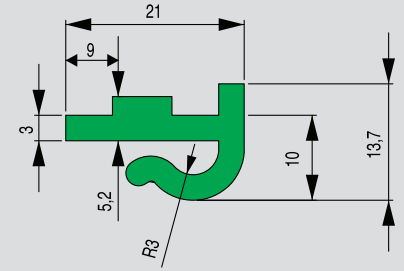

**206 GLA 266**

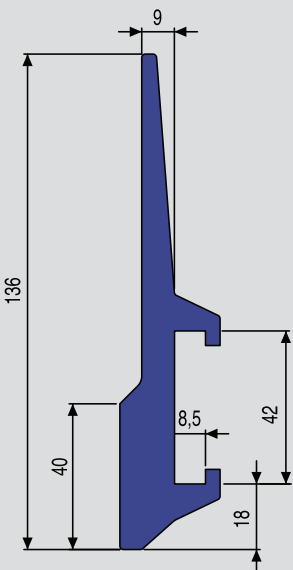

**206 RGC 330**

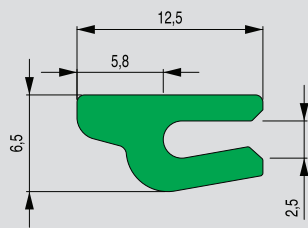

**206 RGC 352**

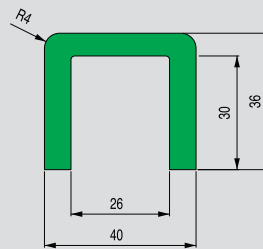

**206 GZU 026**

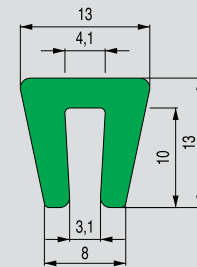

**206 RGU 219**

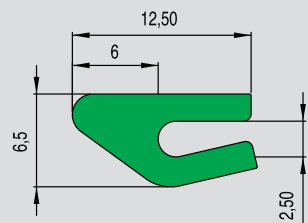

**206 RGB 351**

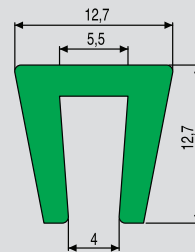

**206 RGU 413**

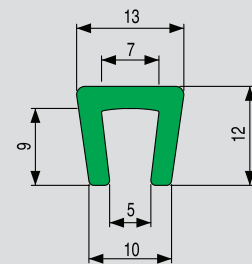

**206 RGU 023**





# B SÜRTÜRME PROFİLLERİ ve ZİNCİR KIZAKLARI FRICTION GUIDES & ROLLER CHAIN GUIDES

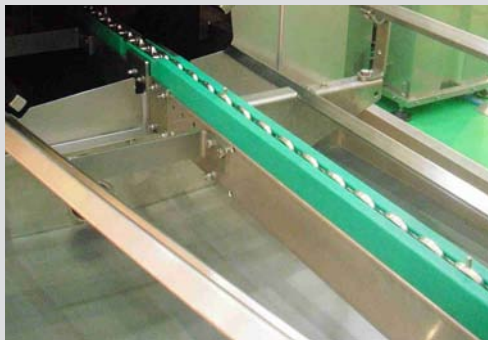
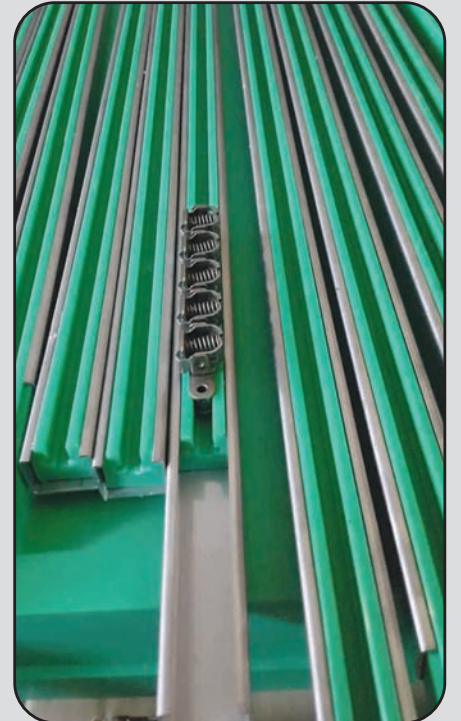
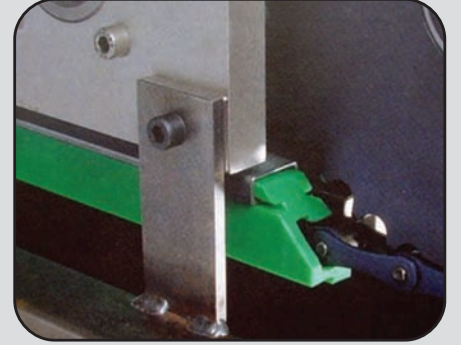
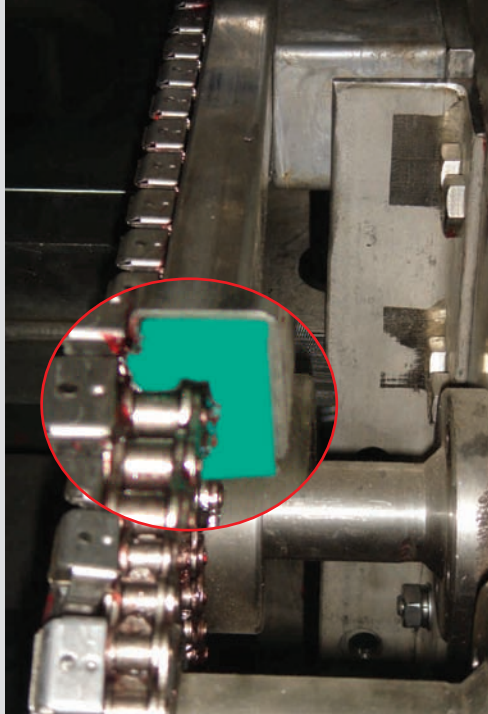
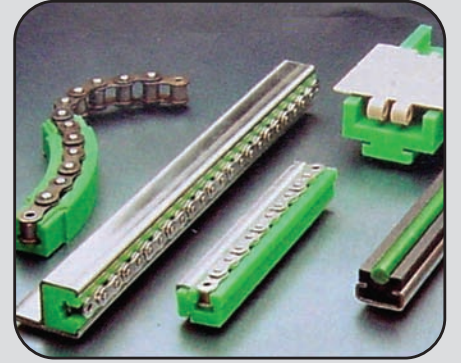
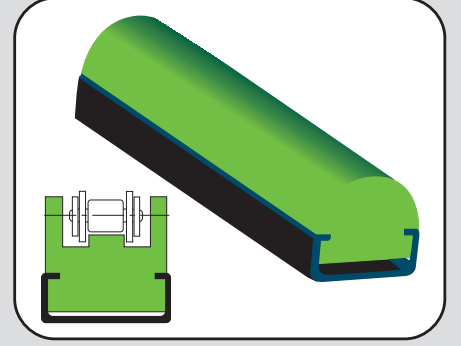
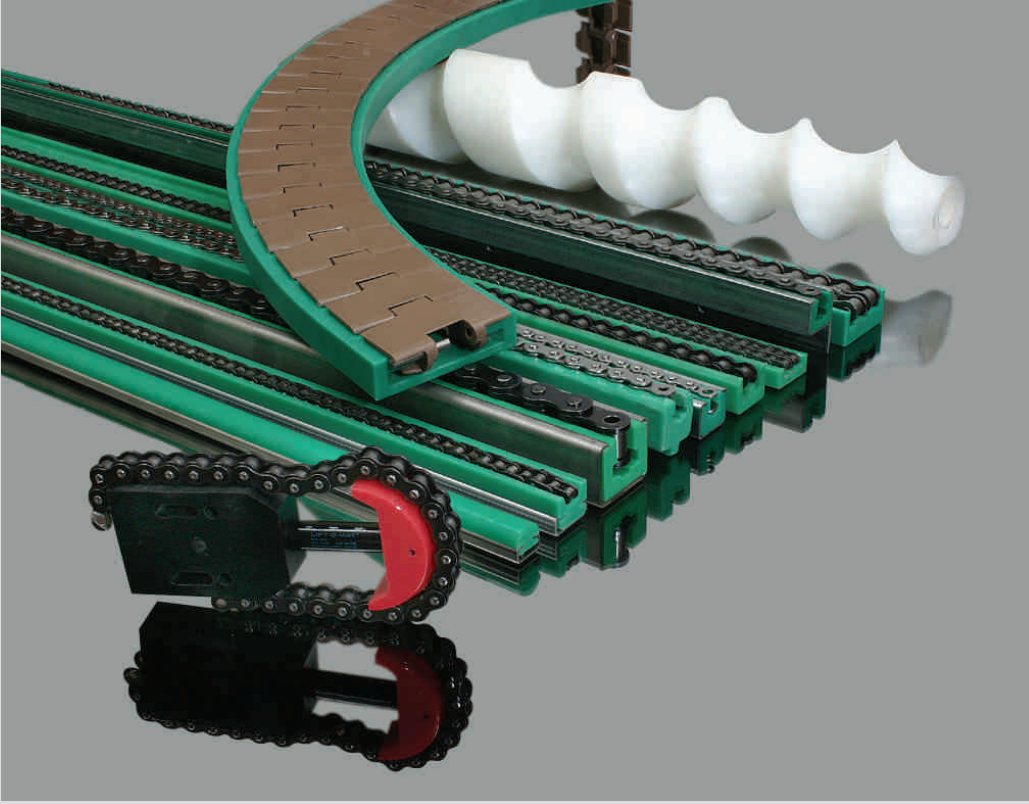



400



Sabit Plastik Pabuç (Metal Saplama)  
Plastic Fixed Feet

515 - 510



Düz Taban Plastik Pabuç  
(Metal Çinko Kaplama ve Paslanmaz)  
Articulated Feet

620 - 621



Döküm Tabanlı ve  
Milli Sabit Pabuç  
Articulated Feet

502 - 530



Çinko Kaplamalı ve Paslanmaz  
Ağır Tip Sabit Pabuçlar  
Hard Type Articulated Feet (with snap ring)

610 -611



Döküm Tabanlı ve Mafsallı Pabuç  
Spindle Articulated Feet

560



Çelik Paslanmaz Tabanlı  
ve Milli Mafsallı Pabuç  
Stainless Steel Base- Spindle Articulated Feet

605 - 606



Paslanmaz ve Metal Tabanlı  
Sabitlenebilir Pabuç  
Spindle Articulated Feet

521



Paslanmaz Sıvama Çelik  
Tabanlı ve Milli Mafsallı Pabuç  
Stainless Steel Base - Spindle (with rubber ring) Feet

520



Metal Sıvama Çelik  
Tabanlı ve Milli Mafsallı Pabuç  
Zinc Plated Steel Base Spindle (with rubber ring) Fix Feet

590



Paslanmaz Tabanlı  
Sabit Milli Pabuç  
Stainless Steel Base - Spindle (with snap ring) Fix Feet

580



Çinko Kaplamalı  
Sabit Tabanlı Pabuç  
Zinc Plated Steel Base - Spindle (with snap ring) Fix Feet

507



Çinko Kaplamalı Metal Tabanlı  
ve Milli Mafsallı Pabuç  
Zinc Plated Steel Base - Spindle (with snap ring) Fix Feet

500



Plastik Pabuç Tabanı  
500 Plastic articulated base

510



Plastik Taban  
510 Plastic articulated base



507-560



Mafsallı Metal ve Paslanmaz Taban  
507-560 Steel Base

230



Kare Profil Klavuzları  
Threaded Tube Ends (for square profile)

235



Yuvarlak Profil Klavuzları  
Threaded Tube Ends

220 211 110



Plastik İkili Ayak Açılı Boru ve Profil Bağlantılı  
Bipop (Angled)

220 211 120



Plastik İkili Ayak Açısız Boru Profil Bağlantılı  
Bipop

220 211 130



Plastik Üçlü Ayak

240 021 200



Yan Bağlantı Takozu  
Side Mounting Top Brackets

240 021 180



Gövde Bağlantı Takozu  
Support Heads

240 021 170



Ara Bağlantı Takozu  
Connecting Joint





**ALHAN**'ın  
ayak gücü





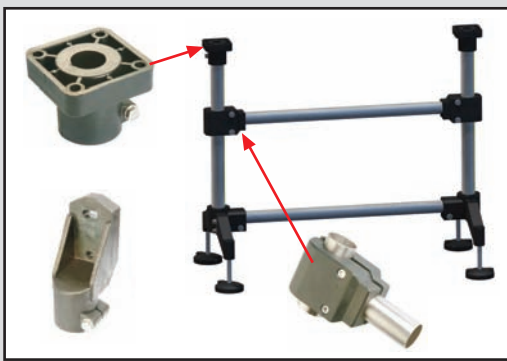

765 020 020



20x20 Alüminyum Sigma Profil  
20X20 Silver Anodized Aluminium Profile

765 025 025

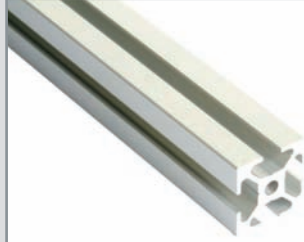

25x25 Alüminyum Sigma Profil  
25X25 Silver Anodized Aluminium Profile

765 030 030

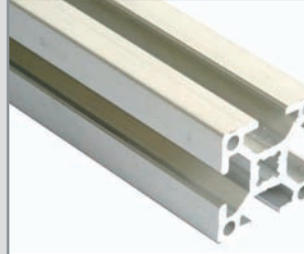

30x30 Alüminyum Sigma Profil  
30X30 Silver Anodized Aluminium Profile

765 040 040

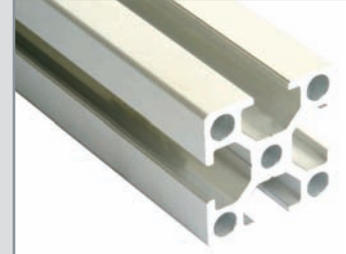

40x40 Alüminyum Sigma Profil  
40X40 Silver Anodized Aluminium Profile

765 025 150



25x150 Konveyör Yan Şase  
Alüminyum Sigma Profil  
25X150 Silver Anodized Aluminium Profile

765 085 075

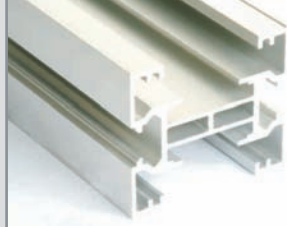

85x75 Alüminyum Sigma Profil  
Düz Kulak Yarasa Bant için  
85X75 Silver Anodized Aluminium Profile

766 085 075



85x75 Alüminyum Sigma Profil  
Silindir Kulak Yarasa Bant için  
85X75 Silver Anodized Aluminium Profile

765 045 045

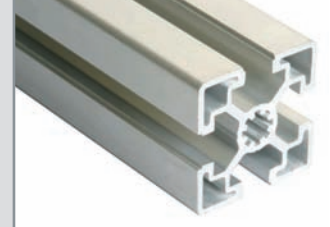

45x45 Alüminyum Sigma Profil  
45X45 Silver Anodized Aluminium Profile

765 050 050

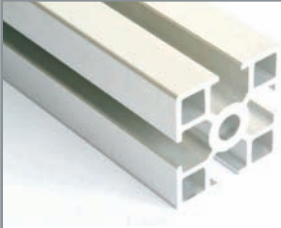

50x50 Alüminyum Sigma Profil  
50X50 Silver Anodized Aluminium Profile

765 023 129



23x129 Konveyör Yan Şase  
Alüminyum Sigma Profil  
23x129 Structural Silver Anodized Aluminium Profile

765 025 105



25x105 Konveyör Yan Şase  
Alüminyum Sigma Profil  
25X105 Structural Silver Anodized Aluminium Profile

765 025 115



25x115 Konveyör Yan Şase  
Alüminyum Sigma Profil  
25X115 Structural Silver Anodized Aluminium Profile

765 106 120



106X120 Alüminyum Sigma  
Profil Montaj Hattı için  
106X120 Assembly Line Aluminium Profile

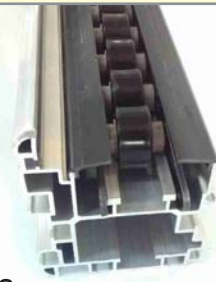

765 000 002

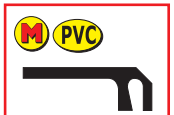

766 016 033

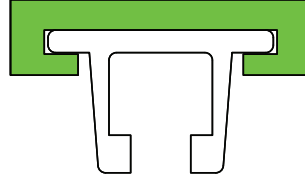
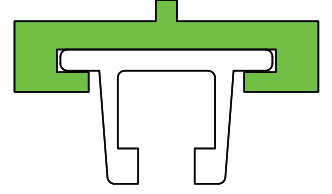
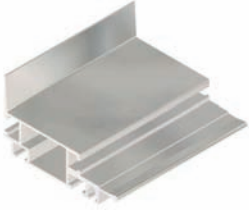
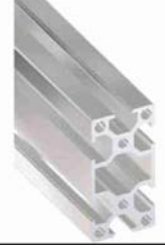

**766 011****Baklava Dilimli Kanal Somunu**  
Nut For Sigma Profile**206 APC 040****40 mm C Profil İçin Alüminyum Profil**  
Silver Anodized Aluminium Profile For Guides**206 AGC 040****40 mm C Profil Alpolen® + Alüminyum Profil**  
Alpolen® 1000**265 BSC 040****T Alpolen® + Alüminyum Profil**  
Alpolen® 1000**765 050 088****50x88 Konveyör Yan Şase Alüminyum Sigma Profil**  
50X88 Structural Silver Anodized Aluminium Profile**765 025 117****50x118 Konveyör Yan Şase Alüminyum Sigma Profil**  
50X118 Structural Silver Anodized Aluminium Profile**765 045 165****45x165 Alüminyum Sigma Profil**  
45X165 Structural Silver Anodized Aluminium Profile**765 040 080****40x80 Köşe Bağlantı Alüminyum Sigma Profil**  
40X80 Silver Anodized Aluminium Profile**765 045 090****45x90 Alüminyum Sigma Profil**  
45X90 Silver Anodized Aluminium Profile**766 013 070****Bayrak Köşe Bağlantı (75x75)**  
Corner Connection (75X75)**766 013 111****Bayrak Köşe Bağlantı (110x110)**  
Corner Connection (110X110)**766 013 145****110x110 Bayrak T Bağlantı Açısı Ayarlı**  
"T" Flat Connection (110X110)**766 013 112****110x110 Bayrak T Bağlantı**  
"T" Flat Connection (Angled)**766 012 012****Köşe Bağlantı 90° (Üst-Alt)**  
Simple Side Attachment**766 011 011****Köşe Bağlantı 90° (Sağ-Sol)**  
Simple Front Attachment**766 011 001****Alüminyum Profil Çekirme Pimi**  
Aluminium Profile Draw-PIN

766 015

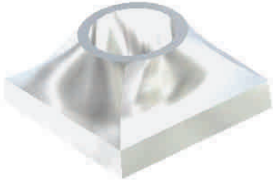

Kare Kanal Somunları  
Nut

766 010



Yaylı Somunlar  
Arc Nut

766 018 002



23x129 Alüminyum  
Germe Plakası Takımı  
(23X129) Aluminium Profile Stretcher Plate Set

766 018 001



23x129 Alüminyum  
Tahrik Plakası Takımı  
(23X129) Aluminium Profile Support for  
Axis and Bearing Plate Set

766 018 003



25x150 Alüminyum  
Germe Plakası Takımı  
(25X150) Aluminium Profile Support for  
Axis and Bearing Plate Set

766 018 004



25x150 Alüminyum Tahrik Plakası  
(25X150) Aluminium Profile Support for  
Axis and Bearing Plate Set

766 018 007



45x45 Alüminyum Profil  
Tahrik Plakası Takımı  
(45X45) Aluminium Profile Support for  
Axis and Bearing Plate (Right-Left)

766 018 008



45x45 Alüminyum Profil Avare  
Plakası Takımı (Sağ Ve Sol)  
(45X45) Aluminium Profile Support for  
Axis and Bearing Plate (Right-Left)

760 018 009

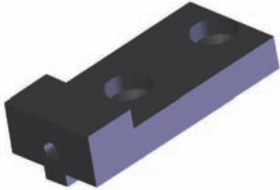

45x45 Alüminyum Profil Avare  
Gerdirme Aparatı Takımı  
(45X45) Aluminium Profile Support for  
Axis and Bearing Plate

766 019 009



45x90 Alüminyum Avare  
Plakası Takımı (Sağ Sol)  
(45x90) Aluminium Stretcher Plate (Right-Left)

766 019 010



45x90 Alüminyum Tahrik  
Plakası Takımı (Sağ Sol)  
(45X90) Aluminium Profile Support  
for Axis and Bearing Plate

766 019 011

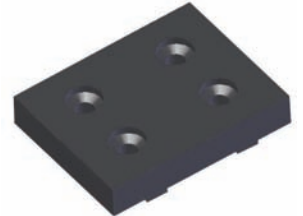

45x90 Alüminyum Profil Avare  
Gerdirme Aparatı Takımı  
(45X90) Aluminium Profile Support for Axis

766 016 001

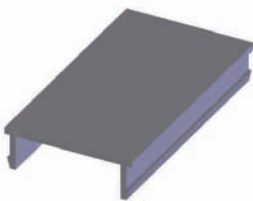

Alüminyum Profil Kanal Fitili (8)  
Aluminium Strip Profile (8)

766 016 002

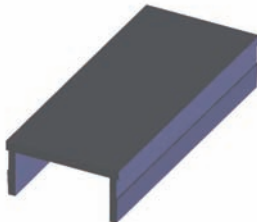

Alüminyum Profil Kanal Fitili (10)  
Aluminium Strip Profile (10)

766 016 003

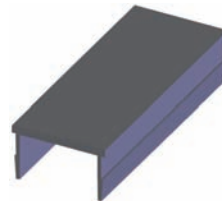

Alüminyum Profil Kanal Fitili (10)  
Aluminium Strip Profile (10)

766 311



Plastik Köşe Bağlantı 45x45  
Side Connection (Plastic)



766 014 020



20x20 Plastik Profil Kapağı  
20X20 Plastic Profile Cover

766 014 025



25x25 Plastik Profil Kapağı  
25X25 Plastic Profile Cover

766 014 590



45x90 Plastik Profil Kapağı  
45X90 Aluminium Profile Cover

766 RUT

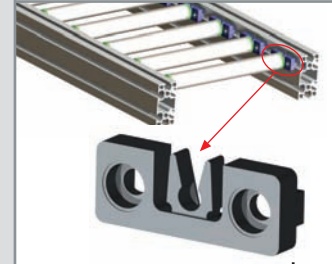

Rulolu Koverörler İçin  
Rulo Tutucu  
Roll Holder For Roller Conveyor

766 SBP



Sigma Profil Ayak  
İçin Plastik Bağlantı  
Side Support

766 011 003



Zamak Köşe Bağlantı 30x30  
30X30 Brackets

765 111

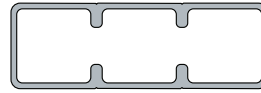

90x30 Alüminyum Sigma Profil  
90x30 Aluminium profile

765 222

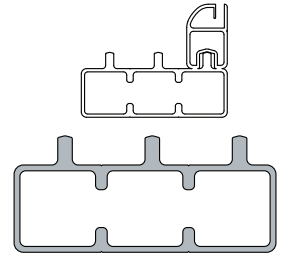

90x30 Alüminyum Sigma Profil  
90x30 Aluminium profile

765 333

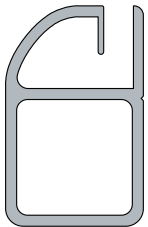

40x25 Alüminyum Sigma Profil  
40x25 Aluminium profile

765 444

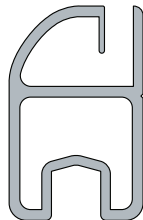

40x25 Alüminyum Sigma Profil  
40x25 Aluminium profile

765 555

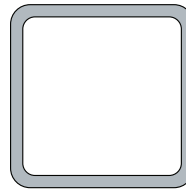

30x30 Alüminyum Sigma Profil  
30x30 Aluminium profile



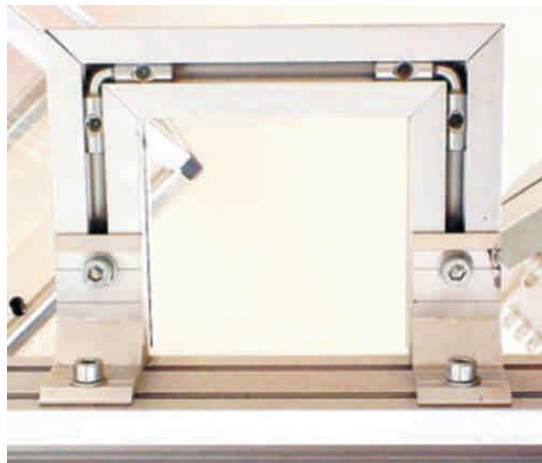
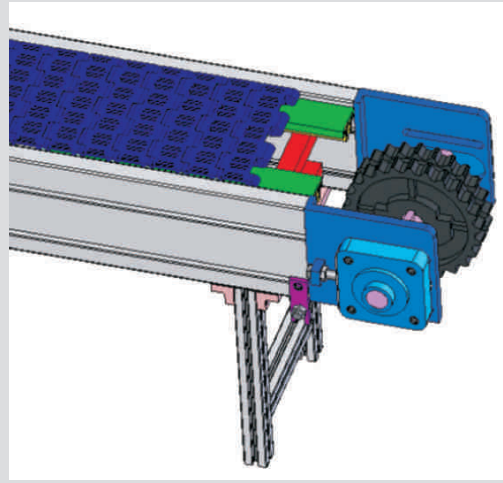
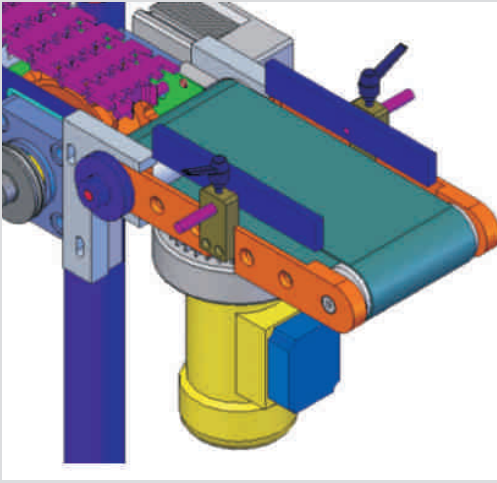
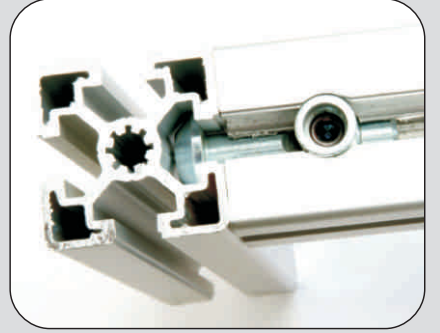
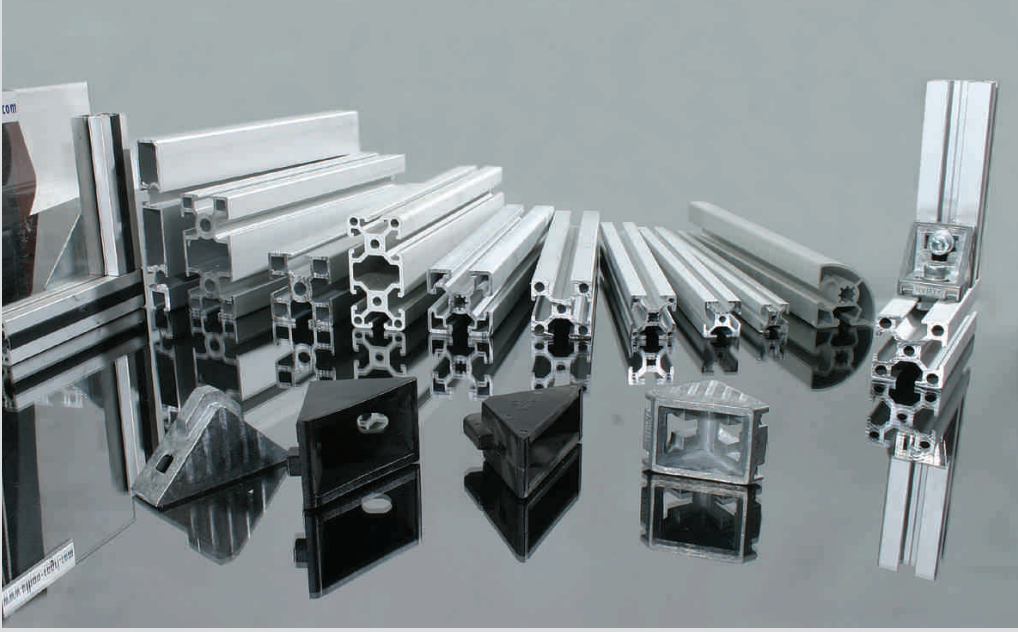



**210 IBB**



Dar Balık Sırtı Profil  
Tekli Mengene (Milli)  
Single Clamp with Rod

**210 DTY M...**



Dar Sırtlı Mengene (Milli)  
Single Clamp with Rod

**211 60P MLL**



60 mm Pvc Profil  
için Mengene (Milli)  
Single Clamp with Rod

**210 DTT M...**



Dar Tekli Mengene (Milli)  
Single Clamp with Rod

**210 010 161**



Konsol Mengene Takımı  
(İkili-Milli)  
Clamps for Round Profile Guides (with Pin)

**210 DTY A04**



Balık Sırtı Profil için  
Geniş Mengene (Milli)  
Single Clamp with Rod

**800 240**



Balık Sırtı Profil için  
Geniş Mengene (Milli)  
Single Clamp with Rod

**210 GTT**



Geniş Tutucu Tekli  
Mengenesi (Milli)  
Guide Rail Clamp with Rod

**210 DTT**



Dar Tekli Mengene (Milsiz)  
Single Clamp

**211 IBB 000**

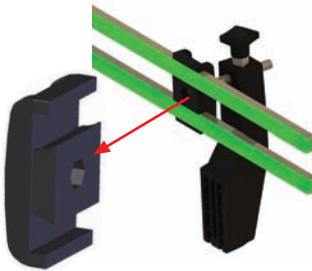

Balık Sırtı Profil İki Mengene  
Double Clamp with Rod

**211 60P**



60 mm PVC Kenar Dayama Profili  
Single Clamp

**210 IIB**



Balık Sırtı Profil Dar Tekli Mengene  
Single Clamp with Profile

**210 DTY**



Dar Sırtlı Tekli Mengene  
Single Clamp with Profile

**210 GTT**



Geniş Tutucu Tekli Çubuk Mengenesi  
Guide Rail Clamps

**800 210 134**



Balık Sırtı Profil Geniş  
Mengene Kapalı Tip  
Single Clamp

**800 210 133**



Balık Sırtı Profil Geniş  
Açık Tip Mengene  
Single Clamp

**FBL**



FBL Rulman Yatakları  
Omega Bearing Insert

**PPL**



PPL Rulman Yatakları (Köprü)  
Omega Bearing Insert

**TBL**



TBL Rulman Yatakları  
Omega Bearing Insert

**NFL**



NFL Rulman  
Yatakları (Badem)  
Omega Bearing Insert

**FPL**



FPL Rulman  
Yatakları (Kare)  
Omega Bearing Insert

**TPL**



TPL Rulman  
Yatakları (Gergi)  
Omega Bearing Insert

**HPL**



HPL Rulman Yatakları  
Omega Bearing Insert

**CFL**



CFL Rulman  
Yatakları (Badem)  
Omega Bearing Insert

**KFL**



KFL Rulman  
Yatakları (Badem)  
206 Bearing Unit

**UCF**



UCF Rulman  
Yatakları (Kare)  
Omega Bearing Insert

**KAP**



Rulman Yatak Kapağı  
Closed Cover

**214 151**



Fotosel Çapraz Tutucu Mengenesi  
Cross Block for guides

**214 152 010-012**



Fotosel Gövde  
Bağlama Mengenesi  
Photocell Cross Block

**214 1 530 010-012**



Fotosel Tutma Mengenesi  
Photocell Clamp

**214 IFM 000**

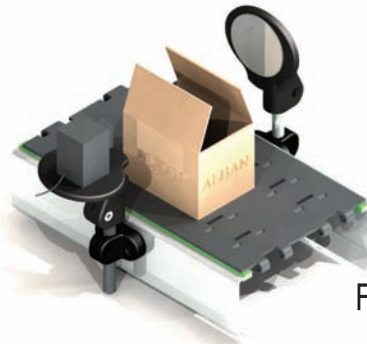

Fotosel Ayna Tutucu  
Photocell Reflectors



210 410 200



Konsol Gövdesi (Küçük Boy)  
Adjustable Brackets

210 010 200



Konsol Gövdesi (Orta Boy)  
Adjustable Brackets

210 010 201



Konsol Gövdesi (Büyük Boy)  
Adjustable Brackets

210 410 100



Orta Boy Konsol Tabanı  
Support Spacer

210 100 100

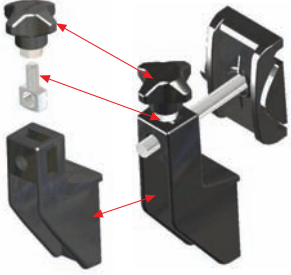

Konsol Tam Takım (Küçük Boy)  
Adjustable Brackets

210 100 200



Konsol Tam Takım (Orta Boy)  
Adjustable Brackets

210 100 300



Konsol Tam Takımı (Büyük Boy)  
Adjustable Brackets

215 000 101



Plastik Mentеше 49x65  
Hinges

215 000 104



Plastik Mentеше 49x49  
(Somunlu)  
Hinges

215 000 102



Plastik Mentеше 78x100  
78X100 Hinges

215 SZA



40X40, 50X50, 60X60  
Zamak Mentеше  
40X40, 50X50, 60X60 Hinges

215 000 103



Plastik Mentеше Vidalı 49x49  
49X49 Hinges

210 D10 024



Dişi Tutgaçlar  
Knobs

210 E10 025



Erkek Tutgaçlar  
Knobs

210 222 100



Yüksük  
Eyebolt for Knob

210 122 100



Plastik Yüksük  
Eyebolt for Knob

261 504 532



Avare Rulo Başlığı  
Idle rollers

271 434



Avare Rulo Başlığı  
Idle rollers

795 025 070



Rulmanlı Rulo Başlığı  
Bushing Rollers Heads

758 000 PAG



Su Fiskiyesi  
Nozzle

210 IDT 200



Dönürlü Konsol Gövde  
Adjustable Brackets

216 SKA 000



Sürgülü Kilit  
Spring Lock

767 000 004



Çerçeve Cam Tutucu  
Panel Clamp

753 050 030



50x30 Kablo Tasıma Kanalı  
Cable chains

216 100 001



Profil Tarağı  
Chain Return Components

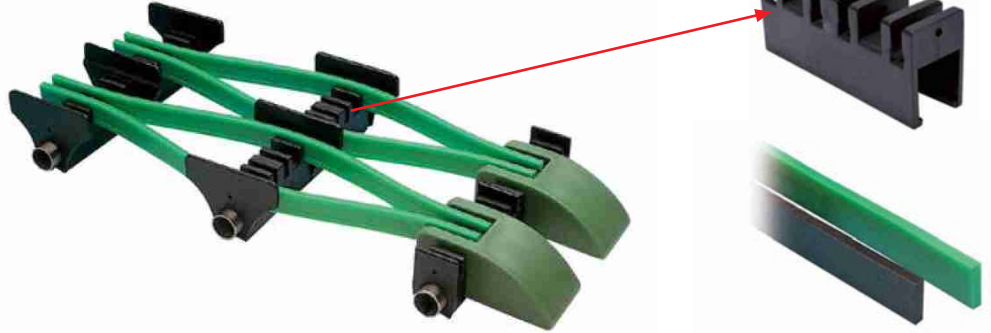

800 411 660



Boncuk Makara 4 Sıralı  
Roller Guide (Four roller design)

800 414 657



Boncuk Makara 3 Sıralı  
Roller guide (three roller desing)

800 411 654

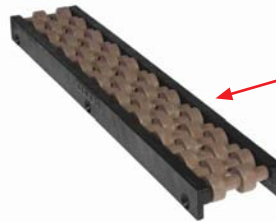

Boncuk Makara 2 Sıralı  
Roller guide (three roller desing)





241 200



Dönüslü Dişi Kol  
Adjustable hanle

241 100



Dönüslü Erkek Kol  
Adjustable hanle

689 000

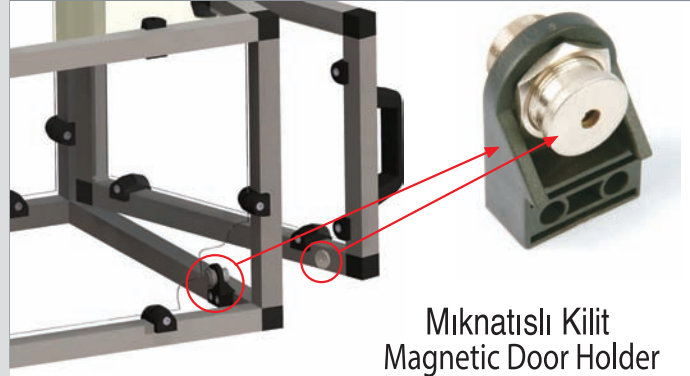

Mıknatıslı Kilit  
Magnetic Door Holder

764 EKS 001



Kapama Sistemleri  
Frame systems

764 CKS 001



Kapama Sistemleri  
Frame systems

764 BKS 001



Kapama Sistemleri  
Frame systems

764 AKS 001



Kapama Sistemleri  
Frame systems

764 FKS 001



Kapama Sistemleri  
Frame systems

764

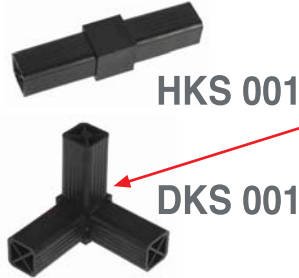

Kapama Sistemleri  
Frame systems

764 GKS 001



Kapama Sistemleri  
Frame systems

252 000



Bakalit Kapak Kolu  
Handles

252 710



Plastik Kapak Kolu  
Handles

252 620



Plastik Kapak Kolu  
Handles

215 UKK



Uzun Kapak Kolu  
Handles

KTR



Plastik Rulo Başlığı Ø16  
Bearings Ø16

KTR



Plastik Rulo Başlığı Ø30  
Bearings Ø30

KTR



Plastik Rulo Başlığı Ø20  
Bearings Ø20

KTR



Plastik Rulo Başlığı Ø40  
Bearings Ø40

KTR



Plastik Rulo Başlığı Ø50  
Bearings Ø50

MKR



Plastik Tekerlek  
Plastik Wheel

MTR



Metal Rulo Başlığı Ø20  
MTR Bearing Ø20

MTR



Metal Rulo Başlığı Ø30  
MTR Bearing Ø30

MTR



Metal Rulo Başlığı Ø40  
MTR Bearing Ø40

MTR



Metal Rulo Başlığı Ø50  
MTR Bearing Ø50

MTR



Metal Rulo Başlığı Ø60  
MTR Bearing Ø60

MTR



Metal Rulo Başlığı Ø60  
MTR Bearing Ø60

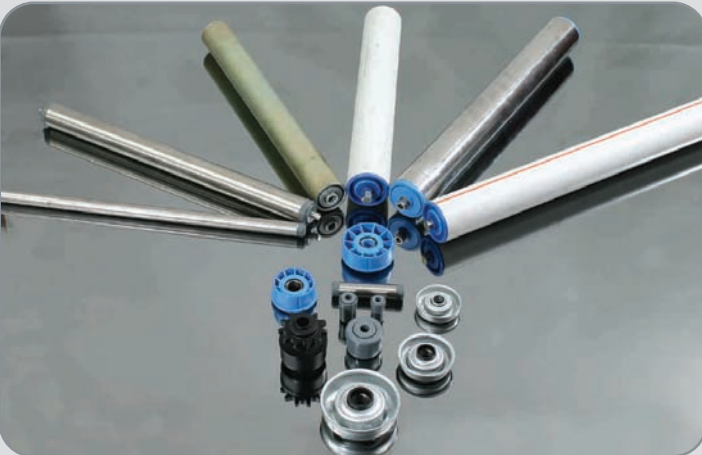



DSH



Volan Tutgaç  
Handwheels

VM



Volan Tutgaç  
Handwheels

VP



Volan Tutgaç  
Handwheels

VR



Volan Tutgaç  
Handwheels

215



Yaprak Mentеше  
Leaf Hinges

800 411

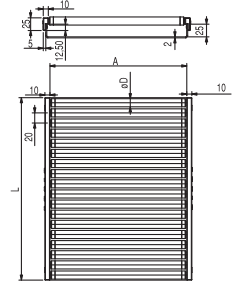

Ø16'lik Makara Rulolu Kılavuz  
Roller Guide

215 ICB



Dönüş Konsol Başlığı  
Heads Type

700 640

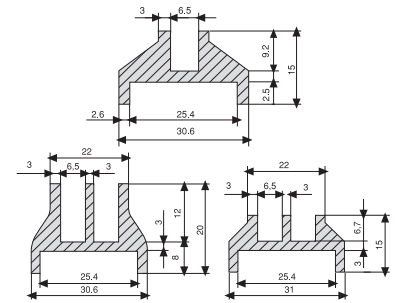

Açılır Çerçeve Profilleri  
Runner Profiles

700 640

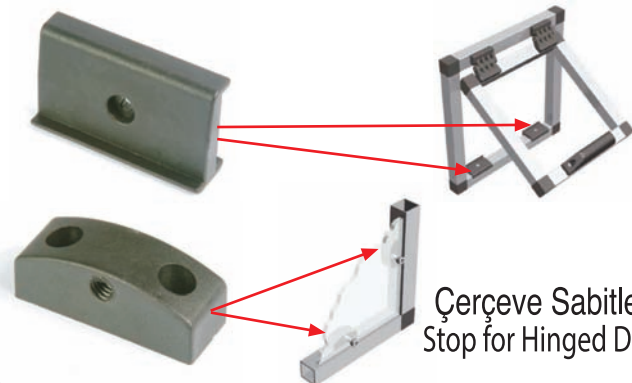

Çerçeve Sabitleyici  
Stop for Hinged Doors

Alhan Rulman Yatakları

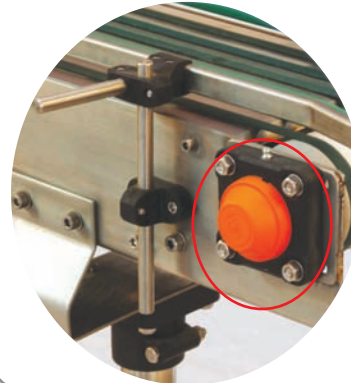

**GP40A**



Makaralı Ray  
Roller Guide

**GP40C**



Makaralı Ray  
Roller Guide

**GR40**



Makaralı Ray  
Roller Guide

**GR60**



Makaralı Ray  
Roller Guide

**GP60S**

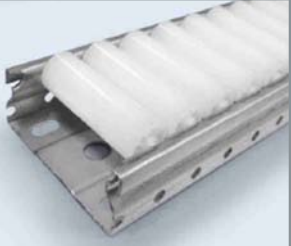

Makaralı Ray  
Roller Guide

**GP60B**



Makaralı Ray  
Roller Guide

**GP60A**

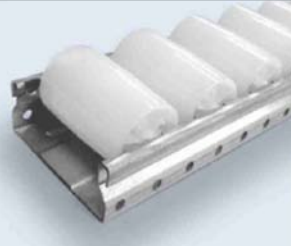

Makaralı Ray  
Roller Guide

**GP70**



Makaralı Ray  
Roller Guide

**GP70B**



Makaralı Ray  
Roller Guide

**GR70B**



Makaralı Ray  
Roller Guide

Hedef  
"Yalın" üretim

Goal  
"Lean" manufacturing



**GR70**



Makaralı Ray  
Roller Guide

**GR85**



Makaralı Ray  
Roller Guide





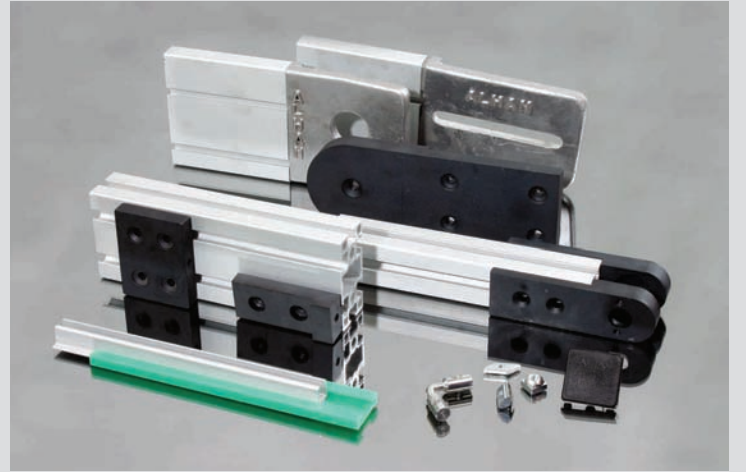





**ÇAĞRI**<sup>®</sup>  
ENDÜSTRİ A.Ş.

**ALHAN**<sup>®</sup>

- ÜRETİMDEN SATIŞ
- FROM PRODUCTION TO SALES

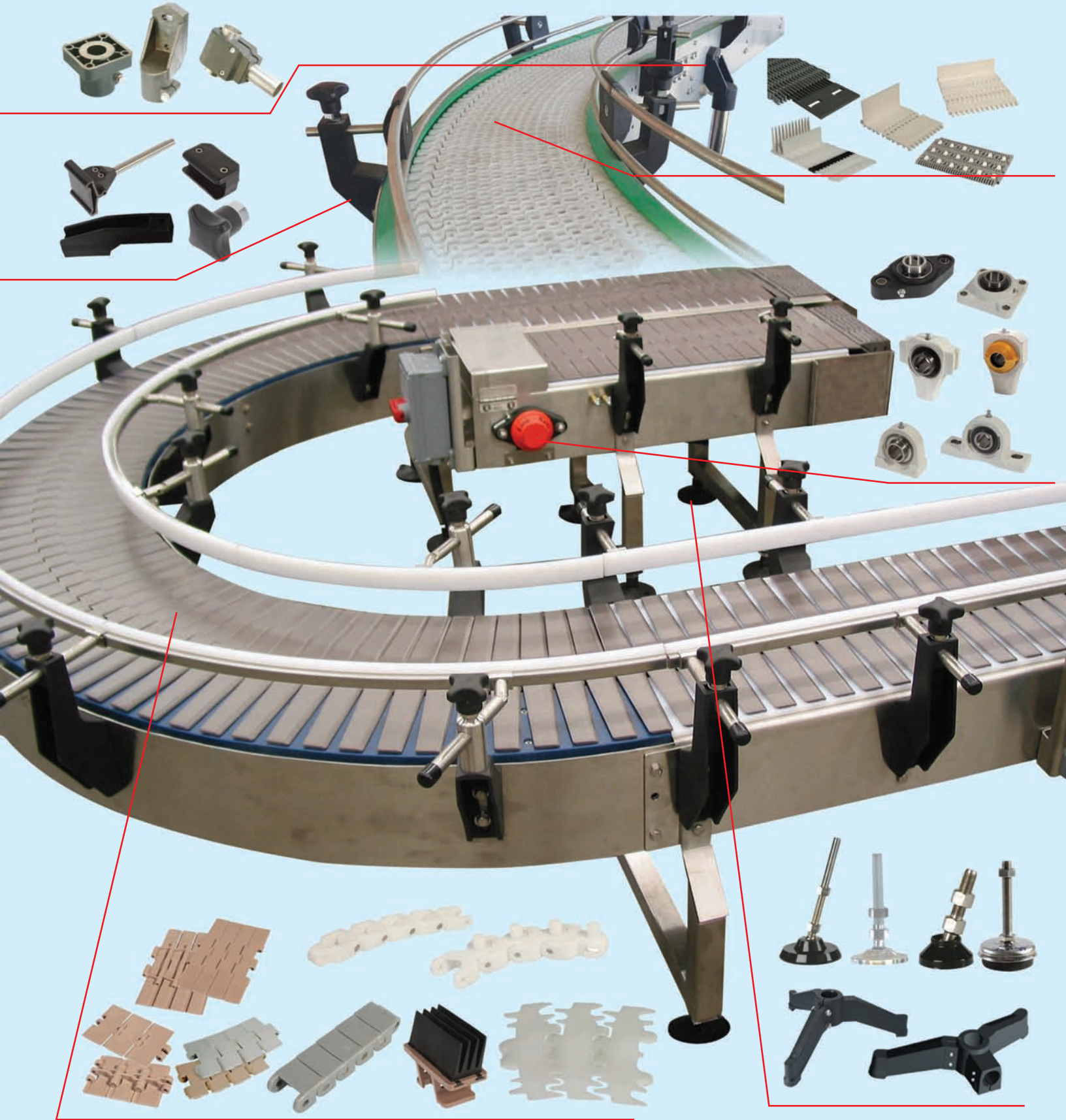



Kimyasal Dirençler Chemical Resistance Temperatures up to 65°C 65°C'ye Kadar	Polyamid Polyamide	Çelik Steel	Paslanmaz Çelik Stainless Steel AISI 304	Paslanmaz Çelik Stainless Steel AISI 430	Düşük Sürtümlü Asetal LF Acetal (POM)	ALPOLEN® 1000 UHMW	Polipropilen Polypropylene (PP)
Aseton Acetone	+	-	+	+	+	+	+
Asedik Asit Acetic Acid (max.5%)	-	-	+	-	-	+	+
Sitrik Asit Citric Acid	0	-	+	0	0	+	0
Formik Asit Formic Acid	-	+	+	+	-	+	+
Fosforik Asit Phosphoric Acid (max.10%)	-	-	+	-	-	+	+
Hidroklorik Asit Hydrochloric Acid (max.2%)	-	-	-	-	-	+	+
Laktik Asit Lactic Acid	+	-	+	-	+	+	+
Nitrik Asit Nitric Acid	-	-	+	0	-	0	+
Sülfid Asit Sulphide Acid	-	-	-	-	-	-	+
Yağ Oil (vegetable or mineral)	+	+	0	+	+	+	+
Sabun Soap and water	+	0	+	+	+	+	+
Tatlı Su Water	+	-	+	+	+	+	+
Deniz Suyu Sea water	-	0	+	0	+	+	+
Alkol Alcohol	+	+	+	+	+	+	+
Amonyak Ammonia	+	0	+	+	-	+	+
Alkolsüz İçki Soft drinks	+	+	+	+	+	+	+
İspirto Spirits	+	+	+	+	+	+	+
Benzen Benzene	+	+	+	+	+	0	-
Benzol Benzol	+	+	+	+	+	+	0
Bira Beer	+	+	+	+	+	+	+
Çikolata Chocolate	0	+	+	+	0	0	+
Sodyum Hidroklorid Sodium Hydrochloride	+	-	0	-	+	+	+
Petrol Petrol	+	+	+	+	+	0	+

Kimyasal Dirençler Chemical Resistance Temperatures up to 65°C 65°C'ye Kadar	Polyamid Polyamide	Çelik Steel	Paslanmaz Çelik Stainless Steel AISI 304	Paslanmaz Çelik Stainless Steel AISI 430	Düşük Sürtümlü Asetal LF Acetal (POM)	ALPOLEN® 1000 UHMW	Polipropilen Polypropylene (PP)
Sodyum Hidroksid Sodium hydroxide (max.25%)	+	-	+	+	-	+	+
Sodyum Hipoklorid Sodium hypochlorite	+	-	-	-	-	+	+
Meyve Suyu Fruit Juices	+	-	+	0	+	+	+
Sebze Suyu Juices vegetable	+	0	+	+	+	+	+
Süt Milk	+	+	+	+	+	+	+
Hardal Mustard	0	+	+	+	+	0	+
Parafin Paraffin	+	+	+	+	+	+	0
Hidrojen Peroksit Hydrogen peroxide	-	-	+	0	-	0	+
Karbon Tetraklorid Carbon tetrachloride	+	0	0	0	+	0	-
Toluene	-	-	-	-	+	0	+
Turpentin Turpentine	-	+	+	+	-	0	+
Sirke Vinegar	+	-	0	-	+	+	+
Şarap Wine	+	+	+	+	+	+	+
Viski Whisky	+	+	+	+	+	+	+
Lodine	-	0	0	0	0	0	0
Xilol	-	-	-	-	-	-	-

**+** = İyi / Good

**0** = Orta / Average

**-** = Yetersiz / Unsatisfactory

Yukarıda belirtilen değerler firma tecrübesine dayalı olup garanti niteliği taşımamaktadır.

Malzemeler ve ürünler çalışma şartları doğrultusunda test edilerek uygun koşullar saptanmalıdır.

Ürünlerimizin Mekanik Analizleri SOLID WORKS Programında yapılmaktadır.

This information may be considered as a basis for recommendation, but not as a guarantee.

Materials and products should be tested under exact intended service conditions

to determine their suitability for a particular purpose.

Mechanical Analysis of products on SOLID WORKS



## MALZEME UYGUNLUK KODU MATERIAL SUITABILITY CODE

- R = Tavsiye edilir/Recommended**  
**NR = Tasviye Edilmez/Not Recommended**  
**Q = Kuşkulu/Questionable**  
**— = Bilgi Mevcut değil/No Available Information**

KİMYASALIN ADI CHEMICAL NAME	STANDART MALZEMELER/STANDARD MATERIALS							
	PP		PE		POM		PP <small>Isıya Dayanıklı</small> Heat Resistant	
	(21 °C)	(60 °C)	(21 °C)	(60 °C)	(21 °C)	(60 °C)	(21 °C)	(60 °C)
Asetik Asit / Acetic Acid	R	R	R	Q	—	—	NR	NR
Acetic Acid - %5 /Asetik Asit - % 5	R	R	R	R	R	—	NR	NR
Aseton / Acetone	R	R	R	R	Q	Q	R	R
Alcehol - Tüm Türleri / Alcehol - All Types	R	R	R	R	—	—	R	R
Şap - Tüm Türleri / Alum - All Types	R	R	R	R	—	—	—	Q
Alüminyum Bileşikler / Aluminum Compounds	R	R	R	R	—	—	R	R
Amonyak / Ammonia	R	R	R	R	—	—	R	R
Amonyum Bileşikleri / Ammonium Compounds	R	R	R	R	—	—	R	Q
Amonyum Bileşikleri / Ammyl Acetate	Q	NR	Q	NR	—	—	N	R
Ammyl Klorür / Ammyl Chloride	NR	NR	Q	NR	—	—	—	—
Anilin / Aniline	R	R	R	NR	—	Q	—	Q
Aqua Regia / Aqua Regia	NR	NR	Q	NR	—	—	NR	—
Arsenik Asit / Arsenic Acid	R	R	R	R	—	—	—	—
Baryum Bileşikleri / Barium Compounds	R	R	R	R	—	—	R	R
Baryum Sabun Gres / Barium Soap Grease	R	Q	—	—	—	—	—	—
Bira / Beer	R	R	R	R	—	—	—	R
Benzen / Benzene	Q	NR	Q	NR	R	Q	R	R
Benzenesulfonic Asit -% 10 / Benzenesulfonic Acid - %10	R	R	R	R	—	—	—	R
Benzoik Asit / Benzoic Acid	R	R	R	R	—	—	Q	R
Boraks / Borax	R	R	R	R	—	—	—	—
Borik Asit / Boric Acid	R	R	R	R	—	—	R	Q
Fren Sıvısı / Brake Fluid	R	R	—	—	R	R	R	R
Salamura -% 10 / Brine - %10	R	R	R	R	R	R	—	—
Bromik Asit / Bromic Acid	NR	NR	NR	NR	—	—	NR	—
Brom - Duman Sıvı / Bromine - Liquid of Fumes	NR	NR	NR	NR	—	—	NR	—
Brom Su / Bromine Water	NR	NR	Q	NR	—	—	R	R
Bütül Asetat / Butyl Acetate	NR	NR	R	Q	—	—	—	—
Bütül Akrlat / Butyl Acrylate	R	—	R	Q	—	—	Q	R
Butirik Asit / Butyric Acid	R	R	R	R	—	—	Q	—
Kalsiyum Bileşikleri / Calcium Compounds	R	Q	—	—	—	—	—	—
Kalsiyum Sabun Gres / Calcium Soap Grease	R	R	—	—	R	R	—	—
Calgonite -% 0.3 / Calgonite - 0.3%	R	R	R	R	—	—	R	R
Karbondioksit / Carbon Dioxide	Q	NR	Q	NR	—	—	R	R
Karbon Disülfid / Carbon Disulfide	NR	NR	NR	NR	R	Q	R	R
Karbon Tetraklorür / Carbon Tetrachloride	R	R	—	—	—	—	—	—
Cellosolve - TM / Cellosolve - TM	R	R	—	—	—	—	—	NR
Chloroasetik Asit / Chloroacetic Acid	NR	NR	Q	NR	NR	NR	—	NR
Klor Gaz / Chlorine - Gas	NR	NR	NR	NR	NR	NR	NR	NR
Klor Sıvı / Chlorine - Liquid	R	Q	R	Q	NR	NR	—	NR
Klor Su (% 0,4 Cl) / Chlorine Water (0.4% Cl)	NR	NR	Q	NR	—	—	R	R
Klorobenzen / Chlorobenzene	NR	NR	NR	NR	—	—	Q	—
Kloroform / Chloroform	NR	NR	NR	NR	—	—	NR	NR
Chlorosufonic Asit / Chlorosufonic Acid	R	R	R	Q	—	—	NR	—
Kromik Asit - 50% / Chromic Acid - 50%	R	R	R	R	—	—	—	R
Sitrik Asit / Citric Acid	R	R	R	R	R	—	R	R
Sitrik Asit% 10 / Citric Acid 10%	R	R	R	R	—	—	R	R
Narenciye Suları / Citrus Juices	R	Q	—	—	NR	NR	—	NR
Clorox - TM / Clorox - TM	R	R	R	R	—	—	—	—
Hindistan Cevizi Yağı / Coconut Oil	R	R	R	R	—	—	Q	—
Bakır Bileşikler / Copper Compounds	R	R	R	R	—	—	—	—
Mısır Yağı / Corn Oil	R	R	R	R	—	—	—	—
Pamuk Yağı / Cottonseed Oil	R	R	R	Q	—	—	NR	NR
Kresol / Cresol	R	Q	NR	NR	—	—	—	—
Sikloheksan / Cyclohexane	R	Q	Q	NR	—	—	R	—
Sikloheksanole / Cyclohexanol	R	Q	NR	NR	—	—	R	—
Sikloheksanon / Cyclohexanone	R	R	R	R	R	R	R	—
Deterjanlar / Detergents	R	R	R	R	—	—	—	—
Dekstrin / Dextrin	R	Q	—	—	—	—	R	R
Ftalat Dibütül / Dibutyl Phthalate	NR	NR	NR	NR	Q	Q	R	R
Dietyl Eter / Diethyl Ether	R	R	—	NR	—	—	R	—
Diethylamin / Diethylamine	R	R	R	R	—	—	—	—
Diglycolic Asit -% 30 / Diglycolic Acid - %30	R	R	—	—	—	—	—	—
Diisooctyl Ftalat / Diisooctyl Phthalate	R	R	—	—	—	—	—	—
Ftalat dimetil / Dimethyl Phthalate	R	—	—	—	—	—	R	R
Dimethylamine / Dimethylamine	R	Q	—	—	—	—	R	R

## MALZEME UYGUNLUK KODU MATERIAL SUITABILITY CODE

- R = Tavsiye edilir/Recommended**  
**NR = Tasviye Edilmez/Not Recommended**  
**Q = Kuşku/Kuestionable**  
**— = Bilgi Mevcut değil/No Available Information**

KİMYASALIN ADI CHEMICAL NAME	STANDART MALZEMELER/STANDARD MATERIALS							
	PP		PE		POM		PP Isıya Dayanıklı Heat Resistant	
	(21 °C)	(60 °C)	(21 °C)	(60 °C)	(21 °C)	(60 °C)	(21 °C)	(60 °C)
Diglycolic Asit -% 30 / Diglycolic Acid - %30	R	R	Q	Q	Q	NR	R	R
Diisooctyl Ftalat / Diisooctyl Phthalate	Q	Q	—	—	—	—	—	—
Ftalat dimetil / Dimethyl Phthalate	R	R	—	—	—	—	—	—
Dimethylamine / Dimethylamine	NR	NR	—	—	—	—	—	—
Dioktil Ftalat / Dioctyl Phthalate	R	R	R	R	R	Q	R	Q
Etil Asetat / Ethyl Acetate	R	R	R	R	—	—	Q	—
Etil Eter / Ethyl Ether	R	R	R	Q	—	—	—	—
Ethylamine / Ethylamine	R	Q	R	Q	—	—	NR	NR
Etilen Klorür / Ethylene Chloride	—	—	R	R	Q	Q	—	—
Etilen glikol -% 50 / Ethylene Glycol - %50	R	Q	R	NR	Q	Q	R	R
Ferrik - Demirli Bileşikler / Ferric - Ferrous Compounds	NR	NR	Q	NR	—	—	R	—
Formaldehit -% 37 / Formaldehyde - 37%	Q	NR	R	NR	R	R	R	R
Formik Asit - 85% / Formic Acid - 85%	R	R	R	R	—	—	—	—
Freon / Freon	R	R	—	—	—	—	R	R
Fuel Oil # 2 / Fuel Oil #2	NR	NR	Q	NR	R	R	R	R
Furfural / Furfural	R	Q	NR	NR	—	—	R	R
Benzin / Gasoline	R	R	R	R	—	—	NR	NR
Glikoz / Glucose	R	R	R	R	NR	NR	NR	NR
Gliserin / Glycerol	R	R	R	R	NR	NR	NR	NR
Heptan / Heptane	R	R	R	R	NR	NR	NR	NR
Hekzan / Hexane	R	R	R	R	R	R	Q	Q
Hidrobromik Asit -% 50 / Hydrobromic Acid - 50%	Q	Q	R	Q	—	—	NR	NR
Hidrobromik Asit / Hydrobromic Acid	R	R	R	R	—	—	R	R
Hidroklorik Asit -% 10 / Hydrochloric Acid - 10%	NR	NR	—	—	—	—	—	—
Hidroflorik Asit -% 35 / Hydrofluoric Acid - 35%	R	R	—	—	R	R	—	—
Hidrojen Peroksit -% 3 / Hydrogen Peroxide - 3%	R	R	Q	Q	—	—	—	NR
Hidrojen Peroksit - 90% / Hydrogen Peroxide - 90%	NR	NR	R	—	—	—	R	R
Hidrojen Sülfür / Hydrogen Sulfide	Q	NR	Q	Q	R	R	R	R
Hidroiyodik Asit / Hydroiodic Acid	Q	NR	Q	Q	R	R	R	—
Igepal -% 50 / Igepal - 50%	R	R	R	R	—	—	NR	NR
İyot - Kristaller / Iodine - Crystals	R	Q	R	R	—	—	—	—
İzooktan / Isooctane	—	—	R	R	—	—	—	R
Jet Yakıtı / Jet Fuel	R	R	R	R	—	—	—	—
Gazyağı / Kerosene	R	R	R	R	—	—	R	R
Laktik Asit / Lactic Acid	Q	NR	Q	NR	—	—	—	—
Lanolin / Lanolin	Q	NR	—	—	—	—	—	—
Domuz Yağı / Lard	R	—	—	—	—	—	—	—
Laurik Asit / Lauric Acid	R	R	R	R	R	R	R	R
Kurşun Asetat / Lead Acetate	R	Q	—	—	R	R	R	Q
Limon Yağı / Lemon Oil	R	R	R	R	—	—	Q	—
Ligroin / Ligroin	R	R	R	R	—	—	R	R
Kireç Sülfür / Lime Sulfur	R	—	R	R	—	—	Q	Q
Keten Yağı / Linseed Oil	R	R	R	R	—	—	—	—
Makine Yağı / Lubricating Oil	R	R	R	R	—	—	—	—
Magnezyum Bileşikleri / Magnesium Compounds	R	R	R	R	—	—	R	—
Malik Asit -50% / Malic Acid -50%	R	—	—	—	—	—	—	—
Manganez Sülfat / Manganese Sulfate	NR	NR	—	—	—	—	—	N
Margarin / Margarine	R	Q	NR	NR	—	—	R	—
Civa Bileşikleri / Mercuric Compounds	R	Q	—	—	—	—	—	—
Merkür / Mercury	Q	NR	NR	NR	—	—	Q	Q
Metil Cellosolve / Methyl Cellosolve	R	R	R	R	—	—	—	—
Metil Klorür / Methyl Chloride	Q	NR	R	NR	R	R	—	—
Metil Etil Keton / Methyl Ethyl Ketone	Q	NR	—	—	—	—	R	—
Metil ISOBUTYL Keton / Methyl Isobutyl Ketone	R	R	R	R	—	—	R	R
Metilen Klorür / Methylene Chloride	R	Q	—	—	R	R	R	R
Methylsulfuric Asit / Methylsulfuric Acid	R	Q	Q	NR	—	—	R	R
Madeni Yağ / Mineral Oil	R	R	R	R	—	—	Q	—
Mineral Spirits / Mineral Spirits	R	Q	R	R	NR	NR	NR	NR
Melas / Molasses	Q	NR	R	Q	NR	NR	NR	NR
Motor Yağı / Motor Oil	NR	NR	NR	NR	NR	NR	NR	NR
Naphtta / Naphtta	R	Q	NR	NR	—	—	Q	—
Nikel Bileşikler / Nickel Compounds	Q	NR	—	—	—	—	—	—
Nitrik Asit% 30 / Nitric Acid - 30%	R	—	—	—	—	—	—	—
Nitrik Asit% 50 / Nitric Acid - 50%	R	NR	—	—	R	R	R	R
Nitrik Asit - Tütsülenmiş / Nitric Acid - Fuming	R	R	R	R	—	—	—	—



## MALZEME UYGUNLUK KODU MATERIAL SUITABILITY CODE

- R = Tavsiye edilir/Recommended**  
**NR = Tasviye Edilmez/Not Recommended**  
**Q = Kuşkulu/Questionable**  
**— = Bilgi Mevcut değil/No Available Information**

KİMYASALIN ADI CHEMICAL NAME	STANDART MALZEMELER/STANDARD MATERIALS							
	PP		PE		POM		PP Isıya Dayanıklı Heat Resistant	
	(21 °C)	(60 °C)	(21 °C)	(60 °C)	(21 °C)	(60 °C)	(21 °C)	(60 °C)
Zeytinyağı / Olive Oil	R	R	R	R	—	—	Q	—
Oksalik Asit / Oxalic Acid	NR	NR	—	—	—	—	R	R
Oksijen / Oxygen	NR	NR	Q	NR	—	—	Q	Q
Ozon / Ozone	R	R	R	R	—	—	R	R
Palmitik Asit -% 70 / Palmitic Acid - 70%	R	R	—	—	—	—	—	—
Fıstık Yağı / Peanut Oil	R	R	R	R	—	—	—	—
Perklorik Asit -% 20 / Perchloric Acid - 20%	NR	NR	NR	NR	—	—	Q	NR
Perchloroethylene / Perchloroethylene	R	R	R	R	—	—	—	—
PhenolPhthalic Asit -% 50 / PhenolPhthalic Acid - 50%	R	R	R	R	NR	NR	NR	NR
Fenol -% 5 / Phenol - 5%	R	R	R	R	NR	NR	NR	NR
Fosforik Asit% 30 / Phosphoric Acid - 30%	R	R	R	R	—	—	NR	NR
Fosforik Asit% 85 / Phosphoric Acid - 85%	R	R	R	R	—	—	NR	NR
Fotografik Çözümler / Photographic Solutions	R	R	R	R	—	—	R	—
Kaplama Çözümleri / Plating Solutions	R	R	R	R	—	—	—	—
Potasyum Bileşikleri / Potassium Compounds	R	R	R	R	—	—	R	—
Potasyum Hyderoxide / Potassium Hyderoxide	R	R	R	R	—	—	R	—
Potasyum Lodide (% 3 Lodide) / Potassium Lodide (3% Lodide)	R	R	R	R	—	—	—	—
Potasyum / Potassium	R	Q	R	R	—	—	NR	NR
Permanganat / Permanganate	R	R	—	—	—	—	—	—
Siyanür Gümüş / Silver Cyanide	R	R	R	R	—	—	—	—
Gümüş Nitrat / Silver Nitrate	R	R	R	R	—	—	Q	—
Sodyum Bileşikleri / Sodium Compounds	R	Q	R	R	—	—	Q	NR
Sodyum Klorit / Sodium Chlorite	R	R	R	R	—	—	R	NR
Sodyum Hidroksit / Sodium Hydroxide	R	R	R	R	R	R	R	NR
Sodyum Hidroksit -% 60 / Sodium Hydroxide - 60%	R	Q	—	—	NR	NR	NR	—
Kalaysı Klorür / Stannic Chloride	R	R	R	R	—	—	—	—
Kalay Klorür / Stannous Chloride	R	R	R	R	—	—	—	—
Stearik Asit / Stearic Acid	R	Q	R	R	—	—	R	R
Süksinik Asit / Succinic Acid	R	R	R	R	—	—	—	—
Şeker / Sugar	R	R	R	R	—	—	—	—
Sülfamik Asit -% 20 / Sulfamic Acid - 20%	R	R	—	—	NR	NR	—	—
Sülfat Likörler / Sulfate Liquors	R	R	—	—	—	—	—	—
Kükürt / Sulfur	R	R	R	R	—	—	R	R
Kükürt Klorür / Sulfur Chloride	R	—	—	—	—	—	—	—
Kükürt Dioksit / Sulfur Dioxide	R	R	R	R	—	—	R	Q
Sülfürik Asit -% 3 / Sulfuric Acid - 3%	R	R	R	R	R	R	NR	NR
Sülfürik Asit - 50% / Sulfuric Acid - 50%	R	R	R	R	NR	NR	NR	NR
Sülfürik Asit - 70% / Sulfuric Acid - 70%	R	Q	R	Q	NR	NR	NR	NR
Sülfürik Asit - Tütsülenmiş / Sulfuric Acid - Fuming	NR	NR	NR	NR	NR	NR	NR	NR
Sülfirik Asit / Sulfurous Acid	R	—	R	R	—	—	Q	Q
Donyağı / Tallow	R	R	R	Q	—	—	R	R
Tannik Asit -% 10 / Tannic Acid - 10%	R	R	R	R	—	—	—	—
Tartarik Asit / Tartaric Acid	R	R	R	R	—	—	Q	Q
Tetrahydrofuran / Tetrahydrofuran	Q	NR	—	—	—	—	R	—
Toluene / Tolüen	NR	NR	NR	NR	Q	NR	R	R
Domates Suyu / Tomato Juice	R	R	R	R	—	—	—	—
Trafo Yağı / Transformer Oil	R	Q	R	Q	—	—	R	R
Tributyl Fosfat / Tributyl Phosphate	R	Q	—	—	—	—	—	—
Trikloroasetik Asit / Trichloroacetic Acid	R	R	—	—	—	—	R	NR
Trikloretilen / Trichloroethylene	NR	NR	NR	NR	—	—	R	NR
Tricresyl Phosphate / Tricresyl Phosphate	R	Q	—	—	—	—	—	—
Trisodyum Phosphate / Trisodium Phosphate	R	R	R	R	—	—	—	—
Terebentin / Turpentine	Q	NR	Q	NR	—	—	R	R
Üre / Urea	R	R	R	R	—	—	R	R
Sirke / Vinegar	R	R	R	R	—	—	—	—
Şarap / Wine	R	R	R	R	—	—	R	R
Ssilen / Xylene	NR	NR	NR	NR	—	—	R	R
Çinko Bileşikleri / Zinc Compounds	R	R	R	R	—	—	Q	—



**ÇAĞRI**<sup>®</sup>  
ENDÜSTRİ A.Ş.

**ALHAN**

Konveyör ve Parçaları , Mühendislik Plastikleri

## ALHAN Hasır Bant Uygulamaları için Teknik Veri Formu

Şirket / Müşteri : .....

İlgili Kişi : .....

İletişim Telefon : ..... e-posta : .....

### Teknik Veri:

Endüstri:										
Uygulama:										
Ürün tipi:										
Kapak / konteyner:										
Ürün ölçüleri:	xW:	mm	xL:	mm	xH:	mm				
Ürün ağırlığı:	kg		kg/metre		kg/m. kare					
Konveyör hızı:										
Bant genişliği:	mm									
Bant uzunluğu:	mm									
Bant hatvesi:	mm									
Minimum / maksimum ortam sıcaklığı:		C /		C /						
Kimyasal temas:	<input type="checkbox"/>	Evet, tür:		<input type="checkbox"/>	Hayır					
Konveyör Türü:	<input type="checkbox"/>	Yatay	<input type="checkbox"/>	Dikey	<input type="checkbox"/>	Z Tip	<input type="checkbox"/>	L Tip	<input type="checkbox"/>	Eğimli
	<input type="checkbox"/>	Spiral	<input type="checkbox"/>	Dönüştü						
Bant Rengi :										
Malzeme :	<input type="checkbox"/>	PP	<input type="checkbox"/>	POM						
Pim malzeme:	<input type="checkbox"/>	PP	<input type="checkbox"/>	PA	<input type="checkbox"/>	SS				
Götürücü:	<input type="checkbox"/>	+	<input type="checkbox"/>	-						
Götürücü yüksekliği:	mm		Yan boşluk :	mm	Ara mesafe :	mm				
Dişliçapı / diş sayısı :	mm / Z									
Dişli göbeği:										

Tarih: ...../...../20.....

İmza

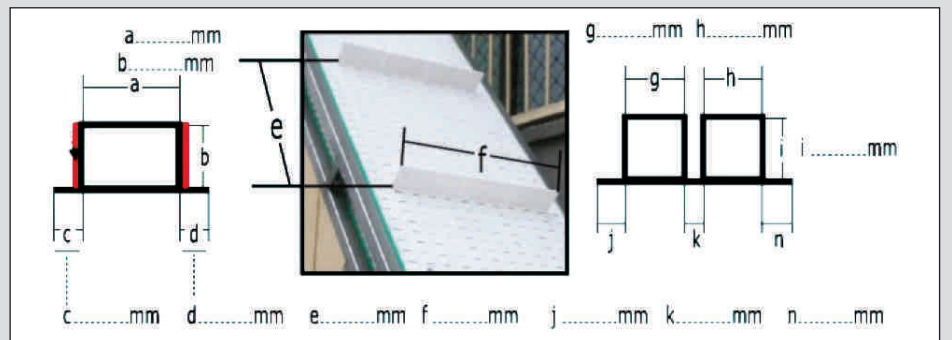



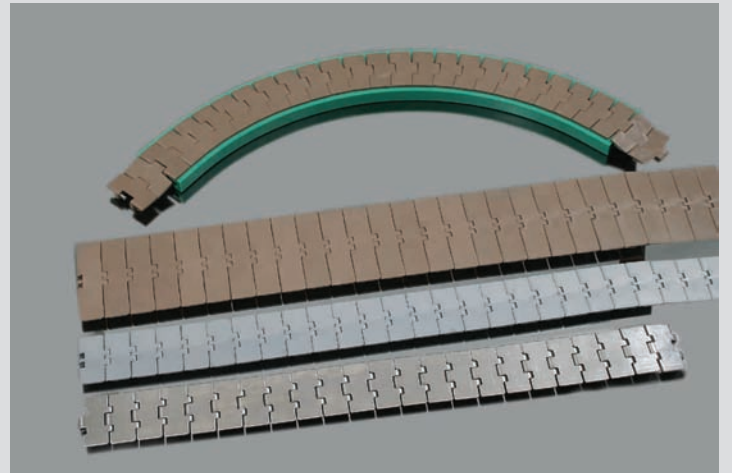
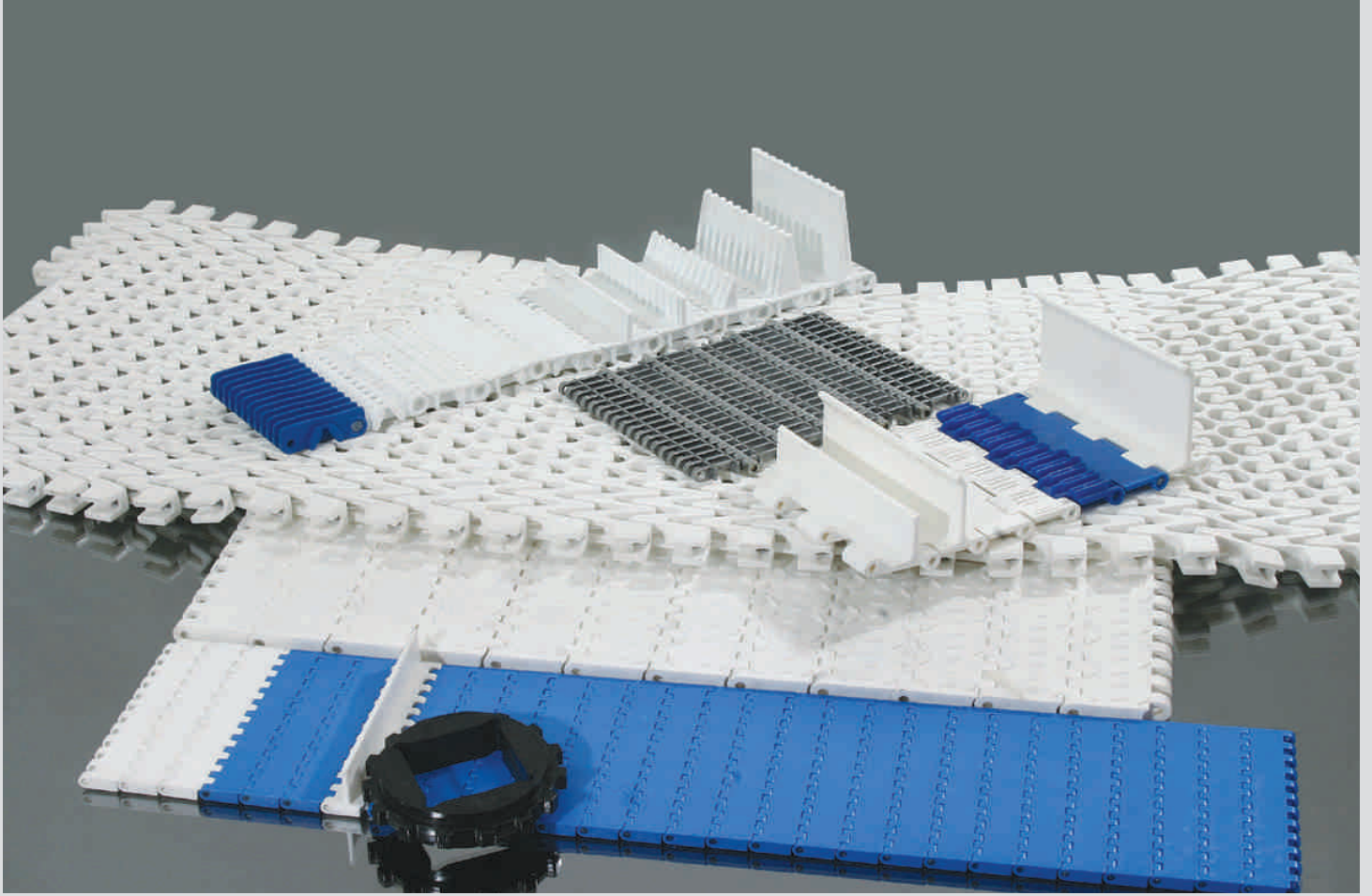



**ÇAĞRI**<sup>®</sup>  
ENDÜSTRİ A.Ş.

**ALHAN**<sup>®</sup>

Davutpaşa Cad. Nu: 14/1

34010 Topkapı - İSTANBUL - TÜRKİYE

Tel: +90 212 444 00 42 - 544 50 55

Belgegeçer (Fax): +90 212 567 14 16 - 501 54 08

e-posta (e-mail) : info@alhan-cagri.com

www.alhan-cagri.com

+90 532 934 85 02

